

OUTDOOR



is part of PENTA Group 





**OUTDOOR**







360°

LIGHTING

SOLUTION

## WE ARE PENTA LIGHT

The decorative yet contemporary design by Penta, the technical indoor and outdoor lighting by Castaldi, the Masters' collections by Arredoluce. The fusion of these three outstanding companies in the lighting world gave birth to Penta Group: three brands, each with a strong characterization, three design approaches sharing the idea of finding a synthesis between functionality, technology and beauty.

*Il design tra decorazione e contemporaneità di Penta, l'illuminazione tecnica indoor e outdoor di Castaldi, le grandi firme di Arredoluce. Dalla fusione di tre realtà d'eccellenza del mondo dell'illuminazione è nato Penta Group: tre brand, ciascuno con la propria autonomia, per approcci progettuali accomunati dall'idea di trovare una sintesi tra funzionalità, tecnologia e bellezza.*







# LIGHT IS OUR MISSION



**More than 80 years  
of experience in  
technical indoor and  
outdoor lighting.**

**Più di 80 anni di esperienza  
nell'illuminazione tecnica  
indoor e outdoor.**

# In 1938

Engineer Enrico Castaldi founds the company under his own name and over for over 80 years he will be able to express himself in the world of Italian design like no other. Castaldi has been an innovator since 1970s when it launched its first architectural lighting products onto the market, becoming the pioneer of a new outdoor lighting concept. For some time now, Castaldi has been one of the major players in the upper echelons of the international market, capable of offering the widest range of lighting products, characterised by high performance, refined design and technological innovation.

*Nel 1938 l'Ingegnere Enrico Castaldi fonda la sua omonima azienda e nel corso degli 80 anni saprà esprimersi nel mondo del design italiano come nessun'altro. Castaldi è l'innovatore nel settore dell'illuminazione, dagli anni '70 introduce nel mercato i primi prodotti di illuminazione architettonica, facendosi pioniere di un nuovo concetto e modo di illuminare gli spazi esterni. Castaldi è da tempo uno dei principali player del mercato internazionale di fascia alta ed in grado di offrire la più ampia gamma di apparecchi d'illuminazione caratterizzati sempre da elevata performance, design ricercato e tecnologia innovativa.*



**History and tradition, the roots that feed our products research and development activity, carried out fully respecting our company mission: “never copy, always innovate”. All products, all strictly made in Italy, are the best witness of it.**

**Storia e tradizione sono le radici che nutrono l’attività di sviluppo, attuata nel rispetto della mission aziendale, sintetizzata in una semplice regola: “non copiare - innovare”. I prodotti rigorosamente made in Italy, sono la migliore testimonianza.**



# SINCE 1938

Engineer Enrico Castaldi  
founds the company under  
his own name.

*Enrico Castaldi fonda  
la omonima Azienda.*



1938

"Egeo" is born, forerunner  
of the famous models still  
in production.

*Nasce "Egeo" antesignano  
dei famosi modelli tuttora  
in produzione.*



1970

1946



The company specialises in  
watertight and explosion-pro-  
of lighting appliances for the  
industry, (mainly chemical).

*L' Azienda si specializza in  
apparecchiature stagne e  
antideflagranti per l'industria  
prevalentemente chimica.*

1960



The son of Enrico Castaldi,  
Giorgio joins the company.

*Entra in azienda il figlio  
Giorgio Castaldi.*

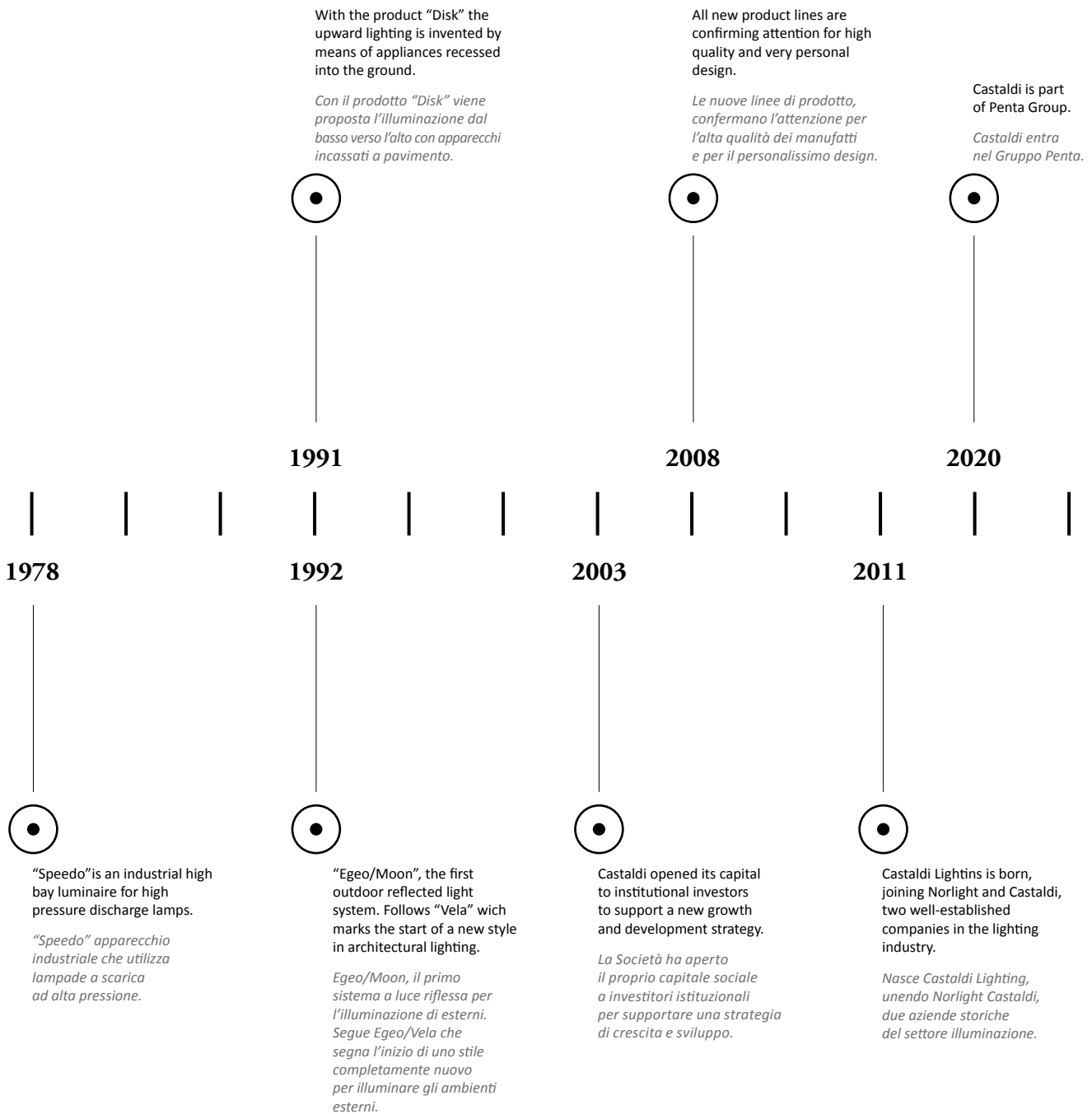

# 360° TECHNICAL LIGHTING

Throughout its history, Castaldi has achieved a solid and recognized position in the various Indoor, Outdoor and Urban fields, offering a 360° technical lighting solution.

*Nel corso della sua storia, Castaldi ha conquistato una solida e riconosciuta posizione nei vari campi Indoor, Outdoor e Urban, offrendo una soluzione tecnica a 360°.*



**OUTDOOR**



**INDOOR**



**URBAN**

# LIGHTING PROJECTS





# HOSPITALITY



Luxury Design Hotel Tel Aviv, Israel



Elements Studio Henninger Turm Frankfurt, Germany

# PUBLIC AREAS



Abu Dhabi International Airport Abu Dhabi, UAE



The Vessel New York, USA

# RETAIL



Stone Island Store Milan, Italy



Poliform Showroom Tunis, Tunisia

# RESIDENTIAL



Villa Lario Lecco, Italy



Apartment City Life Milan, Italy



Private House Modena, Italy

**WE WORKED WITH**

A++

Adolfo Natalini

Alfonso Femia

Anselm von Held

Arnaldo Pomodoro

Arquitectonica International Corporation

Aurelio Cortesi

BMMC

Benoy Architects

Bertil Schroder

Cino Zucchi

Daniel Libeskind

Danilo Guerri

Davide Vargas

Diego Nakamatsu

DP. Architects Gensler

Farnush Davarpanah

Fausto Colombo

Gae Aulenti

Gianluca Peluffo

HABIT(S)

Isotta Cortesi

Joerg Krewinkel

KPF Kohn Pedersen Fox Associates

Lorenzo Forges Davanzati

Lucchesedesign

Mario Bellini

Marco Ciarlo

Massimiliano Fuksas

Norman Foster

Park Associati

Pierluigi Cerri

Piero Castiglioni

Rodolfo Oggioni

Sardellini Marasca Architetti

Stefano Boeri

Studio Isolarchitetti

TAMassociati

UNA2 Architetti Associati

Vittorio Gregotti

# INDEX

## HERITAGE



	<b>BLOCK</b>	p. 26
	<b>EGEO/N2</b>	p. 32
	<b>MINISOSIA</b>	p. 40
	<b>VENEZIA</b>	p. 50



	<b>BOXER/T</b>	p. 28
	<b>GULLIVER</b>	p. 36
	<b>SOSIA</b>	p. 42



	<b>DIABLO</b>	p. 30
	<b>LUCILLA</b>	p. 38
	<b>TORTUGA</b>	p. 48

## GROUND





### Recessed



	<b>ICE</b>	p. 54
	<b>NASTER</b>	p. 62
	<b>TELLUX</b>	p. 72

	<b>INDICO</b>	p. 58
	<b>PASSO</b>	p. 66
	<b>TELLUX LARGE</b>	p. 78

	<b>IRIDE</b>	p. 60
	<b>TELLUX SMALL</b>	p. 68

### Bollard



	<b>FLOAT</b>	p. 84
	<b>NASTER</b>	p. 92
	<b>TAU</b>	p. 98
	<b>ZACK</b>	p. 104

	<b>KEA</b>	p. 86
	<b>PLANO</b>	p. 94
	<b>USEPARTOUT SUPERSTONE</b>	p. 100

	<b>MINIZACK</b>	p. 90
	<b>POLO</b>	p. 96
	<b>VERY</b>	p. 102

## WALL

### Recessed





	<b>ICE</b>	p. 108
	<b>THOR</b>	p. 114

	<b>NASTER</b>	p. 110
---	---------------	--------

	<b>TELLUX SMALL</b>	p. 112
---	-------------------------	--------

### Surface

	<b>BOOK</b>	p. 120
	<b>DUETTO</b>	p. 132
	<b>ICE</b>	p. 138
	<b>PLANO</b>	p. 148
	<b>UPSTER</b>	p. 154

	<b>BOX</b>	p. 122
	<b>DUPLO/Q</b>	p. 134
	<b>KEA</b>	p. 140
	<b>SLIM</b>	p. 150
	<b>USEPARTOUT SUPERFLAT</b>	p. 158

	<b>CHIARO</b>	p. 126
	<b>FILO FLEX</b>	p. 136
	<b>MINIZACK</b>	p. 146
	<b>TEMA CITY</b>	p. 152
	<b>VERY</b>	p. 162



## CEILING

### Recessed

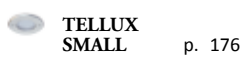
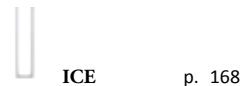

### Surface

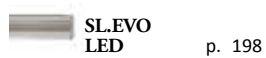

### Pendant



## SPOTLIGHT

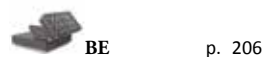

## HANDRAIL



## UNDERWATER



## POLES

p. 250

## PROFILES



## HIGH TECHNOLOGY STRIPS

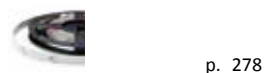

## EASY LINES STRIPS



## POWER SUPPLIES AND CONTROLS



## PRODUCT CONFIGURATOR

p. 338

# HERITAGE



PRODUCTION START  
*INIZIO PRODUZIONE*  
1984

Please visit website  
*Visita il sito internet*



# BLOCK

DESIGN BY CASTALDI

Sample code  
*Codice d'esempio*

**D08/LWW-GR**



Golf and country club - Castello di Tolcinasco (MI) Italy  
Project: Arch. Luisa Cortese

**Sturdy and versatile fixture for recessed application.**

Designed to last a long time, the block range, almost "anonymous" in its formal cleanness, is the tangible example of our severe design concepts and our ethical tradition. Block does the job of lighting in an effective, safe and economic way. It can be used outdoor or indoor, recessed or projected from wall or ceiling.

***Apparechio da incasso robusto e versatile.***

*Block assolve in modo esemplare al compito di illuminare in modo efficace, sicuro ed economico: può essere utilizzato in esterni o interni, incassato o sporgente, a parete o a soffitto.*

*Concepita per durare a lungo, la serie block, quasi 'anonima' nella sua pulizia formale, è l'esempio tangibile dei nostri severi concetti costruttivi e della nostra tradizione etica.*



PRODUCTION START  
*INIZIO PRODUZIONE*

2004

AWARDS  
*PREMI*

**Premio Intel Design - Augusto Morello.**  
Winner product - Design category.  
*Prodotto vincitore - Categoria Design.*



Please visit website  
*Visita il sito internet*

# BOXER/T

DESIGN BY CASTALDI

Sample code  
*Codice d'esempio*

**D30T/LWW-MB-GR**

For information see catalogue  
*Per informazioni vedi catalogo*  
pag. 226



Photo: Alberto Lagomaggiore



Complesso parrocchiale "San Pio da Pietrelcina"  
Project: Anselmi & Associati



Hospital center - Trigoria Rome

Recognised and awarded for its **aesthetic force** and **technical performances**.

Totally mechanical and corrosion resistant thanks to the use of proper light alloys fully protected and passivated while thermal dissipation is effectively ensured for a long life of the system.

*Riconosciuto e premiato per la **forza estetica** e per le **prestazioni tecniche**.*

*Totale resistenza meccanica a perfetta resistenza alla corrosione grazie agli impieghi di leghe leggere protette e passivate e la dissipazione termica è efficacemente riuscita per assicurarvi la più lunga vita a componenti elettrici del sistema.*

PRODUCTION START  
*INIZIO PRODUZIONE*  
2004

AWARDS  
*PREMI*

**ADI Design Index - Selezione XXI Compasso d'oro.**  
**Design/Preis - Rat für formgebung (german design council)**  
Selected product - Design category. *Prodotto selezionato - Categoria Design.*  
**Design Plus - Light+Building-Frankfurt**  
Winner product - Design category. *Prodotto vincitore - Categoria Design.*  
**Premio Assolombarda**  
**"Arredo urbano al servizio della mobilità sostenibile"**  
Winner product. *Prodotto vincitore.*



# DIABLO

DESIGN BY PIERO CASTIGLIONI

Sample code  
*Codice d'esempio*

**D46/LWW-6D-GR**



Photo: Alberto Lagomaggiore



Seaside walk - San Benedetto del Tronto  
Project: Arch. Farnush Davarpanah Arch. Alessandro Brutti



Diablo is a product that links the best technical performances to a **great reliability**, in order to resist without any damage to lake floods and possible vandalism, maintaining at the same time all the **appeal of its original design** and the friendly possibility to be used as a seat.

*Diablo è un prodotto che unisce alle migliori prestazioni illuminotecniche una **grande affidabilità**, tale da poter resistere indenne a brevi sommersioni e ad eventuali azioni vandaliche, mantenendo nel contempo tutto l'**appeal del design** e l'amichevole possibilità di fungere da seduta.*

Piero Castiglioni



AWARDS  
PREMI

**Design center Stuttgart**

**"Möbel aus italien - Produktion - Technik - Modernität"**

Product selected at show. *Prodotto selezionato alla mostra.*

Curatori: Vittorio Gregotti, Giovanni Klaus-Koenig, François Burkhardt.

**Staatliches Museum für Angewandte kunst - Munchen**

Product requested for the permanent collection of museum.

*Prodotto richiesto per la collezione permanente del museo.*



Please visit website  
Visita il sito internet

# EGEO/N2

DESIGN BY CASTALDI

Sample code  
Codice d'esempio

**D02/WB-LWW-GR**



## HISTORICAL EVOLUTION OF EGEO MODEL, ONE OF THE "CLASSIC" OF THE COMPANY EVOLUZIONE STORICA DI EGEO, UNO DEI "CLASSICI" DELL'AZIENDA

**1960**

Birth of the first version cast in cast iron, designed for the illumination of the Brindisi port quays from where ships sail for the Egeo sea. From here the name of the fixture.

*Nasce la prima versione in fusione di ghisa, destinata ad illuminare le banchine del porto di Brindisi ove salpano le navi in partenza per il mar Egeo, da cui il nome dell'apparecchio.*



**1978**

First redesign of the model, now die-cast in light alloy, suitable for the new high pressure discharge lamps.

*Primo redesign del modello non più in ghisa ma in fusione di lega leggera, adatto alle nuove sorgenti a scarica nel gas ad alta pressione.*



**1993**

Last and present version of the model, featuring a great flexibility and functional application.

*Ultima ed attuale versione dell'apparecchio. Caratterizzata da grande flessibilità e funzionalità applicativa.*



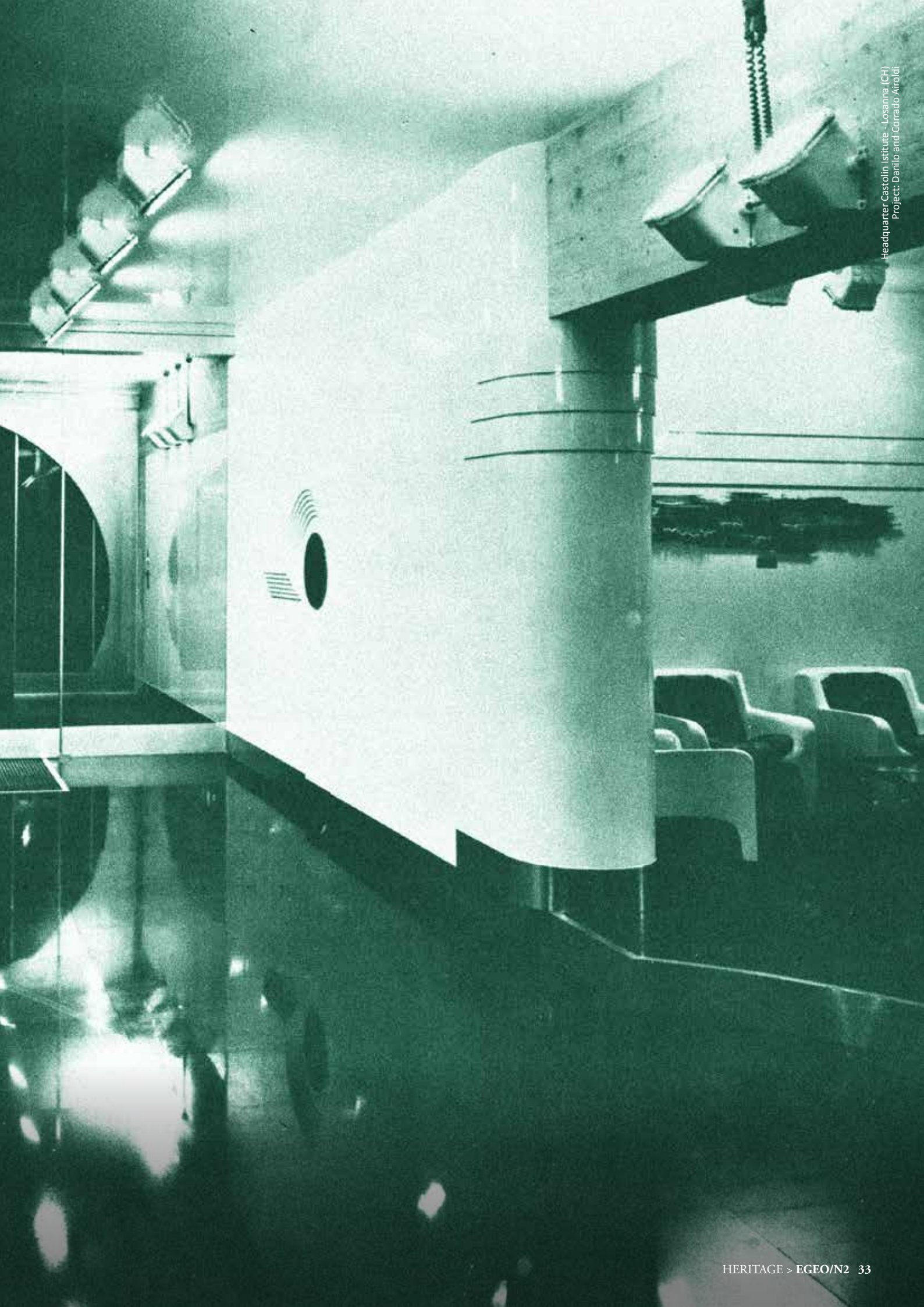

**Countless applications** and years of exemplary operation the rigorous and industrial aesthetics makes Egeo a product transversal to all kind of environment and lets designers to **reinvent continuously the fixture**.

Countless applications, even in extreme environments, tested over the years, state its reliability and durability, coupled to high level performances.

*Innumerevoli applicazioni ed anni di esemplare funzionamento l'estetica rigorosa ed industriale rende Egeo un prodotto trasversale agli ambienti, lasciando al progettista la facoltà di **sempre nuove interpretazioni**.*

*Le infinite applicazioni, in ambienti anche estremi, testate negli anni gli hanno conferito doti proverbiali di affidabilità e durata, che si accompagnano a rendimenti elevati.*

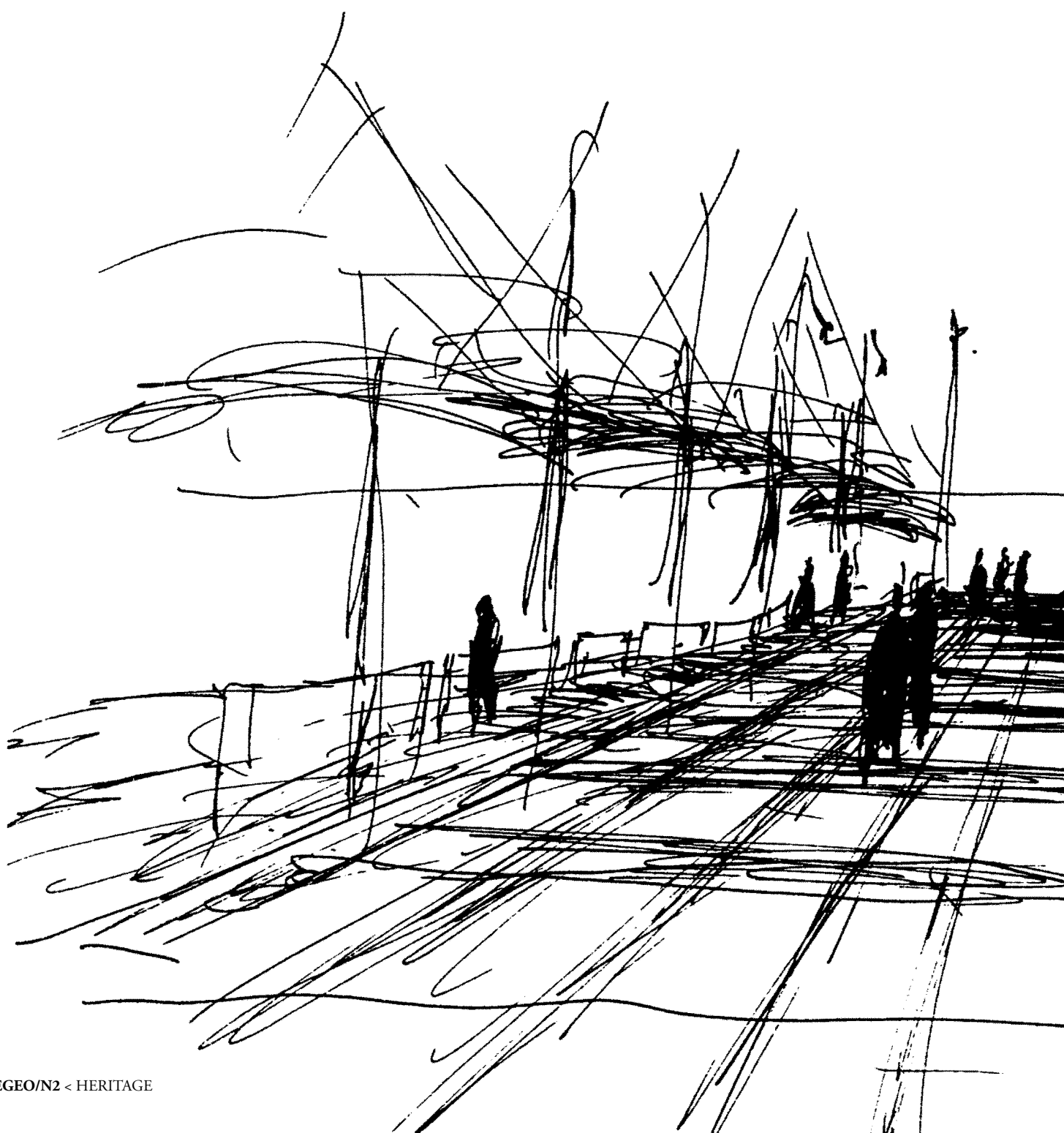



PRODUCTION START  
*INIZIO PRODUZIONE*

1998

AWARDS  
*PREMI*

**Premio Intel Design - Augusto Morello.**  
Winner product - Design category.  
*Prodotto vincitore - Categoria Design.*



# GULLIVER

DESIGN BY CASTALDI

Sample code  
*Codice d'esempio*

**D26/E27-G**



Library - Rosignano Italy  
Project: Studio Una2



For its nature, Gulliver is **great in performances and lilliputian in energy consumption**. Its design allows it to combine generous results, working economy, and flexibility of use. Its aesthetics reflects the company tradition: a **clean, technical and original design**.

*Per la sua natura Gulliver è un **gigante delle prestazioni e un lillipuziano dei consumi**. La sua etica progettuale gli consente di unire prestazioni generose, economia di esercizio e flessibilità d'uso. La sua estetica è in sintonia con la tradizione aziendale: **design asciutto tecnico e originale**.*

PRODUCTION START  
*INIZIO PRODUZIONE*  
1995

AWARDS  
*PREMI*  
15<sup>TH</sup> Biennial of Industrial Design - BIO 15 Ljubljana  
Selected product - *Prodotto selezionato*

# LUCILLA

DESIGN BY CASTALDI

Sample code  
*Codice d'esempio*

**D22/E27-B**



Project: Villa Falconi - La Spezia Italy  
Arch: Progetto Tre Studio Associato





It is conceived for a pleasant and soft lighting of paths, passageways, cafés and open air restaurants, areas close to private houses. Competitive price, low consumption, functional safety, high efficiency, corrosion resistance are the main advantages of this product. Furthermore the scenic effect can be greatly personalised by using simple colour filters.

*Pensato per illuminare in modo gradevole vialetti, passaggi, caffè e ristoranti all'aperto, aree di prossimità di abitazioni private. Limitato costo d'acquisto, economia d'uso, sicurezza funzionale, efficienza luminosa, infrangibilità e totale resistenza alla corrosione sono i vantaggi insiti nel prodotto. L'effetto scenografico può essere personalizzato con l'uso di semplici filtri colore.*

PRODUCTION START  
*INIZIO PRODUZIONE*  
1995



Please visit website  
*Visita il sito internet*

# MINISOSIA

DESIGN BY CASTALDI

Sample code  
*Codice d'esempio*

**D23/E27-AL**



Senigallia municipal historical library and archives.  
Project: Arch. Massimo e Gabriella Carmassi

It's a technical and cultural reference in indoor lighting, either in the different professional application or for domestic use.

Built to last in time, with high quality inalterable raw materials, all models are anyway designed for an immediate and total recycling.

*Riferimento tecnico e culturale nell'illuminazione di interni, sia nelle sfaccettate applicazioni professionali che in ambito domestico. Costruiti per durare nel tempo con materiali di pregio e inalterabili, tutti i modelli sono altresì concepiti per immediata e totale riciclabilità.*

PRODUCTION START  
*INIZIO PRODUZIONE*

1982

HISTORICAL EVOLUTION OF SOSIA MODEL  
*EVOLUZIONE STORICA DI SOSIA*

1978

"Speedo" is an industrial high bay luminaire for high pressure discharge lamps from which "Sosia" will be born marking a deep change in indoor lighting.

*"Speedo" apparecchio industriale per illuminazione di capannoni che utilizza lampade a scarica ad alta pressione, è l'archetipo di Sosia che segnerà un profondo cambiamento nell'illuminazione degli ambienti interni.*



Please visit website  
*Visita il sito internet*

# SOSIA

DESIGN BY CASTALDI

Sample code  
*Codice d'esempio*

**D06K/E27-AL**

For information see catalogue  
*Per informazioni vedi catalogo*  
pag. 202



Photo: Tom Vack



Casa Aversa - Naples Italy  
Project: Arch. Davide Vargas

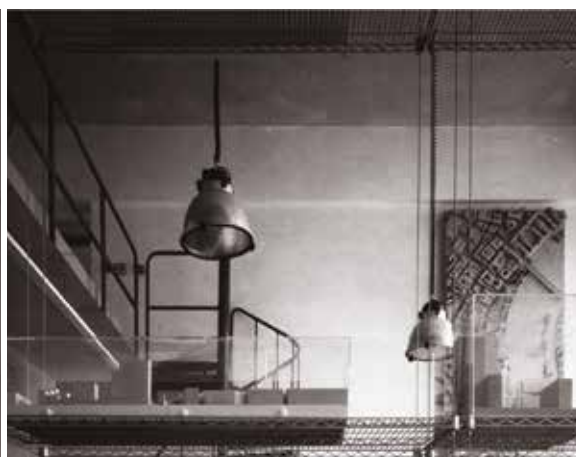



A classic of industrial design, formal and technical fixture still landmark for cleanliness and simplicity of design, technical and operative functionality. It is not by chance that the most prestigious architects and designers recognize in **Sosia** a reference icon in the field of the technical suspensions.

*Un classico del design industriale, impianto formale e tecnico tuttora punto di riferimento per pulizia e semplicità del design, funzionalità tecnica e operativa. Non è un caso se i più prestigiosi architetti e progettisti riconoscono in Sosia l'icona di riferimento nel campo delle sospensioni tecniche.*











Cultural center - Paderno Dugnano (MI) Italy  
Project: Arch. Gae Aulenti - Lighting project: Arch. Piero Castiglioni

PRODUCTION START  
*INIZIO PRODUZIONE*

1980

AWARDS  
*PREMI*

**Design center Stuttgart.**  
"Möbel aus italien - Produktion - Technik - Modernität"  
Product selected at show. *Prodotto selezionato alla mostra.*  
Curatori: Vittorio Gregotti, Giovanni Klaus-Koenig, François Burkhardt.  
**Staatliches Museum für Angewandte kunst - Munchen**  
Product requested for the permanent collection of museum.  
*Prodotto richiesto per la collezione permanente del museo.*



Please visit website  
*Visita il sito internet*

# TORTUGA

DESIGN BY MAURIZIO BERTONI

Sample code  
*Codice d'esempio*

**D03/E27-GR**



Palazzo Fiera - Milan Italy  
Project: Arch. Alfonso Femia with 5+1AA now Atelier(s) Alfonso Femia



The passage of time and the spread of countless imitations increase the value of the original project. Because of its apparent simplicity and technical precision, its flexibility in indoor and outdoor applications, Tortuga has become an icon of design, the certainty of taste, **ethic and quality for those who choose it.**

*Col passare degli anni e il proliferare delle imitazioni aumenta il valore del progetto originale. Per semplicità apparente e precisione tecnica, per la capacità di stare dentro e fuori in rispettosa economia, Tortuga è diventata un' icona del design, una certezza di gusto, etica e qualità per chi la sceglie.*

PRODUCTION START  
*INIZIO PRODUZIONE*  
1996

# VENEZIA

DESIGN BY CASTALDI

Sample code  
*Codice d'esempio*  
**D24/CC-LWW-G**



Biccoca University - Milan Italy

Venezia is the antithesis of the “decorative” glaring lamp posts which deny the balanced and not polluting light control, that should be the first requirement for a quality public lighting. Designed with sober and timeless shapes, venezia, thanks to the use of coloured filters simply assembled in its upper cap, allows also a soft use of colour.

*Venezia è l'antitesi dei “lampioni decorativi” che abbagliano a scapito di quella equilibrata e non inquinante emissione luminosa che dovrebbe essere oggi il primo requisito di una illuminazione pubblica di qualità. Disegnato con linee sobrie e di permanente attualità, il modello venezia, grazie a semplici filtri inseribili nella calotta superiore, introduce anche l'uso moderato del colore.*



**GROUND RECESSED**









# ICE



GROUND  
RECESSED

COMPLETE RANGE  
*GAMMA COMPLETA*



WALL  
RECESSED  
p. 108



WALL SURFACE  
p. 138



CEILING  
RECESSED  
p. 168









#### ENVIRONMENTS

Façades and architectural works, wellness, hallway, industrial areas.

#### PHYSICAL FEATURES

Body: Natural anodised extruded aluminium structure.  
 Die-cast aluminium end caps.  
 Installation kit with harmonic steel springs.  
 Diffuser: Extra clear tempered glass

#### ELECTRICAL FEATURES

Driver: remote, ON-OFF or DALI  
 Voltage: 21-25V-DC  
 Wiring: Remote electrical harness wired for 220-240V-AC  
 50-60Hz, 24V-DC output  
 (accessories to be ordered separately).  
 Integrated through wiring.

#### SOURCES

LED 4000K CRI>80 - 3000K CRI>80  
 MacAdam: Step 3  
 Lifetime: 70.000h L80B10 (Ta=25°C)

#### PERFORMANCE

Up to: 61 lm/W  
 Up to: 945 lm/m

#### CONTESTI

*Facciate e architetture, wellness, spazi d'accesso, industria.*

#### CARATTERISTICHE FISICHE

*Corpo: Struttura in estruso di alluminio anodizzato naturale.  
 Testate in pressofusione di alluminio.  
 Kit di installazione con molle in acciaio armonico.  
 Diffusore: Vetro temperato extra chiaro*

#### CARATTERISTICHE ELETTRICHE

*Driver: Remoto, ON-OFF o DALI  
 Tensione: 21-25V-DC  
 Cablaggio: Elettrico con alimentatori remoti a 220-240V-AC  
 50-60Hz, uscita 24V-DC  
 (accessori da ordinare separatamente).  
 Cablaggio passante integrato.*

#### SORGENTI

LED 4000K CRI>80 - 3000K CRI>80  
 MacAdam: Step 3  
 Durata: 70.000h L80B10 (Ta=25°C)

#### PERFORMANCE

Fino a: 61 lm/W  
 Fino a: 945 lm/m

## EASY AND FAST INSTALLATION

### INSTALLAZIONE FACILE E VELOCE



5 second IP67. Loop connection facility

*Predisposizione per il collegamento loop - IP67 in 5 secondi*

## HOW TO ORDER / COME ORDINARE

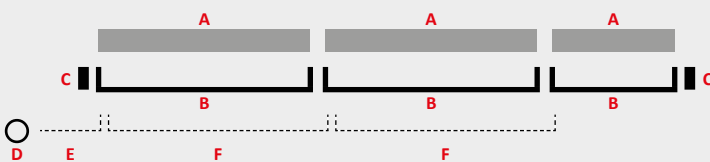

- A** Choose lighting modules / *Scegli i corpi illuminanti*
- B** Match the rough-in housing / *Abbina le casseforme*
- C** Provide end caps (only for frame version)  
*Prevedi le testate di chiusura (solo per casseforme frame)*
- D** Choose drivers / *Scegli i driver*
- E** 1 starting cables for each drivers / *1 starting cable per ogni driver*
- F** Provide looping line (dimension in according to lighting modules lengths)  
*Looping cable (dimensione a seconda delle lunghezze dei prodotti)*

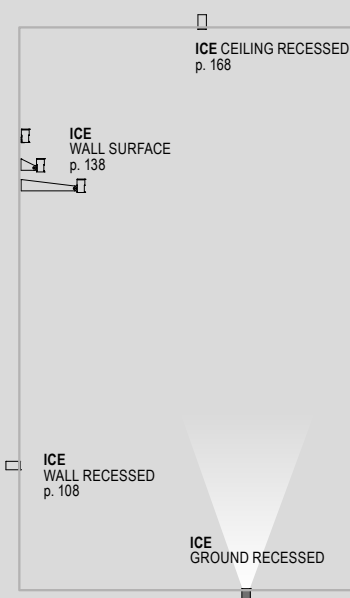

## COMPLETE RANGE GAMMA COMPLETA



# ICE

## SIZE / DIMENSIONI

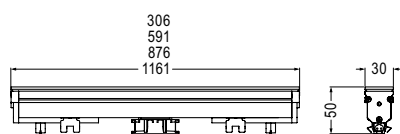

	306 mm	591 mm	876 mm	1161 mm
Total system power	4,5 W	9 W	13,5 W	18 W
Lumen output max	275 lm	548 lm	823 lm	1097 lm

## OPTIC / OTTICHE

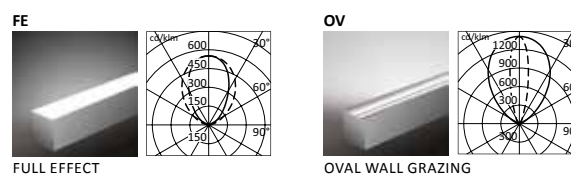

## ROUGH-IN / CASSEFORME



## PRODUCT CODES / CODICI PRODOTTO

# D 6 4 / 3 - 0 3 - 1 L W W - F E

PRODUCT PRODOTTO	SIZE DIMENSIONI	LIGHTING COLORS COLORI DELLA LUCE	OPTICS OTTICHE
D64 = ICE	3-03 = 306 mm 3-06 = 591 mm 3-09 = 876 mm 3-12 = 1161 mm	1 LWN = 4000K CRI80 1 LWW = 3000K CRI80	FE: FULL EFFECT OV: OVAL

To be order separately: Rough-in housing, end caps, starting cable, looping cable, driver.  
 Da ordinare separatamente: casseforme, testate di chiusura, starting cable, looping cable, driver.

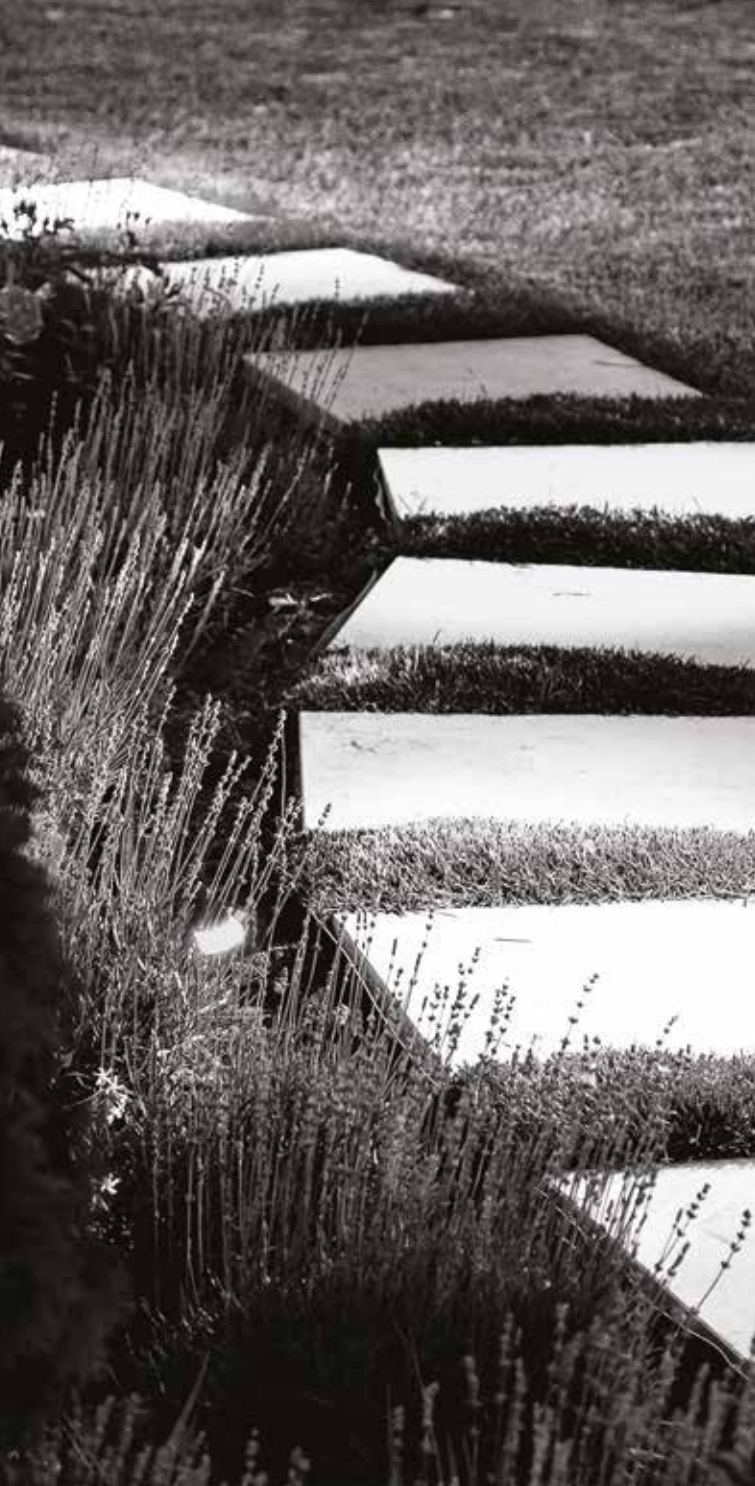

#### ENVIRONMENTS

Urban landscape, façades and architectural works, hallway, residential lighting.

#### PHYSICAL FEATURES

Painting: Polyester powder coating, with a multi-process treatment against corrosion (pass the exposure to over 1500 hours in a saline mist environment).

Body: Corrosion resistant die-cast aluminium body and dome

Diffuser: Polycarbonate anti UV

Static load resistance: 2000 Kg

#### ELECTRICAL FEATURES

Driver: Integral ON-OFF or DALI

Voltage: 220-240V

Frequency: 50-60Hz

Wiring: Pre-wired and tested with resin sealed watertight

#### SOURCES

LED 4000K CRI>80 - 3000K CRI>80

MacAdam: Step 3

Lifetime: 60.000h L90B10 (Ta=25°C) P01-P1

50.000h L80B10 (Ta=25°C) P2

#### PERFORMANCE

Up to: 49 lm/W

#### CONTESTI

Aree urbane/verdi, facciate e architetture, spazi d'accesso, illuminazione residenziale.

#### CARATTERISTICHE FISICHE

Verniciatura: Verniciatura a polveri poliesteri, previo pluritrattamenti contro la corrosione (supera il test di 1500 ore in nebbia salina).

Corpo: Corpo e calotta in alluminio pressofuso, resistente alla corrosione.

Diffusore: Policarbonato anti UV

Resistenza al carico statico: 2000 Kg

#### CARATTERISTICHE ELETTRICHE

Driver: Integrato ON-OFF o DALI

Tensione: 220-240V

Frequenza: 50-60Hz

Cablaggio: Completo di spezzone di cavo collaudato a tenuta

#### SORGENTI

LED 4000K CRI>80 - 3000K CRI>80

MacAdam: Step 3

Durata: 60.000h L90B10 (Ta=25°C) P01-P1

50.000h L80B10 (Ta=25°C) P2

#### PERFORMANCE

Fino a: 49 lm/W

## BEAM ADJUSTMENT

### REGOLAZIONE DEL FASCIO



The light beam can have 3 inclinations:  
0° (default value) - 22° - 45°  
Il fascio di luce può avere 3 inclinazioni:  
0° (default) - 22° - 45°

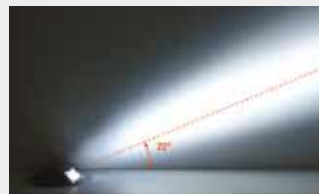

## COORDINATED FAMILIES FAMIGLIE COORDINATE



PASSO F  
p. 66

PASSO B  
p. 66

INDICO

IRIDE  
p. 60





# INDICO

## SIZE / DIMENSIONI

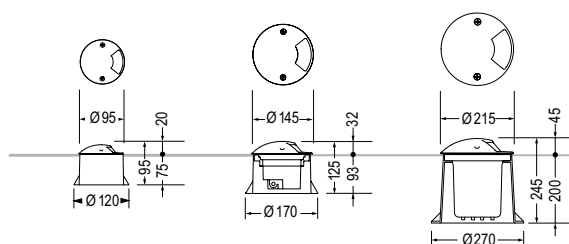

	P01	P1	P2
Size	Ø95 mm	Ø145 mm	Ø215 mm
Total system power	2W	4,4W	10W
Lumen output max	86 lm	164 lm	491 lm

## OPTIC / OTTICHE

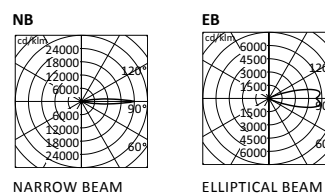

NARROW BEAM

ELLIPTICAL BEAM

## PRODUCT CODES / CODICI PRODOTTO

# D 4 4 K / P 1 - L W N N B - A L

PRODUCT PRODOTTO	SIZE DIMENSIONI	LIGHTING COLORS COLORI DELLA LUCE	OPTICS OTTICHE	CONTROLS CONTROLLI	FINISH FINITURE
D44K = INDICO ground recessed	P01 = Ø 95 mm (2W) P1 = Ø 145 mm (4,4W) P2 = Ø 215 mm (10W)	LWN = 4000K CRI>80 LWW = 3000K CRI>80	NB: NARROW BEAM EB: ELLIPTICAL BEAM	Standard ON-OFF add/aggiungere DD* = DALI	AL = ALUMINIUM GREY GR = GRAPHITE

\* Only for size P2 / Solo per dimensione P2  
 Rough-in housing included / Casseforme incluse



#### ENVIRONMENTS

Urban landscape, façades and architectural works, hallway, residential lighting.

#### PHYSICAL FEATURES

Painting: Polyester powder coating, with a multi-process treatment against corrosion (pass the exposure to over 1500 hours in a saline mist environment).

Body: Corrosion resistant die-cast aluminium body and dome  
Diffuser: Polycarbonate anti UV  
Static load resistance: 2000 Kg

#### ELECTRICAL FEATURES

Driver: Integral ON-OFF or DALI

Voltage: 220-240V

Frequency: 50-60Hz

Wiring: Pre-wired and tested with resin sealed watertight

#### SOURCES

LED 4000K CRI>80 - 3000K CRI>80

MacAdam: Step 3

Lifetime: 60.000h L90B10 (Ta=25°C)

#### PERFORMANCE

Up to: 25 lm/W

#### CONTESTI

Aree urbane/verdi, facciate e architetture, spazi d'accesso, illuminazione residenziale.

#### CARATTERISTICHE FISICHE

Verniciatura: a polveri poliesteri, previo pluritrattamenti contro la corrosione (supera il test di 1500 ore in nebbia salina).

Corpo: Telaio in acciaio inox AISI 316 sabbiato

Diffusore: Policarbonato anti UV

Resistenza al carico statico: 2000 Kg

#### CARATTERISTICHE ELETTRICHE

Driver: Integrato ON-OFF o DALI

Tensione: 220-240V

Frequenza: 50-60Hz

Cablaggio: Completo di spezzone di cavo collaudato a tenuta

#### SORGENTI

LED 4000K CRI>80 - 3000K CRI>80

MacAdam: Step 3

Durata: 60.000h L90B10 (Ta=25°C)

#### PERFORMANCE

Fino a: 25 lm/W

#### BEAMS / FASCI

LWN/WW



LW4/WW4



#### COORDINATED FAMILIES FAMIGLIE COORDINATE



PASSO F  
p. 66



PASSO B  
p. 66



INDACO  
p. 58



IRIDE



#### DRIVEOVER / CARRABILE



IRIDE models are driveover up to 2000 kg.

I modelli della serie IRIDE sono carrabili fino a 2000 kg.



# IRIDE

## SIZE / DIMENSIONI

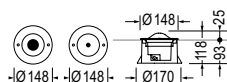

Size	<b>Ø 148 mm</b>
Total system power	3W
Lumen output max	74 lm

## OPTIC / OTTICHE

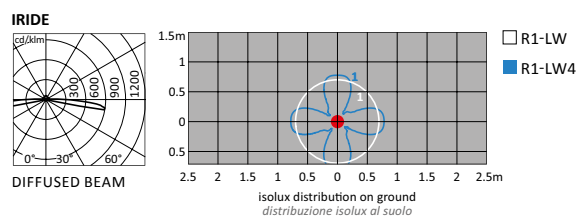

## PRODUCT CODES / CODICI PRODOTTO

# D 4 4 K / R 1 - L W N

PRODUCT PRODOTTO	EMISSION EMISSIONI	SIZE DIMENSIONI	LIGHTING COLORS COLORI DELLA LUCE
<b>D44K</b> = IRIDE ground recessed	<b>R</b> = 360° emission	<b>1</b> = Ø 148mm (3W)	<b>LWN</b> = 4000K CRI>80 Diffused <b>LWW</b> = 3000K CRI>80 Diffused <b>LWN4</b> = 4000K CRI>80 4 Beams <b>LWW4</b> = 3000K CRI>80 4 Beams

Rough-in housing included / Casseforme incluse

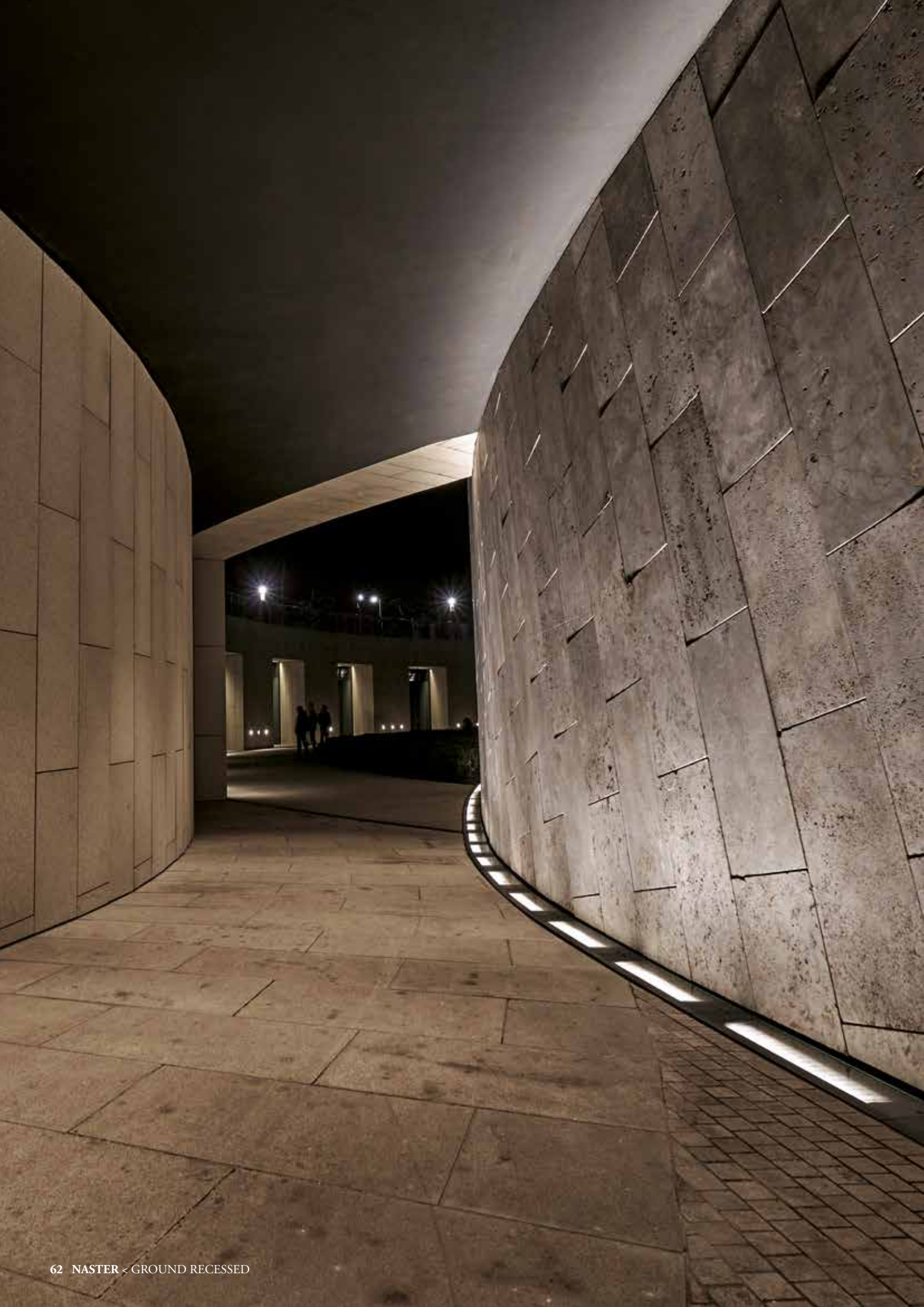





# NASTER

DESIGN BY EMANUELA PULVIRENTI



GROUND  
RECESSED

COMPLETE RANGE  
*GAMMA COMPLETA*



BOLLARD  
p. 92

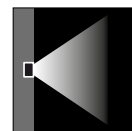

WALL  
RECESSED  
p. 110



CEILING  
RECESSED  
p. 170



#### ENVIRONMENTS

Façades and architectural works, hallway, industrial areas, railway areas, subway areas.

#### PHYSICAL FEATURES

Painting: Polyester powder coating, with a multi-process treatment against corrosion (pass the exposure to over 1500 hours in a saline mist environment).

Body: Corrosion resistant extruded aluminium body.  
Corrosion resistant die-cast aluminium end caps.

Diffuser: Extra clear tempered glass  
Static load resistance: 2000 Kg

#### ELECTRICAL FEATURES

Driver: Integral, ON-OFF or DALI

Voltage: 220-240V

Frequency: 50-60Hz

Wiring: Internal looping facility with two rubber cable resin sealed.

#### SOURCES

LED 4000K CRI>80 - 3000K CRI>80 - RGBW

MacAdam: Step 3

Lifetime: 50.000h L80B50 (Ta=25°C)

#### PERFORMANCE

Up to: 83 lm/W

#### CONTESTI

Facciate e architetture, spazi d'accesso, industria, aree ferroviarie, aree metropolitane.

#### CARATTERISTICHE FISICHE

Verniciatura: a polveri poliesteri, previo pluritrattamenti contro la corrosione (supera il test di 1500 ore in nebbia salina)

Corpo: in alluminio estruso, resistente alla corrosione.

Testate di chiusura pressofuse in alluminio resistente alla corrosione.

Diffusore: vetro temperato extra chiaro

Resistenza al carico statico: 2000 Kg

#### CARATTERISTICHE ELETTRICHE

Driver: Integrato, ON-OFF o DALI

Tensione: 220-240V

Frequenza: 50-60Hz

Cablaggio: Derivazione interna già predisposta con due cavi in uscita resinati.

#### SORGENTI

LED 4000K CRI>80 - 3000K CRI>80 - RGBW

MacAdam: Step 3

Durata: 50.000h L80B50 (Ta=25°C)

#### PERFORMANCE

Fino a: 83 lm/W

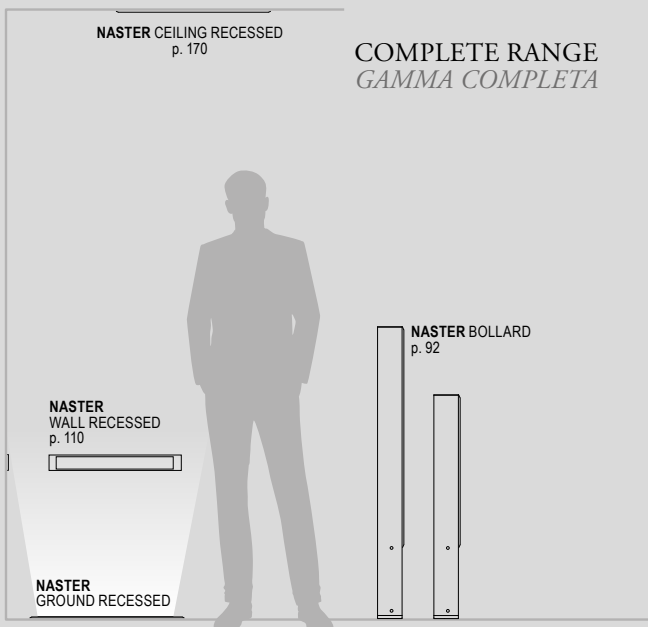

#### ACCESSORIES / ACCESSORI



Honeycomb louvre for Wall Grazing optic.  
Honeycomb antiabbagliamento per ottica Wall Grazing.

Accessories factory assembled.

Please order with products.

Accessori montati in fabbrica. Si prega di ordinarli in contemporanea con i prodotti.



# MASTER

DESIGN BY EMANUELA PULVIRENTI

## SIZE / DIMENSIONI

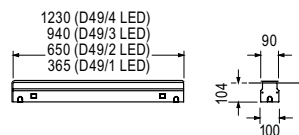

	365 mm	650 mm	650 mm	940 mm	940 mm	1230 mm	1230 mm
Total system power	12 W	20 W	30 W	28 W	44 W	37 W	57 W
Lumen output max	997 lm	1661 lm	933 lm	2326 lm	1400 lm	3073 lm	1865 lm

## OPTIC / OTTICHE

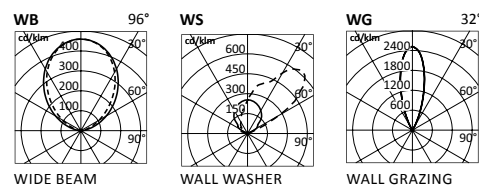

## PRODUCT CODES / CODICI PRODOTTO

**D 4 9 / 1 - L W N - W S - A L**

PRODUCT PRODOTTO	SIZE DIMENSIONI	LIGHTING COLORS COLORI DELLA LUCE	OPTICS OTTICHE	CONTROLS CONTROLLI	FINISH FINITURE
D49 = MASTER	1 = L: 365mm - 12W 2 = L: 650mm - 20W 3 = L: 940mm - 28W 4 = L: 1230mm - 37W	LWN = 4000K CRI>80 LWW = 3000K CRI>80 RGBW*	WB: WIDE BEAM WS: WALL WASHER WG: WALL GRAZING	Standard ON-OFF add/aggiungere DD = DALI	AL = ALUMINIUM GREY GR = GRAPHITE

\*Only for size 2-3-4 and only for WG optic/ Solo per dimensione 2-3-4 e solo per ottica WG  
To be order separately: rough-in housing / Da ordinare separatamente: casseforme.



#### ENVIRONMENTS

Urban landscape, façades and architectural works, hallway, residential lighting.

#### PHYSICAL FEATURES

Painting: Polyester powder coating, with a multi-process treatment against corrosion (pass the exposure to over 1500 hours in a saline mist environment).

Body: Corrosion resistant die-cast aluminium body and dome

Diffuser: Polycarbonate anti UV

Static load resistance: 2000 Kg

#### ELECTRICAL FEATURES

Driver: Integral ON-OFF or DALI

Voltage: 220-240V

Frequency: 50-60Hz

Wiring: Pre-wired and tested with resin sealed watertight

#### SOURCES

LED 4000K CRI>80 - 3000K CRI>80

MacAdam: Step 3

Lifetime: 60.000h L90B10 (Ta=25°C) 01-1  
50.000h L80B10 (Ta=25°C) 2

#### PERFORMANCE

Up to: 36 lm/W

#### CONTESTI

Aree urbane/verdi, facciate e architetture, spazi d'accesso, illuminazione residenziale.

#### CARATTERISTICHE FISICHE

Verniciatura: a polveri poliesteri, previo pluritrattamenti contro la corrosione

(supera il test di 1500 ore in nebbia salina).

Corpo e calotta in alluminio pressofuso, resistente alla corrosione.

Diffusore: Policarbonato anti UV

Resistenza al carico statico: 2000 Kg

#### CARATTERISTICHE ELETTRICHE

Driver: Integrato ON-OFF o DALI

Tensione: 220-240V

Frequenza: 50-60Hz

Cablaggio: Completo di spezzone di cavo collaudato a tenuta

#### SORGENTI

LED 4000K CRI>80 - 3000K CRI>80

MacAdam: Step 3

Durata: 60.000h L90B10 (Ta=25°C) 01-1  
50.000h L80B10 (Ta=25°C) 2

#### PERFORMANCE

Fino a: 36 lm/W

#### BEAMS / FASCI

##### PASSO B



##### PASSO F



#### COORDINATED FAMILIES FAMIGLIE COORDINATE



##### PASSO F



##### PASSO B



##### INDICO p. 58



##### IRIDE p. 60



#### DRIVEOVER / CARRABILE



PASSO models are driveover up to 2000kg.

I modelli della serie PASSO sono carrabili fino a 2000kg.



# PASSO

## SIZE / DIMENSIONI

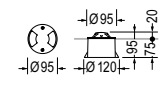
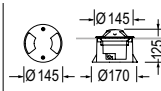
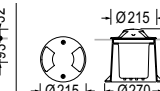
			
	<b>PASSO B01</b>	<b>PASSO B1</b>	<b>PASSO B2</b>
Size	<b>Ø 95 mm</b>	<b>Ø 145 mm</b>	<b>Ø 215 mm</b>
Total system power	2 W	3 W	5 W
Lumen output max	38 lm	42 lm	50 lm

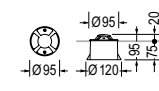
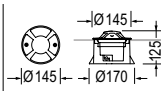
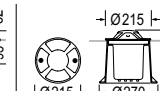
			
	<b>PASSO F01</b>	<b>PASSO F1</b>	<b>PASSO F2</b>
Size	<b>Ø 95 mm</b>	<b>Ø 145 mm</b>	<b>Ø 215 mm</b>
Total system power	2 W	6 W	10 W
Lumen output max	73 lm	79 lm	109 lm

## OPTIC / OTTICHE

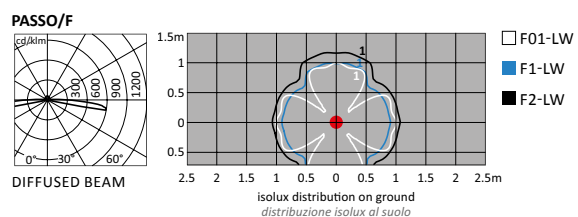
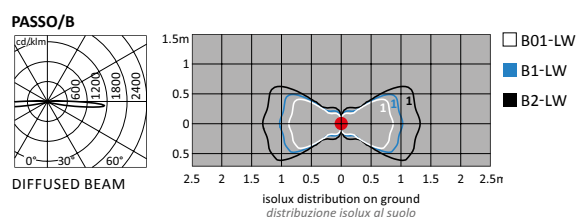

## PRODUCT CODES / CODICI PRODOTTO

# D 4 4 K / F 1 - L W N - A L

PRODUCT PRODOTTO	EMISSION EMISSIONI	SIZE DIMENSIONI	LIGHTING COLORS COLORI DELLA LUCE	CONTROLS CONTROLLI	FINISH FINITURE
<b>D44K</b> = PASSO ground recessed	<b>B</b> = 2 beams/fasci <b>F</b> = 4 beams/fasci	<b>01</b> = Ø 95mm (2W) <b>1</b> = Ø 145mm (6W) <b>2</b> = Ø 215mm (10W)	<b>LWN</b> = 4000K CRI>80 <b>LWW</b> = 3000K CRI>80	Standard ON-OFF add/aggiungere <b>DD*</b> = DALI	<b>AL</b> = ALUMINIUM GREY <b>GR</b> = GRAPHITE

\*Only for size 2 / Solo per dimensione 2  
Rough-in housing included / Casseforme incluse





# TELLUX SMALL



GROUND  
RECESSED

COMPLETE RANGE  
*GAMMA COMPLETA*

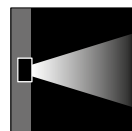

WALL  
RECESSED  
p. 112



CEILING  
RECESSED  
p. 176



TELLUX SMALL 00	IP68 -1m	IK10	CE	IS
TELLUX SMALL 01	IP66 IP67	IK08	CE	IS
TELLUX SMALL 1	IP66 IP67	IK10	CE	IS

#### ENVIRONMENTS

Urban landscape, façades and architectural works, hallway, residential lighting.

#### PHYSICAL FEATURES

Body: Corrosion resistant anodized aluminium body.  
 High impact resistant composite technopolymer housing box.  
 AISI 316 stainless steel frame sandblasted.  
 Diffuser: Extra clear tempered glass  
 Static load resistance: 2000 Kg 01-1  
 Screws: AISI 304 stainless steel screws  
 Seals: Silicone Rubber

#### ELECTRICAL FEATURES

Driver: Integral ON-OFF  
 Remote ON-OFF or DALI only for 00  
 Voltage: 220-240V  
 12-24V-DC only for 00  
 Frequency: 50-60Hz  
 Wiring: Pre-wired and tested with resin sealed watertight

#### SOURCES

LED 4000K CRI>80 - 3000K CRI>80  
 MacAdam: Step 3  
 Lifetime: 60.000h L90B10 (Ta=25°C)

#### PERFORMANCE

Up to: 98 lm/W

#### CONTESTI

Aree urbane / verdi, facciate e architetture, spazi d'accesso, illuminazione residenziale.

#### CARATTERISTICHE FISICHE

Corpo: in alluminio anodizzato, resistente alla corrosione.  
 Cassaforma in tecnopolimero composito ad alta resistenza.  
 Telaio in acciaio inox AISI 316 sabbato.  
 Diffusore: Vetro temperato extra chiaro  
 Resistenza al carico statico: 2000 Kg 01-1  
 Viteria: Viteria inox AISI 304  
 Guarnizioni: Gomma ai siliconi

#### CARATTERISTICHE ELETTRICHE

Driver: Integrato ON-OFF  
 Remoto o DALI solo per 00  
 Tensione: 220-240V  
 12-24V-DC solo per 00  
 Frequenza: 50-60Hz  
 Cablaggio: Completo di spezzone di cavo collaudato a tenuta

#### SORGENTI

LED 4000K CRI>80 - 3000K CRI>80  
 MacAdam: Step 3  
 Durata: 60.000h L90B10 (Ta=25°C)

#### PERFORMANCE

Fino a: 98 lm/W

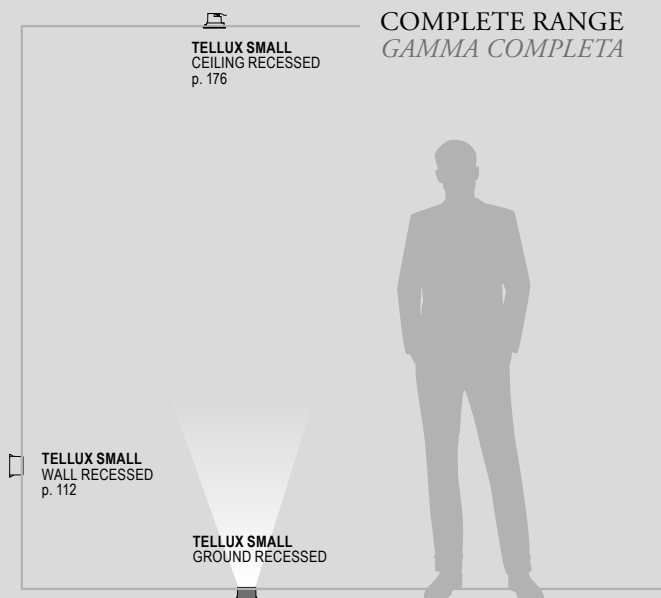





# TELLUX SMALL

## SIZE / DIMENSIONI

	<b>T00</b>	<b>Q00</b>	<b>T01</b>	<b>Q01</b>	<b>T1</b>	<b>Q1</b>	<b>T1 COB</b>	<b>Q1 COB</b>
Size	Ø45 mm	45x45 mm	Ø95 mm	95x95 mm	Ø148 mm	148x148 mm	Ø148 mm	148x148 mm
Total system power	1 W		1 W		4 W		6 W	
Lumen output max	77 lm		98 lm		320 lm		568 lm	

## OPTIC / OTTICHE

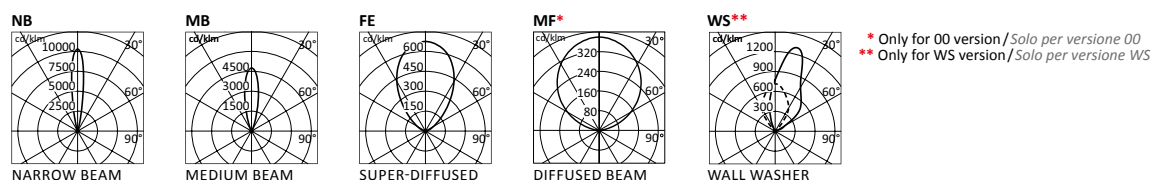

## PRODUCT CODES / CODICI PRODOTTO

**D 4 4 K / T 0 1 - 1 L W N - M B**

PRODUCT PRODOTTO	CLASS CLASSE	SHAPE FORMA	SIZE DIMENSIONI	VERSIONS VERISONI	LIGHTING COLORS COLORI DELLA LUCE	BEAMS FASCI
<b>D44</b> = TELLUX SMALL ground recessed	<b>K*</b> = Class I	<b>T</b> = Round <b>Q</b> = Square	<b>00</b> = 45 mm (1W) <b>01</b> = 95 mm (1W)	= T00 1 = T01	<b>LWN</b> = 4000K CRI>80 <b>LWW</b> = 3000K CRI>80	<b>NB</b> = NARROW BEAM <b>MB*</b> = MEDIUM BEAM <b>MF**</b> = DIFFUSED <b>FE*</b> = FULL EFFECT

\*Only for 01 versions/ Solo per versioni 01

\*\*Only for 00 version/ Solo per versione 00

Rough-in housing included / Casseforme incluse

**D 4 4 K / T 1 - 3 L W N - M B**

PRODUCT PRODOTTO	CLASS CLASSE	SHAPE FORMA	SIZE DIMENSIONI	VERSIONS VERISONI	LIGHTING COLORS COLORI DELLA LUCE	BEAMS FASCI
<b>D44</b> = TELLUX SMALL ground recessed	<b>K</b> = Class I	<b>T</b> = Round <b>Q</b> = Square	1 = 148 mm	1 = COB 6W 3 = POWER LED 4,4W	<b>LWN</b> = 4000K CRI>80 <b>LWW</b> = 3000K CRI>80	<b>NB</b> = NARROW BEAM <b>MB</b> = MEDIUM BEAM <b>FE</b> = FULL EFFECT <b>WS*</b> = WALL WASHER

\*Only for COB version/ Solo per versione COB

Rough-in housing included / Casseforme incluse





# TELLUX



GROUND  
RECESSED

COMPLETE RANGE  
*GAMMA COMPLETA*



CEILING  
RECESSED  
p. 178



### ENVIRONMENTS

Urban landscape, façades and architectural works, hallway, residential lighting.

### PHYSICAL FEATURES

Body: corrosion resistant die-cast aluminium body.  
 High impact resistant composite technopolymer housing box.  
 AISI 316 stainless steel frame sandblasted.  
 Diffuser: Extra clear tempered glass  
 Static load resistance: 3500 Kg  
 Screws: AISI 304 stainless steel screws  
 Seals: Silicone Rubber

### ELECTRICAL FEATURES

Driver: Integral ON-OFF or DALI  
 Voltage: 220-240V  
 Frequency: 50-60Hz  
 Wiring: Pre-wired and tested with resin sealed watertight

### SOURCES

LED 4000K CRI>80 - 3000K CRI>80  
 MacAdam: Step 3  
 Lifetime: 50.000h L80B10 (Ta=25°C)

### PERFORMANCE

Up to: 108lm/W

### CONTESTI

Aree urbane / verdi, facciate e architetture, spazi d'accesso, illuminazione residenziale.

### CARATTERISTICHE FISICHE

Corpo: in alluminio pressofuso, resistente alla corrosione.  
 Cassaforma in tecnopolimero composito ad alta resistenza.  
 Telaio in acciaio inox AISI 316 sabbiato.  
 Diffusore: Vetro temperato extra chiaro  
 Resistenza al carico statico: 3500 Kg  
 Viteria: Viteria inox AISI 304  
 Guarnizioni: Gomma ai siliconi

### CARATTERISTICHE ELETTRICHE

Driver: Integrato ON-OFF o DALI  
 Tensione: 220-240V  
 Frequenza: 50-60Hz  
 Cablaggio: Completo di spezzone di cavo collaudato a tenuta

### SORGENTI

LED 4000K CRI>80 - 3000K CRI>80  
 MacAdam: Step 3  
 Durata: 50.000h L80B10 (Ta=25°C)

### PERFORMANCE

Fino a: 108lm/W

## 2 PRODUCTS IN 1 / 2 PRODOTTI IN 1

### OPTICS



### FULL EFFECT



**Optics** (available in NB-SB MB-EB-WB-WS beams) for power lighting.  
**FULL EFFECT** disc in Plexiglass edgelifighting for soft lighting and step light.

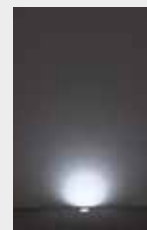

**Switch between Optics or FULL EFFECT beam via DALI controller.**  
*Optico* (disponibile in NB-SB-MB-EB-WB-WS) per illuminazione di potenza.  
*Disco FULL EFFECT* in Plexiglass edgelifighting per illuminazione soft e segnapasso.  
**Cambia il fascio Optico o FULL EFFECT utilizzando un controller DALI.**

## OPTIONAL ACCESSORIES

### ACCESSORI OPZIONALI



Optional honeycomb anti-glare louver (already included only for NB optic).  
 Griglia honeycomb antiabbagliamento opzionale (già inclusa solo per ottica NB).

Accessories factory assembled. Please order with products.  
 Accessori montati in fabbrica. Si prega di ordinarli in contemporanea con i prodotti.



TELLUX  
CEILING RECESSED  
p. 178

## COMPLETE RANGE GAMMA COMPLETA



TELLUX  
GROUND RECESSED

TELLUX COMPACT  
GROUND RECESSED  
p. 76





**VOLVENDO**  
ORBITAL AIMING  
ORIENTAMENTO ORBITALE



DUAL EFFECT AVAILABLE

**COB**  
FIXED OPTIC  
OTTICA FISSA



DUAL EFFECT AVAILABLE



# TELLUX

## SIZE / DIMENSIONI

	<b>T2 VOLVENDO</b>	<b>T2 COB</b>	<b>Q2 VOLVENDO</b>
Size	Ø 215 mm		225 x 225 mm
Total system power max	13,5 W	28 W	10,6 W
Lumen output max	878 lm	3025 lm	831 lm

## OPTIC / OTTICHE

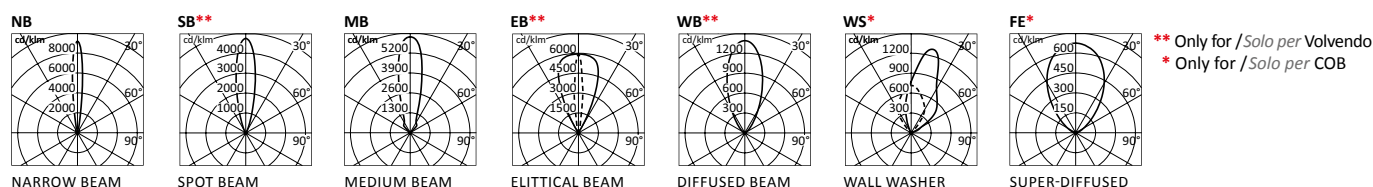

## PRODUCT CODES / CODICI PRODOTTO

**D 4 4 K / T 2 H P - 1 L W N - M B D - D D**

PRODUCT PRODOTTO	COB POWER POTENZA COB	LED	LIGHTING COLORS COLORI DELLA LUCE	BEAMS FASCI	DUAL EFFECT	CONTROLS CONTROLLI
<b>D44K/T2</b> = TELLUX /T2 ground recessed	Standard 13W <b>HP*</b> = High power 28W	1 = COB version fixed optic 5V = VOLVENDO POWER LED adjustable ±15°	<b>LWN</b> = 4000K CRI>80 <b>LWW</b> = 3000K CRI>80	<b>NB</b> = NARROW BEAM <b>SB**</b> = SPOT BEAM <b>MB</b> = MEDIUM BEAM <b>EB**</b> = ELLIPTICAL BEAM <b>WB**</b> = WIDE BEAM <b>WS*</b> = WALL WASHER <b>FE*</b> = SUPER DIFFUSED	<b>STANDARD</b> = CLEAR GLASS <b>D</b> = DUAL EFFECT VERSION  <b>WB</b> and <b>FE</b> not available in Dual Effect	Standard ON-OFF add/aggiungere <b>DD</b> = DALI

\*Only for COB versions/ Solo per versioni COB

\*\*Only for VOLVENDO versions/ Solo per versioni VOLVENDO

Rough-in housing included / Casseforme incluse

**D 4 4 K / Q 2 - 5 V L W N - M B**

PRODUCT PRODOTTO	LED	LIGHTING COLORS COLORI DELLA LUCE	BEAMS FASCI	CONTROLS CONTROLLI
<b>D44K/Q2</b> = TELLUX /Q2 ground recessed	5V = VOLVENDO POWER LED 10.6W	<b>LWN</b> = 4000K CRI>80 <b>LWW</b> = 3000K CRI>80	<b>NB</b> = NARROW BEAM <b>SB</b> = SPOT BEAM <b>MB</b> = MEDIUM BEAM <b>EB</b> = ELLIPTICAL BEAM <b>WB</b> = WIDE BEAM	Standard ON-OFF add/aggiungere <b>DD</b> = DALI

Rough-in housing included / Casseforme incluse



#### ENVIRONMENTS

Urban landscape, façades and architectural works, hallway, residential lighting.

#### PHYSICAL FEATURES

Body: corrosion resistant die-cast aluminium body.  
 High impact resistant composite technopolymer housing box.  
 AISI 316 stainless steel frame sandblasted.  
 Diffuser: Extra clear tempered glass  
 Static load resistance: 3500 Kg  
 Screws: AISI 304 stainless steel screws  
 Seals: Silicone Rubber

#### ELECTRICAL FEATURES

Driver: Integral ON-OFF or DALI  
 Voltage: 220-240V  
 Frequency: 50-60Hz  
 Wiring: Pre-wired and tested with resin sealed watertight

#### SOURCES

LED 4000K CRI>80 - 3000K CRI>80  
 MacAdam: Step 3  
 Lifetime: 50.000h L80B10 (Ta=25°C)

#### PERFORMANCE

Up to: 101 lm/W

#### CONTESTI

Aree urbane / verdi, facciate e architetture, spazi d'accesso, illuminazione residenziale.

#### CARATTERISTICHE FISICHE

Corpo: in alluminio pressofuso, resistente alla corrosione.  
 Cassaforma in tecnopolimero composito ad alta resistenza.  
 Telaio in acciaio inox AISI 316 sabbiato.  
 Diffusore: Vetro temperato extra chiaro  
 Resistenza al carico statico: 3500 Kg  
 Viteria: Viteria inox AISI 304.  
 Guarnizioni: Gomma ai siliconi.

#### CARATTERISTICHE ELETTRICHE

Driver: Integrato ON-OFF o DALI  
 Tensione: 220-240V  
 Frequenza: 50-60Hz  
 Cablaggio: Completo di spezzone di cavo collaudato a tenuta

#### SORGENTI

LED 4000K CRI>80 - 3000K CRI>80  
 MacAdam: Step 3  
 Durata: 50.000h L80B10 (Ta=25°C)

#### PERFORMANCE

Fino a: 101 lm/W

## 2 PRODUCTS IN 1 / 2 PRODOTTI IN 1

#### OPTICS



#### FULL EFFECT



**Optics** (available in NB-SB MB-WS beams) for power lighting.  
**FULL EFFECT disc** in Plexiglass edgelighting for soft lighting and step light.

**Switch between Optics or FULL EFFECT beam via DALI controller.**

*Optico (disponibile in NB-SB-MB-WS) per illuminazione di potenza.*  
*Disco FULL EFFECT in Plexiglass edgelighting per illuminazione soft e segnapasso.*  
**Cambia il fascio Optico o FULL EFFECT utilizzando un controller DALI.**

## OPTIONAL ACCESSORIES

### ACCESSORI OPZIONALI

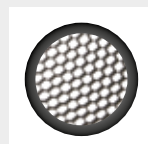

Optional honeycomb anti-glare louver (already included only for NB optic).  
 Griglia honeycomb antiabbagliamento opzionale (già inclusa solo per ottica NB)

Accessories factory assembled.  
 Please order with products.  
 Accessori montati in fabbrica. Si prega di ordinarli in contemporanea con i prodotti.



TELLUX  
 CEILING RECESSED  
 p. 178

## COMPLETE RANGE GAMMA COMPLETA

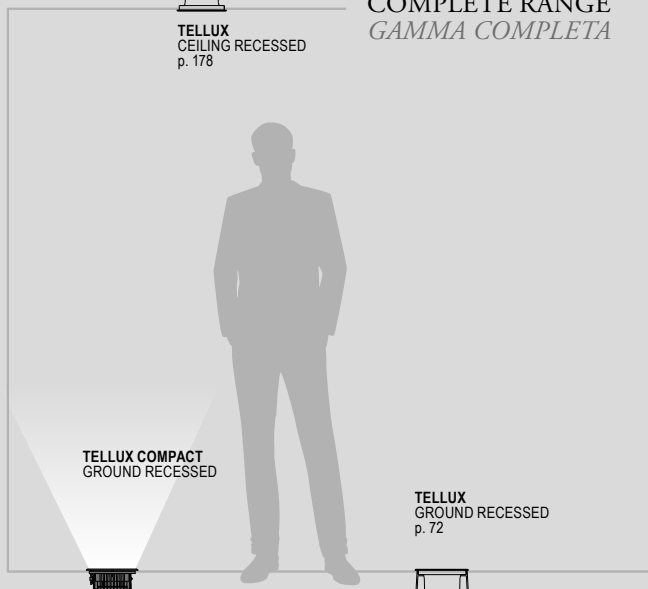

TELLUX COMPACT  
 GROUND RECESSED

TELLUX  
 GROUND RECESSED  
 p. 72



# TELLUX COMPACT

## SIZE / DIMENSIONI

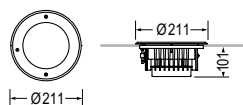

T2 COMPACT COB | T2 COMPACT Easy Tilt

Size	Ø211 mm	
Total system power max	20 W	13,5 W
Lumen output max	2020 lm	1020 lm

## OPTIC / OTTICHE

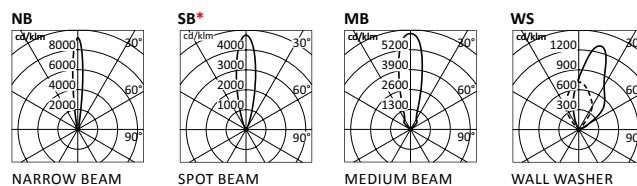

\* Only for / Solo per Easy Tilt

## VERSION / VERSIONE EASY TILT



Adjust beam from outside without opening the products. Easy and Fast.  
Orienta il fascio dall'esterno senza aprire il prodotto.  
Facile e veloce!

## PRODUCT CODES / CODICI PRODOTTO

**D 4 4 K / T 2 C - 8 3 F X - N B D - D D**

PRODUCT PRODOTTO	BODY CORPO	LIGHTING COLORS COLORI DELLA LUCE	VERSION VERSIONI	BEAMS FASCI	DUAL EFFECT	CONTROLS CONTROLLI
D44K/T2 = TELLUX / T2 ground recessed	C = COMPACT	83 = 3000K CRI>80 84 = 4000K CRI>80	FX = COB FIXED ET = EASY TILT	NB = NARROW BEAM SB* = SPOT BEAM MB = MEDIUM BEAM WS = WALL WASHER	STANDARD = CLEAR GLASS D = DUAL EFFECT VERSION	Standard ON-OFF add/aggiungere DD = DALI

\*Only for/ Solo per versioni Easy Tilt Rough-in housing included/Casseforme incluse







# TELLUX LARGE



GROUND  
RECESSED

COMPLETE RANGE  
*GAMMA COMPLETA*



CEILING  
RECESSED  
p. 180



#### ENVIRONMENTS

Urban landscape, façades and architectural works, hallway, residential lighting.

#### PHYSICAL FEATURES

Body: corrosion resistant die-cast aluminium body.  
 High impact resistant composite technopolymer housing box.  
 AISI 316 stainless steel frame sandblasted.  
 Diffuser: Extra clear tempered glass  
 Static load resistance: 3500 Kg  
 Screws: AISI 304 stainless steel screws  
 Seals: Silicone Rubber

#### ELECTRICAL FEATURES

Driver: Integral ON-OFF or DALI  
 Voltage: 220-240V  
 Frequency: 50-60Hz  
 Wiring: Pre-wired and tested with resin sealed watertight

#### SOURCES

LED 4000K CRI>80 - 3000K CRI>80  
 MacAdam: Step 3  
 Lifetime: 50.000h L80B10 (Ta=25°C)

#### PERFORMANCE

Up to: 102 lm/W

#### CONTESTI

*Aree urbane/verdi, facciate e architetture, spazi d'accesso, illuminazione residenziale.*

#### CARATTERISTICHE FISICHE

Corpo: in alluminio pressofuso, resistente alla corrosione.  
 Cassaforma in tecnopolimero composito ad alta resistenza.  
 Telaio in acciaio inox AISI 316 sabbato.  
 Diffusore: Vetro temperato extra chiaro  
 Resistenza al carico statico: 3500 Kg  
 Viteria: Viteria inox AISI 304  
 Guarnizioni: Gomma ai siliconi

#### CARATTERISTICHE ELETTRICHE

Driver: Integrato ON-OFF o DALI  
 Tensione: 220-240V  
 Frequenza: 50-60Hz  
 Cablaggio: Completo di spezzone di cavo collaudato a tenuta

#### SORGENTI

LED 4000K CRI>80 - 3000K CRI>80  
 MacAdam: Step 3  
 Durata: 50.000h L80B10 (Ta=25°C)

#### PERFORMANCE

Fino a: 102 lm/W

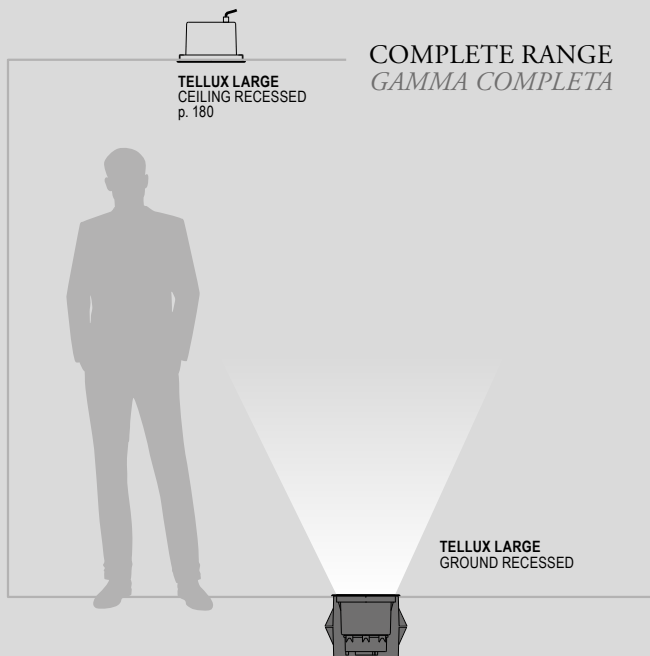

#### OPTIONAL ACCESSORIES

##### ACCESSORI OPZIONALI



Optional honeycomb anti-glare louver  
 (already included only for NB optic).  
 Griglia honeycomb antiabbagliamento  
 opzionale (già inclusa solo per ottica NB).

Accessories factory assembled.  
 Please order with products.  
 Accessori montati in fabbrica.  
 Si prega di ordinarli in contemporanea  
 con i prodotti.



# TELLUX LARGE

## SIZE / DIMENSIONI

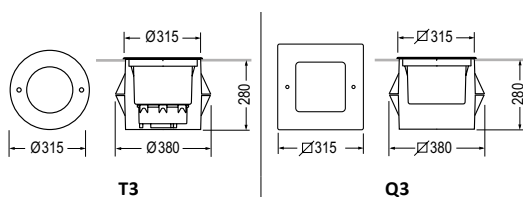

Size	Ø315 mm		315x315mm
Total system power max	36,6 W	43W COB	36,6 W
Lumen output max	3290 lm	4381 lm	3290 lm

## OPTIC / OTTICHE

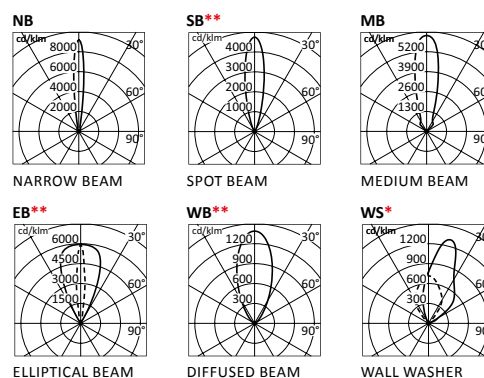

\* Only for /Solo per COB \*\* Only for /Solo per Volvendo

## PRODUCT CODES / CODICI PRODOTTO

**D 4 4 K / T 3 - 2 1 V L W N - M B**

PRODUCT PRODOTTO	LED	LIGHTING COLORS COLORI DELLA LUCE	BEAMS FASCI	CONTROLS CONTROLLI
D44K/T3 = TELLUX LARGE ground recessed	9V = VOLVENDO POWER LED 22,4W 21V = VOLVENDO POWER LED 36,6W 1 = COB 28W 2 = COB 43W	LWN = 4000K CRI>80 LWW = 3000K CRI>80	NB = NARROW BEAM SB** = SPOT BEAM MB = MEDIUM BEAM EB** = ELLIPTICAL BEAM WB** = WIDE BEAM WS* = WALL WASHER	Standard ON-OFF add/aggiungere DD = DALI

\* Only for /Solo per COB \*\* Only for /Solo per Volvendo Rough-in housing included /Casseforme incluse

**D 4 4 K / Q 3 - 2 1 V L W N - M B**

PRODUCT PRODOTTO	LED	LIGHTING COLORS COLORI DELLA LUCE	BEAMS FASCI	CONTROLS CONTROLLI
D44K/Q3 = TELLUX Q3 ground recessed	9V = VOLVENDO POWER LED 22,4W 21V = VOLVENDO POWER LED 36,6W	LWN = 4000K CRI>80 LWW = 3000K CRI>80	NB = NARROW BEAM SB = SPOT BEAM MB = MEDIUM BEAM EB = ELLIPTICAL BEAM WB = WIDE BEAM	Standard ON-OFF add/aggiungere DD = DALI

Rough-in housing included /Casseforme incluse

**BOLLARD**





**ENVIRONMENTS**

Urban landscape, hallway.

**PHYSICAL FEATURES**

Body: Load bearing structures in 8 mm thick screen-printed extra clear tempered glass with integrated line duct.  
 Connection elements in extruded aluminium and closure in coated AISI 304 stainless steel.

Diffuser: PC with surface treatment scratch-resistant and anti-aging UV rays.

Screws: AISI 304 stainless steel screws

**ELECTRICAL FEATURES**

Driver: ON-OFF  
 Voltage: 220-240V

**SOURCES**

LED 4000K CRI>80 - 3000K CRI>80  
 MacAdam: Step 2  
 Lifetime: 50.000h L80B10 (Ta=25°C)

**PERFORMANCE**

Up to: 113 lm/W

**CONTESTI**

Aree urbane/verdi, spazi d'accesso.

**CARATTERISTICHE FISICHE**

Corpo: Strutture portanti in vetro temperato extra chiaro spessore 8 mm con passaggio linea integrato.

Elementi di collegamento in alluminio estruso e chiusura in acciaio inox AISI 304 verniciato.

Diffusore: PC con trattamento superficiale antigraffio e anti invecchiamento ai raggi UV.

Viteria: Viteria inox AISI 304

**CARATTERISTICHE ELETTRICHE**

Driver: ON-OFF  
 Tensione: 220-240V

**SORGENTI**

LED 4000K CRI>80 - 3000K CRI>80  
 MacAdam: Step 2  
 Durata: 50.000h L80B10 (Ta=25°C)

**PERFORMANCE**

Fino a: 113 lm/W

COMPLETE RANGE  
 GAMMA COMPLETA

FLOAT BOLLARD

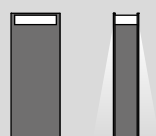

TECHNICAL FEATURES

CARATTERISTICHE TECNICHE

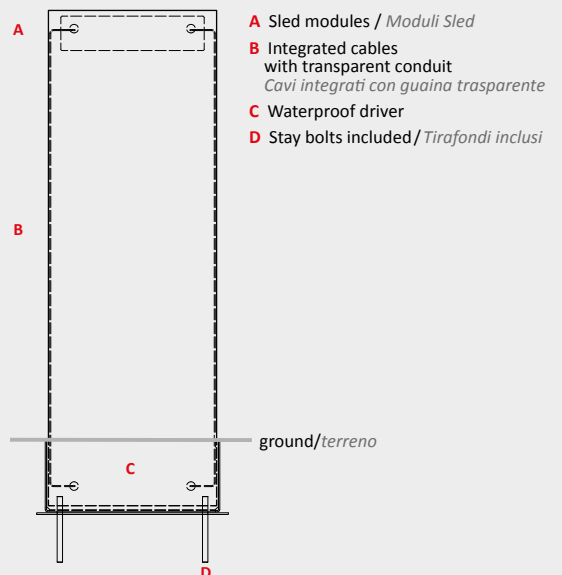

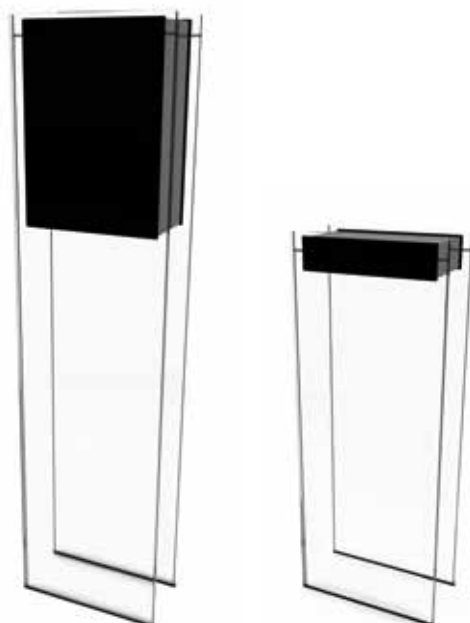

# FLOAT

DESIGN BY HABIT(S)

## SIZE / DIMENSIONI

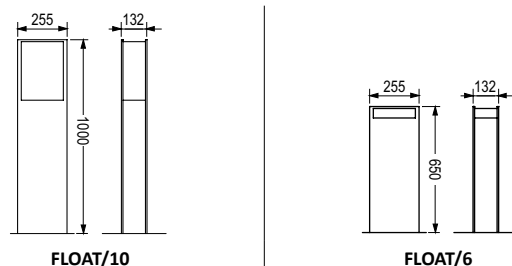

	FLOAT/10	FLOAT/6
Total system power	21W	11W
Lumen output max	2152 lm	1245 lm

## OPTIC / OTTICHE

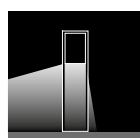

ASYMMETRIC

FLOAT/10-6

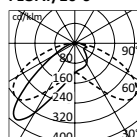

AS

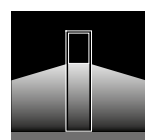
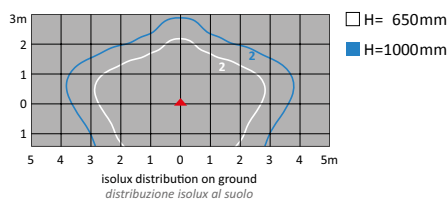

DIFFUSED

FLOAT/10

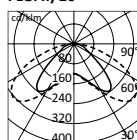

2AS

FLOAT/6

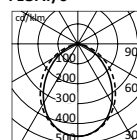

MF

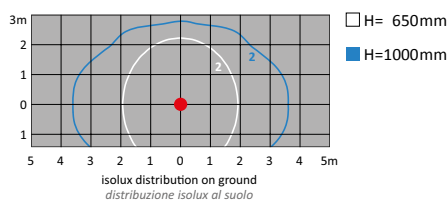

## PRODUCT CODES / CODICI PRODOTTO

# D 6 5 / 1 0 - 2 X 9 L W N - 2 A S - N

PRODUCT PRODOTTO	SIZE DIMENSIONI	LIGHTING COLORS COLORI DELLA LUCE	BEAMS FASCI	FINISH FINITURE
D65 = FLOAT	10-2x9 = H=1000mm (21W) 6-1x9 = H= 650mm (11W)	LWN = 4000K CRI>80 LWW = 3000K CRI>80	2AS* = DOUBLE ASYMMETRIC AS = ASYMMETRIC MF** = DIFFUSED BEAM	N = BLACK

\*Only for versions/ Solo per versioni FLOAT/10

\*\*Only for versions/ Solo per versioni FLOAT/6

Stay bolts included/ tirafondi inclusi







# KEA

DESIGN BY HABIT(S)

**ESSENTIAL LANGUAGE  
IN RESIDENTIAL DESIGN**  
*LINGUAGGIO ESSENZIALE IN  
DESIGN RESIDENZIALE*



GROUND  
BOLLARD

COMPLETE RANGE  
*GAMMA COMPLETA*

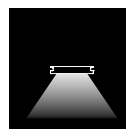

WALL SURFACE

p. 140



WALL SURFACE

p. 140



CEILING  
SURFACE

p. 196



 | IP65 | IK10 | CE | 

 | 
 | 
 | 

#### ENVIRONMENTS

Urban landscape, hallway, residential lighting.

#### PHYSICAL FEATURES

Painting: Polyester powder coating, with a multi-process treatment against corrosion (pass the exposure to over 1500 hours in a saline mist environment).

Body: Corrosion resistant extruded aluminium post. Corrosion resistant die-cast aluminium body.

Diffuser: Extra clear tempered glass

#### ELECTRICAL FEATURES

Driver: Integral ON-OFF or DALI

Voltage: 220-240V

Frequency: 50-60Hz

Wiring: Integral looping line

#### SOURCES

Sources: LED 3000K CRI>90 - 4000K CRI>80

MacAdam: Step 3

Lifetime: 60.000h L80B10 (Ta=25°C)

#### PERFORMANCE

Up to: 45 lm/W

#### CONTESTI

Aree urbane/verdi, spazi d'accesso, illuminazione residenziale.

#### CARATTERISTICHE FISICHE

Verniciatura: Verniciatura a polveri poliesteri, previo pluritrattamenti contro la corrosione (supera il test di 1500 ore in nebbia salina).

Corpo: Colonna in alluminio estruso, resistente alla corrosione. Corpo in alluminio pressofuso resistente alla corrosione.

Diffusore: Vetro temperato extra chiaro

#### CARATTERISTICHE ELETTRICHE

Driver: ON-OFF o DALI integrato

Tensione: 220-240V

Frequenza: 50-60Hz

Cablaggio: Linea passante interna

#### SORGENTI

Sorgenti: LED 3000K CRI>90 - 4000K CRI>80

MacAdam: Step 3

Durata: 60.000h L80B10 (Ta=25°C)

#### PERFORMANCE

Fino a: 45 lm/W

#### LOW POLE / BOLLARD

PALI BASSI / BOLLARD

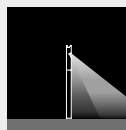

Single emission  
Monoemissione

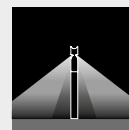

Double emission  
Biemissione

#### OPTIONAL ACCESSORIES

ACCESSORI OPZIONALI



KEA bollard counter plate with stay bolts.  
KEA bollard contropiastra con tirafondi.

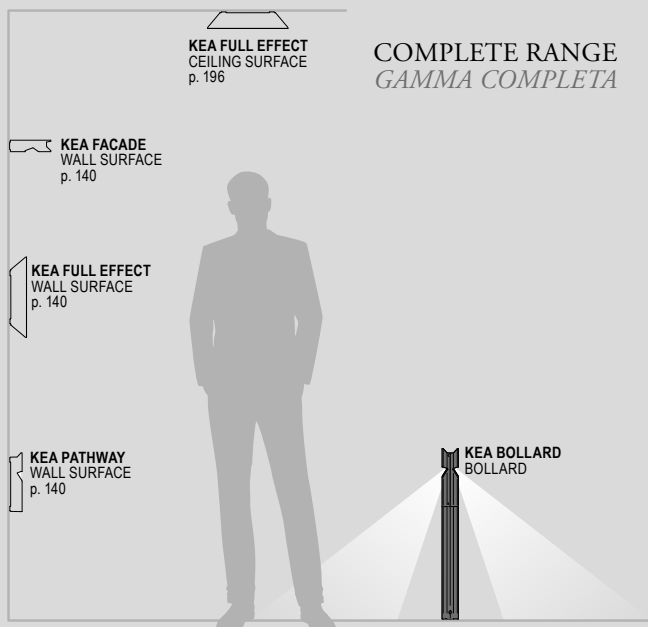



# KEA BOLLARD

DESIGN BY HABIT(S)

## SIZE / DIMENSIONI

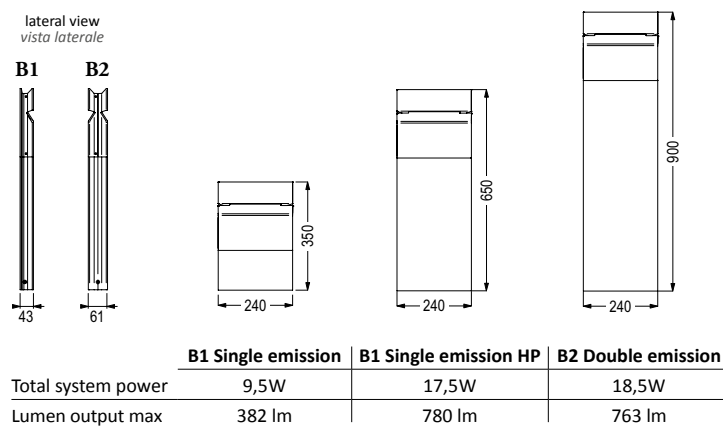

## OPTIC / OTTICHE

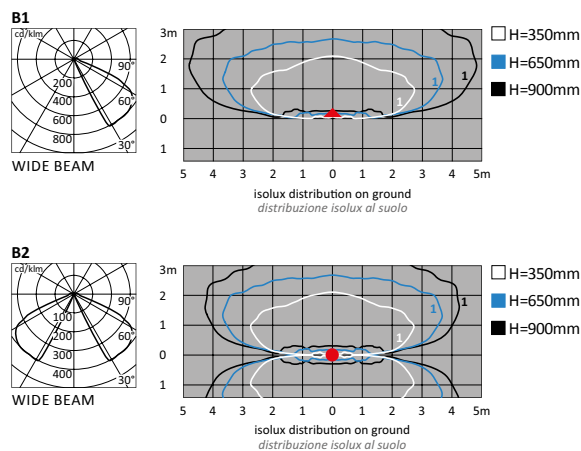

## PRODUCT CODES / CODICI PRODOTTO

# D 6 8 / B 1 - 9 3 - 6 5 0 - G R

PRODUCT PRODOTTO	VERSIONS VERSIONI	LIGHTING COLORS COLORI DELLA LUCE	SIZE DIMENSIONE	CONTROLS CONTROLLI	FINISH FINITURE
D68 = KEA	B1 = BOLLARD Single/ singola B2 = BOLLARD Double/ doppia	84 = 4000K CRI>80 93 = 3000K CRI>90 84HP* = 4000K CRI>80 93HP* = 3000K CRI>90	350 = H 350mm 650 = H 650mm 900 = H 900mm	standard ELECTRONIC add/aggiungere DD - = DALI	AL = ALUMINIUM GREY DN - EMBOSSED WHITE GR = GRAPHITE CO = CORTEN

\* HP= 17,5W Only for/ Solo per H=650/900mm



IP67 | IK10 | CE

AL GR

#### ENVIRONMENTS

Urban landscape, façades and architectural works, hallway.

#### PHYSICAL FEATURES

Painting: Polyester powder coating, with a multi-process treatment against corrosion (pass the exposure to over 1500 hours in a saline mist environment).

Body: Composite high resistance technopolymer fixing base. Corrosion resistant die-cast aluminum body.

Diffuser: PC with anti-aging UV rays

Screws: AISI 304 stainless steel hardware tampering-proof

Seals: Silicone Rubber

#### ELECTRICAL FEATURES

Driver: Integral ON-OFF

Voltage: 220-240V

Frequency: 50-60Hz

Wiring: Complete with pre-wired and tested watertight H07RN-F cable.

#### SOURCES

LED COB 4000K CRI>80 - 3000K CRI>80

MacAdam: Step 3

Lifetime: 50.000h L80B20 (Ta=25°C)

#### PERFORMANCE

Up to: 45 lm/W

#### CONTESTI

Aree urbane/verdi, facciate e architetture, spazi d'accesso.

#### CARATTERISTICHE FISICHE

Verniciatura: a polveri poliesteri, previo pluritrattamenti contro la corrosione (supera il test di 1500 ore in nebbia salina).

Corpo: Base di fissaggio in tecnopolimero composito ad alta resistenza.

Corpo in alluminio pressofuso, resistente alla corrosione.

Diffusore: PC con anti invecchiamento ai raggi UV

Viteria: inox AISI 304, antieffrazione

Guarnizioni: Gomma ai siliconi

#### CARATTERISTICHE ELETTRICHE

Driver: ON-OFF

Tensione: 220-240V

Frequenza: 50-60Hz

Cablaggio: Completo di spezzone di cavo H07RN-F già collegato e collaudato a tenuta.

#### SORGENTI

LED COB 4000K CRI>80 - 3000K CRI>80

MacAdam: Step 3

Durata: 50.000h L80B20 (Ta = 25°C)

#### PERFORMANCE

Fino a: 45 lm/W

## COMPLETE RANGE GAMMA COMPLETA

 **MINIZACK**  
WALL SURFACE  
p. 146



**MINIZACK**  
BOLLARD



**ZACK**  
BOLLARD  
p. 104



## OPTIONAL ACCESSORIES ACCESSORI OPZIONALI



**Pit**  
Pozzetto

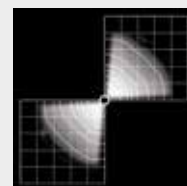

**Darkening shield**  
Settore oscurante



**Opening key**  
Chiave di apertura  
apparecchio



# MINIZACK

## SIZE / DIMENSIONI

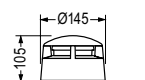

Total system power	6 W
Lumen output max	270 lm

## OPTIC / OTTICHE

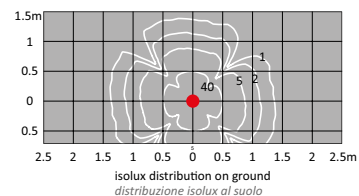
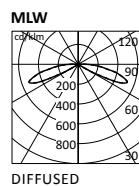

## PRODUCT CODES / CODICI PRODOTTO

# D 3 2 / M L W N - A L

PRODUCT PRODOTTO	LIGHTING COLORS COLORI DELLA LUCE	FINISH FINITURE
D32 = MINIZACK	MLWN = 4000K CRI>80 MLWW = 3000K CRI>80	AL = ALUMINIUM GREY GR = GRAPHITE



IP67 | IK10 | CE | 

AL | GR

#### ENVIRONMENTS

Urban landscape, hallway, residential lighting.

#### PHYSICAL FEATURES

Painting: Polyester powder coating, with a multi-process treatment against corrosion (pass the exposure to over 1500 hours in a saline mist environment).

Body: Corrosion resistant extruded aluminium body.  
Corrosion resistant die-cast aluminium end caps.

Diffuser: Extra clear tempered glass

Screws: AISI 304 stainless steel

Seals: Silicone Rubber

#### ELECTRICAL FEATURES

Driver: Integral ON-OFF or DALI

Voltage: 220-240V

Frequency: 50-60Hz

Wiring: Internal looping facility with two H07RN-F pre-wired and tested.

#### SOURCES

LED 4000K CRI>80 - 3000K CRI>80

MacAdam: Step 3

Lifetime: 50.000h L80B50 (Ta=25°C)

#### PERFORMANCE

Up to: 63 lm/W

#### CONTESTI

Aree urbane/verdi, spazi d'accesso, illuminazione residenziale.

#### CARATTERISTICHE FISICHE

Verniciatura: a polveri poliesteri, previo pluritrattamenti contro la corrosione (supera il test di 1500 ore in nebbia salina).

Corpo: in alluminio estruso, resistente alla corrosione.

Testate di chiusura pressofuse in alluminio resistente alla corrosione.

Diffusore: Vetro temperato extra chiaro

Viteria: Inox AISI 304

Guarnizioni: Gomma ai siliconi

#### CARATTERISTICHE ELETTRICHE

Driver: integrato ON-OFF o DALI

Tensione: 220-240V

Frequenza: 50-60Hz

Cablaggio: Derivazione interna già predisposta con cavi in uscita tipo H07RN-F già collegati e collaudati a tenuta.

#### SORGENTI

LED 4000K CRI>80 - 3000K CRI>80

MacAdam: Step 3

Durata: 50.000h L80B50 (Ta=25°C)

#### PERFORMANCE

Fino a: 63 lm/W

NASTER  
CEILING RECESSED  
p. 170

### COMPLETE RANGE GAMMA COMPLETA

NASTER  
WALL RECESSED  
p. 110

NASTER  
GROUND RECESSED  
p. 62

NASTER  
BOLLARD

LOW POLE/BOLLARD  
PALI BASSI/BOLLARD

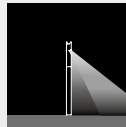

Single emission  
Monoemissione



# MASTER

DESIGN BY EMANUELA PULVIRENTI

## SIZE / DIMENSIONI

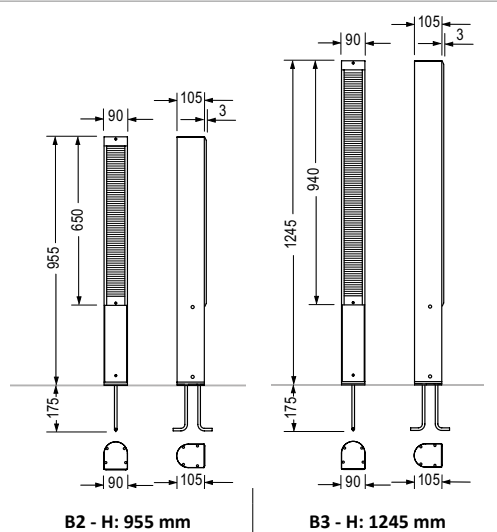

Total system power	20 W	28 W
Lumen output max	1084 lm	1781 lm

## OPTIC / OTTICHE

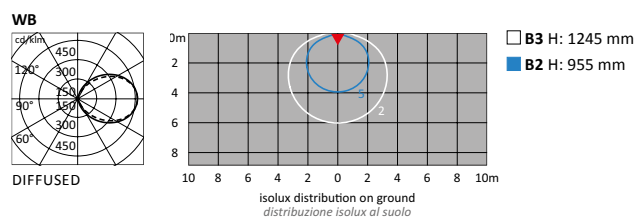

## PRODUCT CODES / CODICI PRODOTTO

**D 4 9 / B 2 - L W N - W B - A L**

PRODUCT PRODOTTO	SIZE DIMENSIONI	LIGHTING COLORS COLORI DELLA LUCE	OPTICS OTTICHE	CONTROLS CONTROLLI	FINISH FINITURE
D49 = MASTER	B2 = H: 955 mm - 20 W B3 = H: 1245 mm - 28 W	LWN = 4000K CRI>80 LWW = 3000K CRI>80	WB: Wide beam Fascio diffuso	Standard Electronic add/aggiungere DD = DALI	AL = ALUMINIUM GREY GR = GRAPHITE

Stay bolts included / tirafondi inclusi



⊕ | IP65 | IK08 | CE

AL | GR

#### ENVIRONMENTS

Urban landscape, hallway, residential lighting

#### PHYSICAL FEATURES

Painting: Powder coat painting after multi-layer polyester pre-treatment for corrosion resistance.

Body: Housing made of AISI 304 stainless steel brake-formed and fully TIG welded, powder-coated.

Diffuser: PC with surface treatment scratch-resistant and anti-aging UV rays.

Screws: AISI 304 stainless steel screws

#### ELECTRICAL FEATURES

Driver: Integral ON-OFF

Voltage: 220-240V

Frequency: 50-60Hz

#### SOURCES

LED 4000K CRI>80 - 3000K CRI>80

MacAdam: Step 3

Lifetime: 50.000h L80B10 (Ta=25°C)

#### PERFORMANCE

Up to: 41 lm/W

#### CONTESTI

Aree urbane/verdi, spazi d'accesso, illuminazione residenziale.

#### CARATTERISTICHE FISICHE

Verniciatura: a polveri previo pre-trattamento con multistrato in poliestere ad alta resistenza alla corrosione.

Corpo: Struttura in lamiera di acciaio inox AISI 304 presso-piegata, elettrosaldata a TIG, verniciata a polvere.

Diffusore: PC con trattamento superficiale antigraffio e anti invecchiamento ai raggi UV.

Viteria: Inox AISI 304

#### CARATTERISTICHE ELETTRICHE

Driver: Integrato ON-OFF

Tensione: 220-240V

Frequenza: 50-60Hz

#### SORGENTI

LED 4000K CRI>80 - 3000K CRI>80

MacAdam: Step 3

Durata: 50.000h L80B10 (Ta = 25 ° C)

#### PERFORMANCE

Fino a: 41 lm/W

#### BOLLARD

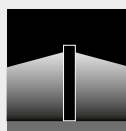

**Double emission**  
Biemissione

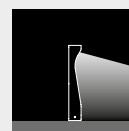

**Single emission**  
Monoemissione

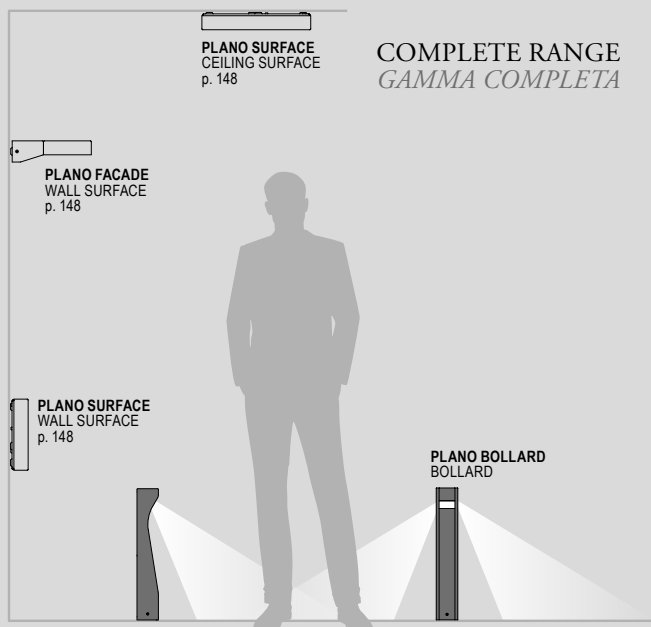

#### OPTIONAL ACCESSORIES

##### ACCESSORI OPZIONALI



Counter plate with stay bolts.  
Contropiastra con tirafondi.





# PLANO

## SIZE / DIMENSIONI

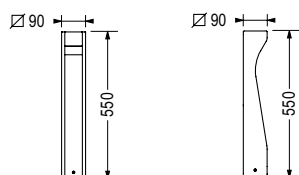

**F4 - Double emission**      **F4 - Single emission**

Total system power	6 W	6 W
Lumen output max	250 lm	230 lm

## OPTIC / OTTICHE

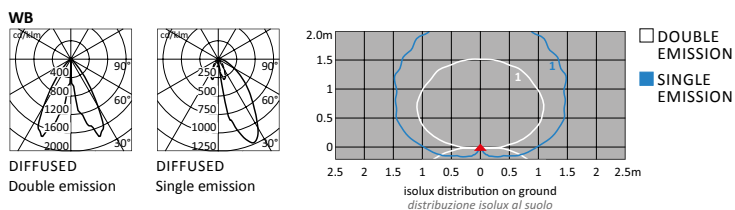

## PRODUCT CODES / CODICI PRODOTTO

# 2801 - GR - C21A

PRODUCT PRODOTTO	FINISH FINITURE	LIGHTING COLORS COLORI DELLA LUCE
2801 = PLANO Bollard double emission 2802 = PLANO Bollard single emission	AL = ALUMINIUM GREY GR = GRAPHITE	Please visit website Visita il sito internet example/eseempio: C21A = 3000K CRI>80











#### ENVIRONMENTS

Urban landscape, hallway, residential lighting.

#### PHYSICAL FEATURES

Painting: Polyester powder coating, with a multi-process treatment against corrosion (pass the exposure to over 1500 hours in a saline mist environment).

Body: Corrosion resistant extruded aluminium post.  
Corrosion resistant die-cast aluminium body.  
Corrosion resistant aluminium ground fixing base.

Diffuser: PC with anti-aging UV rays  
Screws: AISI 304 stainless steel screws  
Seals: Silicone Rubber Gaskets

#### ELECTRICAL FEATURES

Driver: Integral ON-OFF or DALI  
Voltage: 220-240V  
Frequency: 50-60Hz  
Wiring: Integral looping line

#### SOURCES

LED 4000K CRI>80 - 3000K CRI>80  
MacAdam: Step 3 POLO/T1 - Step 2 POLO/T2  
Lifetime: 50.000h L80B20 (Ta=25°C) POLO/T1  
60.000h L90B10 (Ta=25°C) POLO/T2

#### PERFORMANCE

Up to: 96 lm/W

#### CONTESTI

Aree urbane/verdi, spazi d'accesso, illuminazione residenziale.

#### CARATTERISTICHE FISICHE

Verniciatura: a polveri poliesteri, previo pluritrattamenti contro la corrosione (supera il test di 1500 ore in nebbia salina).  
Corpo: Colonna in alluminio estruso, resistente alla corrosione.  
Corpo in alluminio pressofuso resistente alla corrosione.  
Base di fissaggio a pavimento in alluminio pressofuso resistente alla corrosione.

Diffusore: PC con anti invecchiamento ai raggi UV  
Viteria: Inox AISI 304  
Guarnizioni: Gomma ai siliconi

#### CARATTERISTICHE ELETTRICHE

Driver: Integrato ON-OFF o DALI  
Tensione: 220-240V  
Frequenza: 50-60Hz  
Cablaggio: Linea passante interna

#### SORGENTI

LED 4000K CRI>80 - 3000K CRI>80  
MacAdam: Step 3 POLO/T1 - Step 2 POLO/T2  
Lifetime: 50.000h L80B20 (Ta=25°C) POLO/T1  
60.000h L90B10 (Ta=25°C) POLO/T2

#### PERFORMANCE

Fino a: 96 lm/W

#### BOLLARD



Diffused  
Diffuso

#### OPTIONAL ACCESSORIES ACCESSORI OPZIONALI



Counter plate  
with stay bolts.  
Contropiastra  
con tirafondi.



Darkening sector  
180° wide.  
Settore oscurante  
ampiezza 180°.

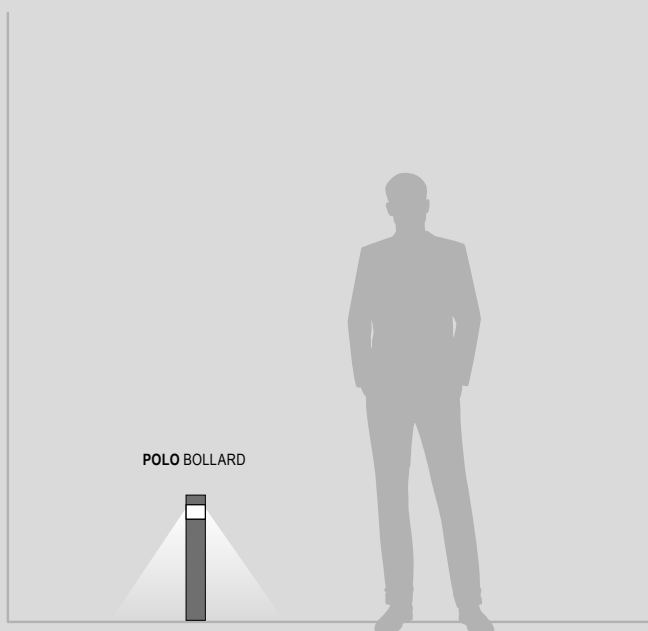



# POLO

## SIZE / DIMENSIONI

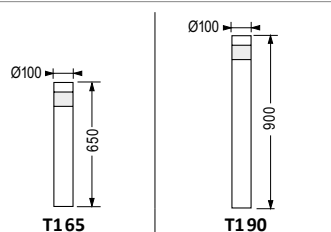

Total system power	10 W
Lumen output max	864 lm

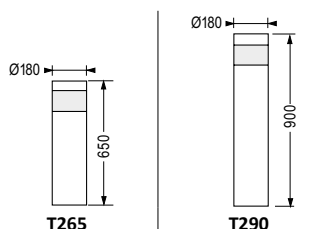

Total system power	25 W
Lumen output max	2401 lm

## OPTIC / OTTICHE

### POLO/T1

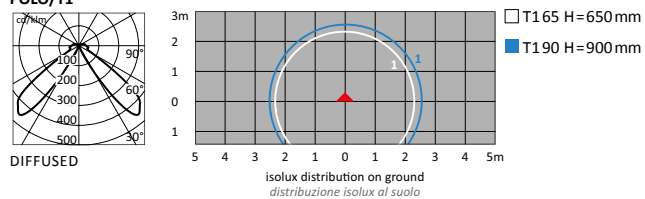

### POLO/T2

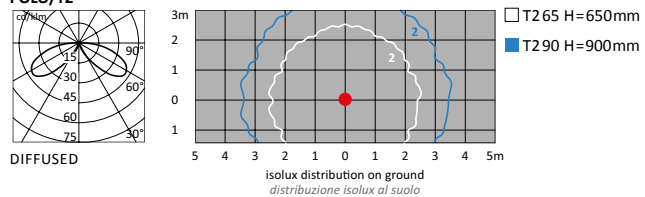

## PRODUCT CODES / CODICI PRODOTTO

# D 5 3 / T 1 6 5 - 8 4 - A L

PRODUCT PRODOTTO	SIZE DIMENSIONI	HEIGHT ALTEZZA	LIGHTING COLORS COLORI DELLA LUCE	CONTROLS CONTROLLI	FINISH FINITURE
D53 = POLO	T1 = Ø 100mm - 10W T2 = Ø 180mm - 25W	65 = 650mm 90 = 900mm	83 = 3000K CRI>80 84 = 4000K CRI>80	Standard Electronic add/aggiungere DD = DALI	AL = ALUMINIUM GREY GR = GRAPHITE



IP65 | IK08 | CE |

AL | GR

#### ENVIRONMENTS

Urban landscape, hallway

#### PHYSICAL FEATURES

Painting: Polyester powder coating, with a multi-process treatment against corrosion (pass the exposure to over 1500 hours in a saline mist environment).

Body: Corrosion resistant die-cast aluminium body

Diffuser: Extra clear tempered glass

Screws: AISI 304 stainless steel screws

Seals: Silicone Rubber

#### ELECTRICAL FEATURES

Driver: Integral ON-OFF or DALI

Voltage: 220-240V

Frequency: 50-60Hz

Wiring: Complete with pre-wired and tested watertight H07RN-F cable.

#### SOURCES

LED 4000K CRI>80 - 3000K CRI>80

MacAdam: Step 3

Lifetime: 50.000h L80B20 (Ta=25°C)

#### PERFORMANCE

Up to: 51 lm/W

#### CONTESTI

Aree urbane/verdi, spazi d'accesso

#### CARATTERISTICHE FISICHE

Verniciatura: a polveri poliesteri, previo pluritrattamenti contro la corrosione (supera il test di 1500 ore in nebbia salina).

Corpo: Alluminio pressofuso, resistente alla corrosione

Diffusore: Vetro temperato extra chiaro

Viteria: Viteria inox AISI 304

Guarnizioni: Gomma ai silicani

#### CARATTERISTICHE ELETTRICHE

Driver: integrato ON-OFF o DALI

Tensione: 220-240V

Frequenza: 50-60Hz

Cablaggio: Completo di spezzone di cavo H07RN-F già collegato e collaudato a tenuta.

#### SORGENTI

LED 4000K CRI>80 - 3000K CRI>80

MacAdam: Step 3

Durata: 50.000h L80B20 (Ta = 25° C)

#### PERFORMANCE

Fino a: 51 lm/W

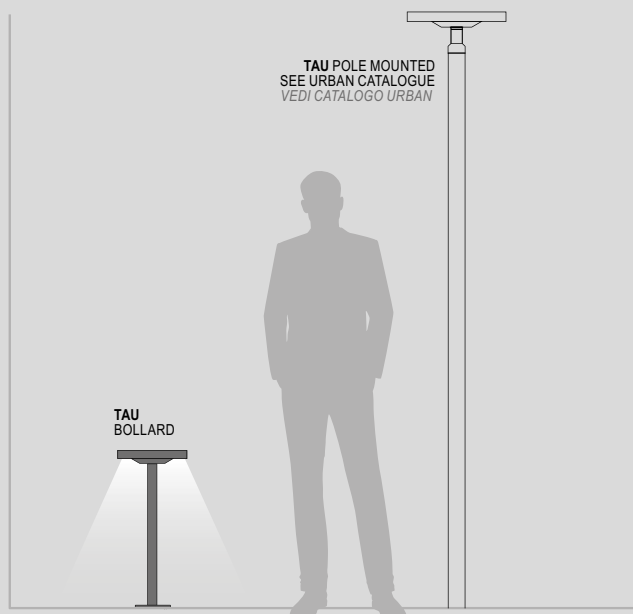

#### OPTIONAL ACCESSORIES

##### ACCESSORI OPZIONALI

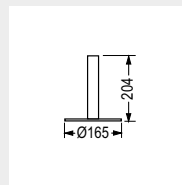

Independent fixing base for low poles.  
Base di fissaggio indipendente per il fissaggio dei pali bassi.

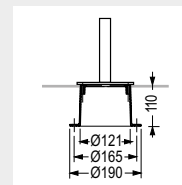

Ground recessed pit with fixing base.  
Pozzetto da incasso nel terreno.

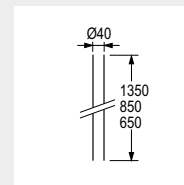

Ø40mm aluminium poles.  
Pali di sostegno in alluminio Ø40mm  
Height/Altezza:  
- 1350mm  
- 850mm  
- 650mm



# TAU

## SIZE / DIMENSIONI

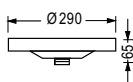

**TAU/1**

Total system power	10 W
Lumen output max	510 lm

## OPTIC / OTTICHE

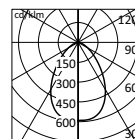

ROTSYMMETRIC

## PRODUCT CODES / CODICI PRODOTTO

# **D 4 3 / 1 - L W N - G R**

PRODUCT PRODOTTO	SIZE DIMENSIONI	LIGHTING COLORS COLORI DELLA LUCE	CONTROLS CONTROLLI	FINISH FINITURE
<b>D43</b> = TAU	1 = Ø 290 mm (10 W)	<b>LWN</b> = 4000K CRI>80 <b>LWW</b> = 3000K CRI>80	Standard Electronic add/aggiungere <b>DD</b> = DALI	<b>AL</b> = ALUMINIUM GREY <b>GR</b> = GRAPHITE



□ | IP65 | IK08 | CE

#### ENVIRONMENTS

Urban landscape, hallway, residential lighting.

#### PHYSICAL FEATURES

Body: Housing made of natural stone

#### ELECTRICAL FEATURES

Driver: Integral ON-OFF

Voltage: 220-240V

Frequency: 50-60Hz

Wiring: Complete with pre-wired and tested watertight H07RN-F cable with IP connector.

#### SOURCES

LED 3000K CRI>80

MacAdam: Step 3

Lifetime: 50.000h L80B20 (Ta 25°)

#### PERFORMANCE

Up to: 49 lm/W

#### CONTESTI

Aree urbane/verdi, spazi d'accesso, illuminazione residenziale.

#### CARATTERISTICHE FISICHE

Corpo: Struttura in pietra naturale

#### CARATTERISTICHE ELETTRICHE

Driver: integrato ON-OFF

Tensione: 220-240V

Frequenza: 50-60 Hz

Cablaggio: Completo di spezzone di cavo H07RN-F già collegato e collaudato a tenuta e connettore IP.

#### SORGENTI

LED 3000K CRI>80

MacAdam: Step 3

Lifetime: 50.000h L80B20 (Ta=25°C)

#### PERFORMANCE

Fino a: 49 lm/W

### COMPLETE RANGE GAMMA COMPLETA

USEPARTOUT SUPERFLAT  
WALL SURFACE  
p. 158

USEPARTOUT SUPERSTONE  
BOLLARD

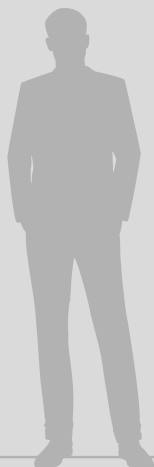

### FINISH/FINITURE



Bianco Carrara



Crema Marfil



Nero assoluto

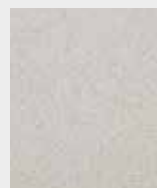

Pietra serena



Verde Guatemala



# USEPARTOUT SUPERSTONE

DESIGN BY JOERG KREWINKEL

## SIZE / DIMENSIONI

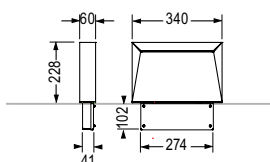

Total system power	9 W
Lumen output max	475 lm

## OPTIC / OTTICHE

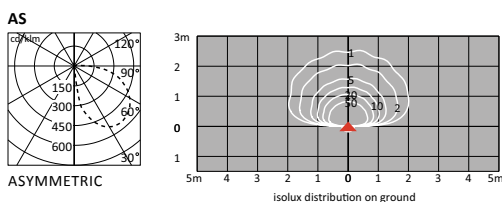

## PRODUCT CODES / CODICI PRODOTTO

**4050 / EL83 - \* \***

PRODUCT PRODOTTO	CONTROLS CONTROLLI	LIGHTING COLORS COLORI DELLA LUCE	FINISH FINITURE
4050 = USEPARTOUT SUPERSTONE	EL = ON OFF	83 = 3000K CRI>80 84 = 4000K CRI>80	Different natural stone available. Please contact our sales department. ** = Sono disponibili diverse finiture in pietra naturale. Si prega di contattare il nostro staff commerciale.



IP65 | IK08 | CE

GR CO

#### ENVIRONMENTS

Urban landscape, hallway, residential lighting.

#### PHYSICAL FEATURES

Painting: Polyester powder coating, with a multi-process treatment against corrosion (pass the exposure to over 1500 hours in a saline mist environment).

Body: Housing made of AISI 304 stainless steel brake-formed and fully TIG welded, powder-coated.

Diffuser: PC with surface treatment scratch-resistant and anti-aging UV rays.

Screws: AISI 304 stainless steel screws

#### ELECTRICAL FEATURES

Driver: ON-OFF or DALI (only h. 100cm)

Voltage: 220-240V

Frequency: 50-60Hz

Wiring: Complete with pre-wired and tested watertight H07RN-F cable.

#### SOURCES

LED 4000K CRI>80 - 3000K CRI>80

MacAdam: Step 2

Lifetime: 50.000h L80B10 (Ta=25°C)

#### PERFORMANCE

Up to: 110 lm/W

#### CONTESTI

Aree urbane/verdi, spazi d'accesso, illuminazione residenziale.

#### CARATTERISTICHE FISICHE

Verniciatura: a polveri poliesteri, previo pluritrattamenti contro la corrosione (supera il test di 1500 ore in nebbia salina).

Corpo: Struttura in lamiera di acciaio inox AISI 304 presso-piegata, elettrosaldata a TIG, verniciata a polvere.

Diffusore: PC con trattamento superficiale antigraffio e anti invecchiamento ai raggi UV.

Viteria: Inox AISI 304

#### CARATTERISTICHE ELETTRICHE

Driver: ON-OFF o DALI (solo per h. 100cm)

Tensione: 220-240V

Frequenza: 50-60Hz

Cablaggio: Completo di spezzone di cavo H07RN-F già collegato e collaudato a tenuta.

#### SORGENTI

LED 4000K CRI>80 - 3000K CRI>80

MacAdam: Step 2

Durata: 50.000h L80B10 (Ta=25°C)

#### PERFORMANCE

Fino a: 110 lm/W

### COMPLETE RANGE GAMMA COMPLETA

VERY APPLIQUE  
WALL SURFACE  
p. 162

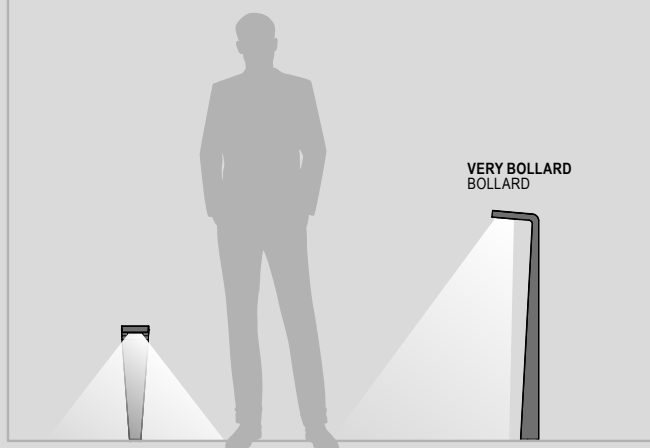

VERY BOLLARD  
BOLLARD





# VERY BOLLARD

DESIGN BY LUCHESEDESIGN

## SIZE / DIMENSIONI

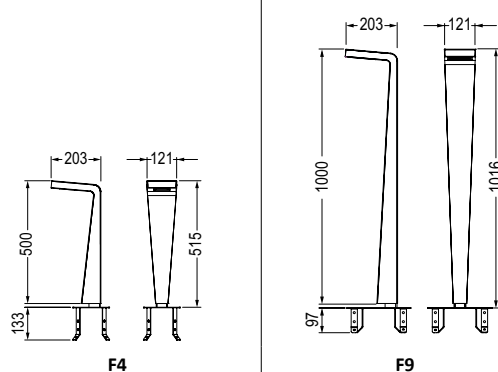

	F4	F9
Total system power	6 W	11 W
Lumen output max	544 lm	1200 lm

## OPTIC / OTTICHE

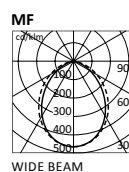

WIDE BEAM

## PRODUCT CODES / CODICI PRODOTTO

# 3 0 0 1 - G R - C 2 3 A

PRODUCT PRODOTTO	FINISH FINITURE	LIGHTING COLORS & BEAMS COLORI DELLA LUCE & FASCI
3001 = VERY H=500 3002 = VERY H=1000	GR = GRAPHITE CO = CORTEN	C23A* = 3000K CRI>80 diffused C24A* = 4000K CRI>80 diffused C25A** = 3000K CRI>80 diffused C26A** = 4000K CRI>80 diffused

\*Only for/ Solo per H=500    \*\*Only for/ Solo per H=1000

**ENVIRONMENTS**

Urban landscape, façades and architectural works, hallway.

**PHYSICAL FEATURES**

Painting: Polyester powder coating, with a multi-process treatment against corrosion (pass the exposure to over 1500 hours in a saline mist environment).

Body: Composite high resistance technopolymer fixing base. Corrosion resistant die-cast aluminum body.

Diffuser: PC with anti-aging UV rays

Screws: AISI 304 stainless steel

Seals: Silicone Rubber

**ELECTRICAL FEATURES**

Driver: Integral ON-OFF or DALI

Voltage: 220-240V

Frequency: 50-60Hz

Wiring: Complete with pre-wired and tested watertight H07RN-F cable.

**SOURCES**

LED COB 4000K CRI>80 - 3000K CRI>80

MacAdam: Step 2

Lifetime: 70.000h L90B10 (Ta=25°C)

**PERFORMANCE**

Up to: 50 lm/W

**CONTESTI**

Aree urbane/verdi, facciate e architetture, spazi d'accesso.

**CARATTERISTICHE FISICHE**

Verniciatura: a polveri poliesteri, previo pluritrattamenti contro la corrosione (supera il test di 1500 ore in nebbia salina).

Corpo: Base di fissaggio in tecnopolimero composito ad alta resistenza.

Corpo in alluminio pressofuso, resistente alla corrosione.

Diffusore: PC con anti invecchiamento ai raggi UV

Viteria: Inox AISI 304

Guarnizioni: Gomma ai siliconi

**CARATTERISTICHE ELETTRICHE**

Driver: ON-OFF o DALI

Tensione: 220-240V

Frequenza: 50-60Hz

Cablaggio: Completo di spezzone di cavo H07RN-F già collegato e collaudato a tenuta

**SORGENTI**

LED COB 4000K CRI>80 - 3000K CRI>80

MacAdam: Step 2

Durata: 70.000h L90B10 (Ta=25°C)

**PERFORMANCE**

Fino a: 50 lm/W



COMPLETE RANGE  
GAMMA COMPLETA

MINIZACK  
WALL SURFACE  
p. 146

MINIZACK  
BOLLARD  
p. 90

ZACK  
BOLLARD



OPTIONAL ACCESSORIES

ACCESSORI OPZIONALI



Pit  
Pozzetto

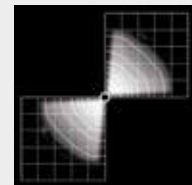

Darkening shield  
Settore oscurante



# ZACK

## SIZE / DIMENSIONI

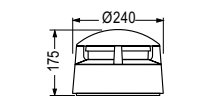

Total system power	25 W
Lumen output max	1260 lm

## OPTIC / OTTICHE

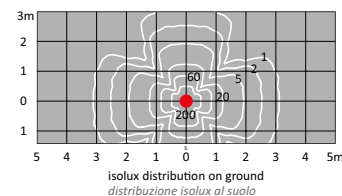
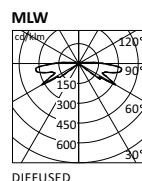

## PRODUCT CODES / CODICI PRODOTTO

# D 3 1 / M L W N - A L

PRODUCT PRODOTTO	LIGHTING COLORS COLORI DELLA LUCE	CONTROLS CONTROLLI	FINISH FINITURE
D31 = ZACK	MLWN = 4000K CRI>80 MLWW = 3000K CRI>80	standard ELECTRONIC add/aggiungere DD - = DALI	AL = ALUMINIUM GREY GR = GRAPHITE

**WALL RECESSED**





IP67 | IK07 | CE |

#### ENVIRONMENTS

Façades and architectural works, wellness, hallway, industrial areas.

#### PHYSICAL FEATURES

Body: Natural anodised extruded aluminium structure.  
Die-cast aluminium end caps.  
Installation kit with harmonic steel springs.  
Diffuser: Extra clear tempered glass

#### ELECTRICAL FEATURES

Driver: remote, ON-OFF or DALI  
Voltage: 21-25V-DC  
Wiring: Remote electrical harness wired for 220-240V-AC 50-60Hz,  
24V-DC output (accessories to be ordered separately).  
Integrated through wiring.

#### SOURCES

LED 4000K CRI>80 - 3000K CRI>80  
MacAdam: Step 3  
Lifetime: 70.000h L80B10 (Ta=25°C)

#### PERFORMANCE

Up to: 61 lm/W  
Up to: 945 lm/m

#### CONTESTI

Facciate e architetture, wellness, spazi d'accesso, industria.

#### CARATTERISTICHE FISICHE

Corpo: Struttura in estruso di alluminio anodizzato naturale.  
Testate in pressofusione di alluminio.  
Kit di installazione con molle in acciaio armonico.  
Diffusore: Vetro temperato extra chiaro

#### CARATTERISTICHE ELETTRICHE

Driver: Remoto, ON-OFF o DALI  
Tensione: 21-25V-DC  
Cablaggio: Elettrico con alimentatori remoti a 220-240V-AC  
50-60Hz, uscita 24V-DC (accessori da ordinare separatamente).  
Cablaggio passante integrato.

#### SORGENTI

LED 4000K CRI>80 - 3000K CRI>80  
MacAdam: Step 3  
Durata: 70.000h L80B10 (Ta=25°C)

#### PERFORMANCE

Fino a: 61 lm/W  
Fino a: 945 lm/m

## EASY AND FAST INSTALLATION

### INSTALLAZIONE FACILE E VELOCE



5 second IP67. Loop connection facility

Predisposizione per il collegamento loop - IP67 in 5 secondi

## HOW TO ORDER / COME ORDINARE

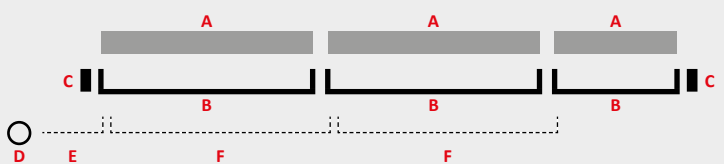

- A** Choose lighting modules /Scegli i corpi illuminanti
- B** Match the rough-in housing /Abbina le casseforme
- C** Provide end caps (only for frame version)  
Prevedi le testate di chiusura (solo per casseforme frame)
- D** Choose drivers/Scegli i driver
- E** 1 starting cables for each drivers /1 starting cable per ogni driver
- F** Provide looping line (dimension in according to lighting modules lengths)  
Looping cable (dimensione a seconda delle lunghezze dei prodotti)

ICE CEILING RECESSED  
p. 168

ICE WALL SURFACE  
p. 138

ICE WALL RECESSED

ICE GROUND  
p. 54

## COMPLETE RANGE GAMMA COMPLETA





# ICE

## SIZE / DIMENSIONI

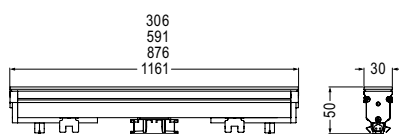

	306 mm	591 mm	876 mm	1161 mm
Total system power	4,5W	9W	13,5W	18W
Lumen output max	275 lm	548 lm	823 lm	1097 lm

## OPTIC / OTTICHE

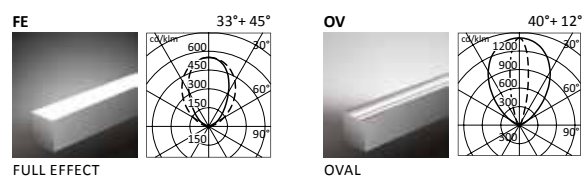

## ROUGH-IN / CASSEFORME



## PRODUCT CODES / CODICI PRODOTTO

# D 6 4 / 3 - 0 3 - 1 L W W - F E

PRODUCT PRODOTTO	SIZE DIMENSIONI	LIGHTING COLORS COLORI DELLA LUCE	OPTICS OTTICHE
D64 = ICE	3-03 = 306mm 3-06 = 591mm 3-09 = 876mm 3-12 = 1161mm	1 LWN = 4000K CR180 1 LWW = 3000K CR180	FE: Full effect OV: Oval

To be order separately: Rough-in housing, end caps, staning cable, looping cable, driver.  
 Da ordinare separatamente: casseforme, testate di chiusura, staning cable, looping cable, driver.



#### ENVIRONMENTS

Façades and architectural works, hallway, industrial areas, railway areas, subway areas.

#### PHYSICAL FEATURES

Painting: Polyester powder coating, with a multi-process treatment against corrosion (pass the exposure to over 1500 hours in a saline mist environment).

Body: Corrosion resistant extruded aluminium body.  
Corrosion resistant die-cast aluminium end caps.

Diffuser: Extra clear tempered glass

#### ELECTRICAL FEATURES

Driver: Integral, ON-OFF or DALI

Voltage: 220-240V

Frequency: 50-60Hz

Wiring: Internal looping facility with two rubber cable resin sealed.

#### SOURCES

LED 4000K CRI>80 - 3000K CRI>80 - RGBW

MacAdam: Step 3

Lifetime: 50.000h L80B50 (Ta=25°C)

#### PERFORMANCE

Up to: 83 lm/W

#### CONTESTI

Facciate e architetture, spazi d'accesso, industria, aree ferroviarie, aree metropolitane.

#### CARATTERISTICHE FISICHE

Verniciatura: a polveri poliesteri, previo pluritrattamenti contro la corrosione (supera il test di 1500 ore in nebbia salina)

Corpo: in alluminio estruso, resistente alla corrosione.

Testate di chiusura pressofuse in alluminio resistente alla corrosione.

Diffusore: Vetro temperato extra chiaro

#### CARATTERISTICHE ELETTRICHE

Driver: Integrato, ON-OFF o DALI

Tensione: 220-240V

Frequenza: 50-60Hz

Cablaggio: Derivazione interna già predisposta con due cavi in uscita resinati.

#### SORGENTI

LED 4000K CRI>80 - 3000K CRI>80 - RGBW

MacAdam: Step 3

Lifetime: 50.000h L80B50 (Ta=25°C)

#### PERFORMANCE

Fino a: 83 lm/W

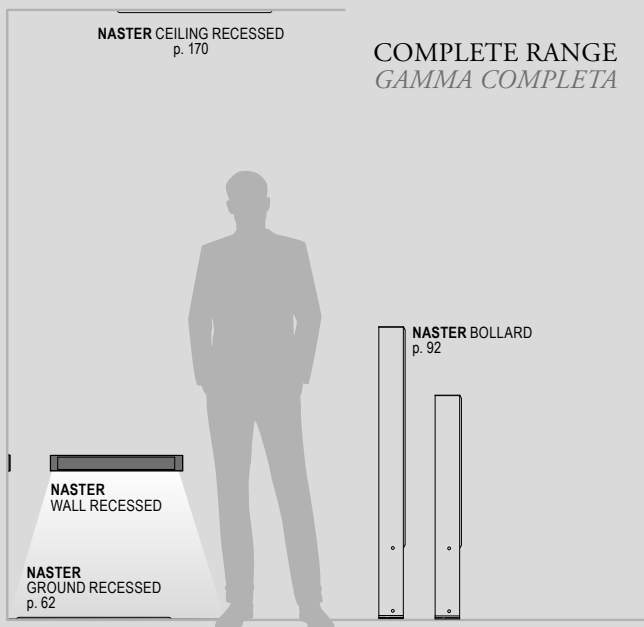

#### ACCESSORIES / ACCESSORI



Honeycomb louver for Wall Grazing optic.

Honeycomb antiabbagliamento per ottica Wall Grazing.

Accessories factory assembled. Please order with products.

Accessori montati in fabbrica.

Si prega di ordinarli in contemporanea con i prodotti.





# MASTER

DESIGN BY EMANUELA PULVIRENTI

## SIZE / DIMENSIONI

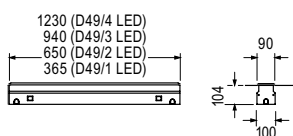

	365 mm	650 mm	650 mm	940 mm	940 mm	1230 mm	1230 mm
Total system power	12W	20W	30W	28W	44W	37W	57W
Lumen output max	997 lm	1661 lm	933 lm	2326 lm	1400 lm	3073 lm	1865 lm

## OPTIC / OTTICHE

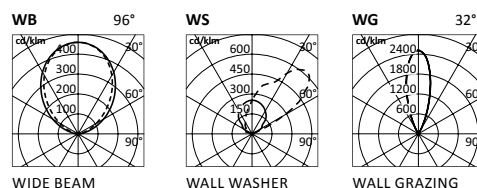

## PRODUCT CODES / CODICI PRODOTTO

**D 4 9 / 1 - L W N - W S - A L**

PRODUCT PRODOTTO	SIZE DIMENSIONI	LIGHTING COLORS COLORI DELLA LUCE	OPTICS OTTICHE	CONTROLS CONTROLLI	FINISH FINITURE
D49 = MASTER	1 = L: 365mm - 12W 2 = L: 650mm - 20W 3 = L: 940mm - 28W 4 = L: 1230mm - 37W	LWN = 4000K CRI>80 LWLW = 3000K CRI>80 RGBW*	WB: Wide beam Fascio diffuso WS: Wall washer WG: Wall grazing Fascio stretto	Standard ON-OFF add/aggiungere DD = DALI	AL = ALUMINIUM GREY GR = GRAPHITE

\*Only for size 2-3-4 and only for WG optic/ Solo per dimensione 2-3-4 e solo per ottica WG

To be order separately: rough-in housing / Da ordinare separatamente: casseforme.



TELLUX SMALL 00  | IP68  
-1m | IK10 | CE

TELLUX SMALL 01  | IP66  
IP67 | IK08 | CE

TELLUX SMALL 1  | IP66  
IP67 | IK10 | CE



## ENVIRONMENTS

Urban landscape, façades and architectural works, hallway, residential lighting.

## PHYSICAL FEATURES

Body: Corrosion resistant anodized aluminium body.

High impact resistant composite technopolymer housing box.  
AISI 316 stainless steel frame sandblasted.

Diffuser: Extra clear tempered glass

Screws: AISI 304 stainless steel screws

Seals: Silicone Rubber

## ELECTRICAL FEATURES

Driver: Integral ON-OFF

Remote ON-OFF or DALI only for 00

Voltage: 220-240V

12-24V-DC only for 00

Frequency: 50-60Hz

Wiring: Pre-wired and tested with resin sealed watertight

## SOURCES

LED 4000K CRI>80 - 3000K CRI>80

MacAdam: Step 3

Lifetime: 60.000h L90B10 (Ta=25°C)

## PERFORMANCE

Up to: 98 lm/W

## CONTESTI

Aree urbane/verdi, facciate e architetture, spazi d'accesso, illuminazione residenziale.

## CARATTERISTICHE FISICHE

Corpo: in alluminio anodizzato, resistente alla corrosione.

Cassaforma in tecnopolimero composito ad alta resistenza.

Telaio in acciaio inox AISI 316 sabbato.

Diffusore: Vetro temperato extra chiaro

Viteria: Viteria inox AISI 304

Guarnizioni: Gomma ai siliconi

## CARATTERISTICHE ELETTRICHE

Driver: Integrato ON-OFF

Remoto o DALI solo per 00

Tensione: 220-240V

12-24V-DC solo per 00

Frequenza: 50-60Hz

Cablaggio: Completo di spezzone di cavo collaudato a tenuta

## SORGENTI

LED 4000K CRI>80 - 3000K CRI>80

MacAdam: Step 3

Durata: 60.000h L90B10 (Ta=25°C)

## PERFORMANCE

Fino a: 98 lm/W

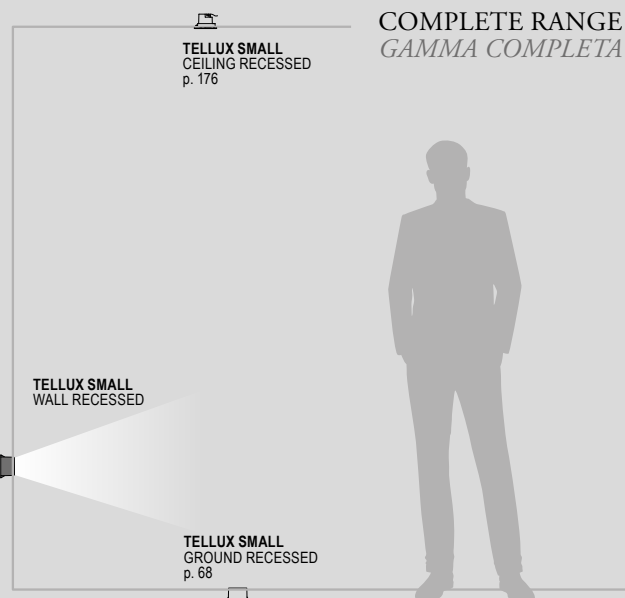



# TELLUX SMALL

## SIZE DIMENSIONI

## OPTIC OTTICHE

	T00		Q00		T01		Q01		T1		Q1	
Size	Ø 45 mm		45x45 mm		Ø 95 mm		95x95 mm		Ø 148 mm		148x148 mm	
Total system power	1 W		1 W		1 W		1 W		4 W		4 W	
Lumen output max	77 lm		77 lm		98 lm		98 lm		320 lm		320 lm	

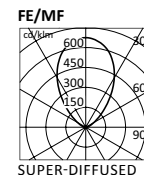

## PRODUCT CODES / CODICI PRODOTTO

**D 4 1 K / T 1 - L W N M F**

PRODUCT PRODOTTO	CLASS CLASSE	SHAPE FORMA	SIZE DIMENSIONI	LIGHTING COLORS COLORI DELLA LUCE	BEAMS FASCI
D41 = TELLUX SMALL wall recessed	K* = Class I	T = ROUND Q = SQUARE	00 = 45mm (1W) 01 = 95mm (1W) 1 = 148mm (4,4W)	LWN = 4000K CRI>80 LWW = 3000K CRI>80	FE or MF** = FULL EFFECT

\*Only for 01 and 1 versions/ Solo per versioni 01 e 1 \*\*For version 01 use FE. For versions 00 and 1 use MF/ Per la versione 01 usare FE. Per le versioni 00 e 1 usare MF  
Rough-in housing included/ Casseforme incluse





---

# THOR



WALL  
RECESSED



 IP65 | IK07 or IK08 |   

 VG |  VN |  MAL |  MGR

#### ENVIRONMENTS

Urban landscape, façades and architectural works, wellness, hallway, places of worship.

#### PHYSICAL FEATURES

Painting: Polyester powder coating, with a multi-process treatment against corrosion (pass the exposure to over 1500 hours in a saline mist environment). Only MAL versions.

Body: Corrosion resistant die-cast aluminium body (only 0-01)  
High impact resistant composite technopolymer body.

Diffuser: Extra clear tempered glass

Screws: AISI 304 stainless steel screws

Seals: Silicone Rubber

#### ELECTRICAL FEATURES

Driver: Integral ON-OFF or DALI (only 1-2)

Voltage: 220-240V

Frequency: 50-60Hz

Wiring: Prewired with H07RN-F cable (only 01).

Use only H07RN-F cable (only 0-1-2-3).

Predisposed for daisy chain wiring (only 1-2-3).

#### SOURCES

LED 4000K CRI>80 - 3000K CRI>80

MacAdam: Step3

Lifetime: 50.000h L80B50 (Ta=25°C)

#### PERFORMANCE

Up to: 54 lm/W

#### CONTESTI

Aree urbane/verdi, facciate e architetture, wellness, spazi d'accesso, luoghi di culto.

#### CARATTERISTICHE FISICHE

Verniciatura: A polveri poliesteri, previo pluritrattamenti contro la corrosione (supera il test di 1500 ore in nebbia salina). Solo per versioni MAL.

Corpo: in alluminio pressofuso, resistente alla corrosione (solo 0-01).

Corpo in tecnopolimero composito ad alta resistenza.

Diffusore: Vetro temperato extra chiaro

Viteria: Viteria inox AISI 304

Guarnizioni: Gomma ai siliconi

#### CARATTERISTICHE ELETTRICHE

Driver: Integrato ON-OFF o DALI (solo 1-2)

Tensione: 220-240V

Frequenza: 50-60Hz

Cablaggio: Precablato con cavo H07RN-F (solo 01).

Usare solo cavo H07RN-F (solo 0-1-2-3).

Predisposti per linea passante (solo 1-2-3).

#### SORGENTI

LED 4000K CRI>80 - 3000K CRI>80

MacAdam: Step3

Durata: 50.000h L80B50 (Ta=25°C)

#### PERFORMANCE

Fino a: 54 lm/W

#### OPTIONAL ACCESSORIES ACCESSORI OPZIONALI



Rough-in housing high stress resistance composite technopolymer. Cassaforma in tecnopolimero composito ad alta resistenza.



Wall bracketed installation. Supporto per montaggio sporgente a parete.



Folded stainless steel floor installation bracket. Supporto a colonna in acciaio pressopiegato.

#### FINISH FINITURE



**VG**  
Grey glass  
Vetro colore grigio



**VN**  
Black glass  
Vetro colore nero







**MAL**  
Aluminium grey (metal)  
Grigio alluminio (metal)

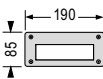

# THOR

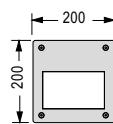
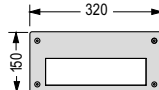
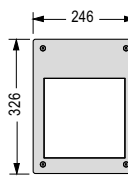
## SIZE / DIMENSIONI

					
	THOR/0	THOR/01	THOR/1	THOR/2	THOR/3
Total system power	6 W	3 W	8 W	10,5 W	22 W
Lumen output max	298 lm	108 lm	434 lm	572 lm	1198 lm

		
Total system power	3 W	3 W
Lumen output max	25 lm	20 lm

## OPTIC / OTTICHE

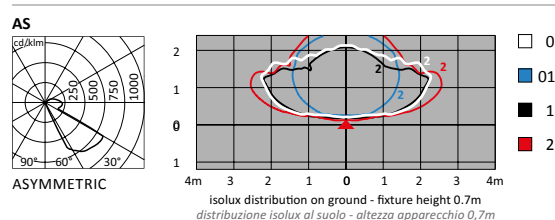

## PRODUCT CODES / CODICI PRODOTTO

# D 5 1 / 1 - M L W N - V G

PRODUCT PRODOTTO	SIZE DIMENSIONI	LIGHTING COLORS COLORI DELLA LUCE	FINISH FINITURE
D51 = THOR wall recessed	0 = 190x85mm 01 = 100x100mm 1 = 200x200mm 2 = 320x150mm 3 = 246x326mm	MLWN = 4000K CRI>80 DIFFUSED MLWW = 3000K CRI>80 DIFFUSED LWNLT* = 4000K CRI>80 LIGHTING BLADE LWHLT* = 3000K CRI>80 LIGHTING BLADE	VG** = GREY GLASS VN** = BLACK GLASS MAL = ALUMINIUM GREY (METAL) MGR = GRAPHITE SATIN FINISH (METAL)

\* Only for 0 and 01 versions/ Solo per versioni 0 e 01 \*\* Only for diffused versions/ Solo per versioni diffuse  
To be order separately: rough-in housing / Da ordinare separatamente: casseforme

# WALL SURFACE







IP65 | IK08 | C E

GR | DN

#### ENVIRONMENTS

Façades and architectural works, hallway, art and culture, places of worship.

#### PHYSICAL FEATURES

Body: Housing made of AISI 304 stainless steel brake-formed and fully TIG welded, powder-coated.

Diffuser: PC with surface treatment scratch-resistant and anti-aging UV rays.

Screws: AISI 304 stainless steel

#### ELECTRICAL FEATURES

Driver: Integral ON-OFF

Voltage: 220-240V

Frequency: 50-60Hz

Wiring: Use only (EN 60598-1) H07RN-F cable with diameter between 7,5 and 12mm.

#### SOURCES

LED 4000K CRI>80 3000K CRI>80

MacAdam: Step 2

Lifetime: 50.000h L80B10 (Ta=25°C)

#### PERFORMANCE

Up to: 112 lm/W

#### CONTESTI

Facciate e architetture, spazi d'accesso, arte e cultura, luoghi di culto.

#### CARATTERISTICHE FISICHE

Corpo: Struttura in lamiera di acciaio inox AISI 304 presso-piegata, elettrosaldata a TIG, verniciata a polvere.

Diffusore: PC con trattamento superficiale antigraffio e anti invecchiamento ai raggi UV.

Viteria: Viteria inox AISI 304

#### CARATTERISTICHE ELETTRICHE

Driver: integrato ON-OFF

Tensione: 220-240V

Frequenza: 50-60Hz

Cablaggio: Utilizzare solo (EN 60598-1) cavo tipo H07RN-F con diametro compreso tra 7,5 e 12mm.

#### SORGENTI

LED 4000K CRI>80 3000K CRI>80

MacAdam: Step 2

Durata: 50.000h L80B10 (Ta=25°C)

#### PERFORMANCE

Fino a: 112 lm/W

## OPTIONAL ACCESSORIES

### ACCESSORI OPZIONALI



Honeycomb anti-glare louver.

Griglia honeycomb abbagliamento.



Parallel grid.

Griglia parallela.

Accessories factory assembled. Please order with products.

Accessori montati in fabbrica.

Si prega di ordinarli in contemporanea con i prodotti.

## COMPLETE RANGE GAMMA COMPLETA

BOOK  
WALL SURFACE





# BOOK

## SIZE / DIMENSIONI

	<b>FLAT</b>	<b>SINK</b>
Total system power	15 W	21 W
Lumen output max	1684 lm	2242 lm

## OPTIC / OTTICHE

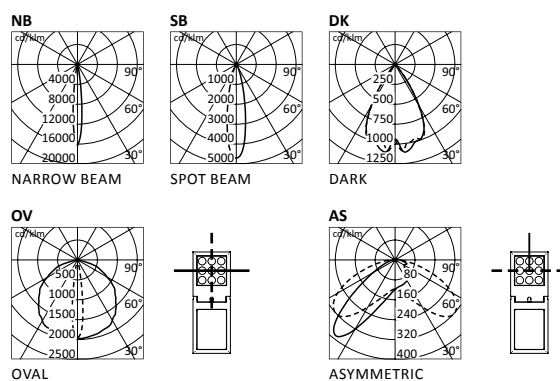

## REVERSIBLE EMISSION / EMISSIONE REVERSIBILE



The emission can be reversed due to the installation requirement.  
*L'emissione può essere ribaltata secondo le esigenze d'installazione.*

## INDOOR VERSION / VERSIONI



**Book IP20**  
Indoor catalogue  
*Catalogo interni*  
pag. 44

## PRODUCT CODES / CODICI PRODOTTO

# 1 0 0 1 - G R - 0 3 6 2

PRODUCT PRODOTTO	VERSIONS VERSIONI	FINISH FINITURE	LIGHTING COLORS & BEAMS COLORI DELLA LUCE & FASCI
10 = BOOK	01 = FLAT (15W) 02 = SINK (21W)	GR = GRAPHITE DN = WHITE	Please visit website <i>Visita il sito internet</i> example/ <i>esempio</i> : 0362 = 3000K CRI>80 Narrow beam





---

# BOX



WALL  
SURFACE

COMPLETE RANGE  
*GAMMA COMPLETA*

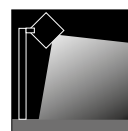

SPOTLIGHT  
p. 212



SPOTLIGHT  
p. 212

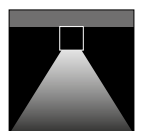

CEILING  
SURFACE  
p. 186



⊕ | IP65 | IK07 | CE | 

AL | GR

#### ENVIRONMENTS

Urban landscape, street lighting, façades and architectural works, industrial areas, places of worship.

#### PHYSICAL FEATURES

Painting: Polyester powder coating, with a multi-process treatment against corrosion (pass the exposure to over 1500 hours in a saline mist environment).

Body: Corrosion resistant die-cast aluminium body

Diffuser: Extra clear tempered glass

Screws: AISI 304 stainless steel screws

Seals: Silicone Rubber

#### ELECTRICAL FEATURES

Driver: Integral ON-OFF or DALI

Voltage: 220-240V

Frequency: 50-60Hz

Wiring: Use only (EN 60598-1) cable type H07RN-F with diameter between 7 and 10mm

#### SOURCES

LED 4000K CRI>80 3000K CRI>80

MacAdam: Step 3

Lifetime: 50.000h L80B20 (Ta=25°C)

#### PERFORMANCE

Up to: 58 lm/W

#### CONTESTI

Aree urbane/verdi, illuminazione stradale, facciate e architetture, wellness, spazi d'accesso, industria, luoghi di culto.

#### CARATTERISTICHE FISICHE

Verniciatura: a polveri poliesteri, previo pluritrattamenti contro la corrosione (supera il test di 1500 ore in nebbia salina).

Corpo: Corpo in alluminio pressofuso, resistente alla corrosione

Diffusore: Vetro temperato extra chiaro

Viteria: Viteria inox AISI 304

Guarnizioni: Gomma ai siliconi

#### CARATTERISTICHE ELETTRICHE

Driver: Integrato ON-OFF o DALI

Tensione: 220-240V

Frequenza: 50-60Hz

Cablaggio: Ingresso linea utilizzare solo (EN 60598-1) cavo tipo H07RN-F con diametro compreso tra 7 e 10mm

#### SORGENTI

LED 4000 CRI> 80 3000 CRI> 80

MacAdam: Step 3

Durata: 50.000h L80B20 (Ta=25°C)

#### PERFORMANCE

Fino a: 58 lm/W

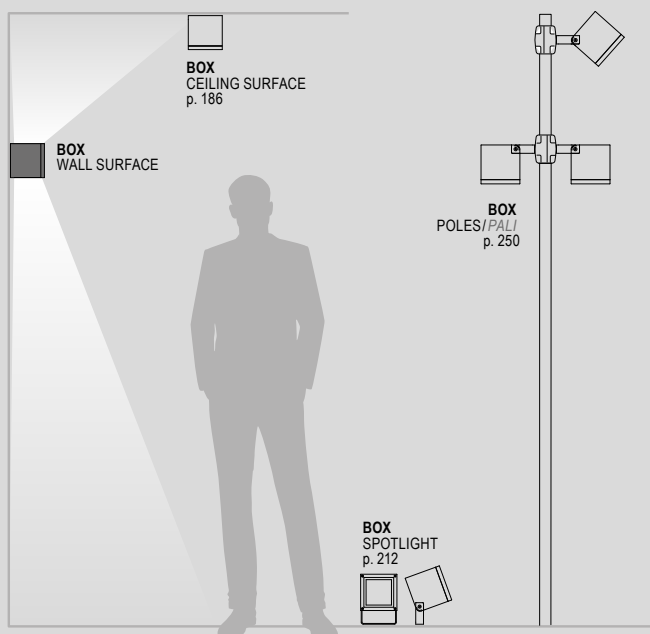



# BOX

## SIZE / DIMENSIONI

	BOX W0	BOX W1	BOX W2
Total system power max	6W	18,2W	28,3W
Lumen output max	286 lm	1052 lm	1065 lm

## BEAMS / FASCI

<b>B</b>  DIFFUSED	<b>MB**</b>  DIFFUSED	<b>Q</b>  DIFFUSED
<b>WB1</b>  DIFFUSED	<b>LT1*</b>  BLADE	<b>WB1 LT1*</b>  DIFFUSED+BLADE
<b>LT2*</b>  BLADE	<b>LT4*</b>  BLADE	

## PRODUCT CODES / CODICI PRODOTTO

**D 5 8 / W 0 - L W N B - A L**

PRODUCT PRODOTTO	SIZE DIMENSIONI	LIGHTING COLORS COLORI DELLA LUCE	BEAMS FASCI	CONTROLS CONTROLLI	FINISH FINITURE
D58 = BOX wall surface	W0 = 90x90mm W1 = 140x140mm W2 = 207x207mm	LWN = 4000K CRI>80 LWW = 3000K CRI>80	B = 2 DIFFUSED BEAM MB** = 1 DIFFUSED BEAM Q = 4 DIFFUSED BEAM WB1* = 1 DIFFUSED BEAM LT1* = 1 BLADE WB1LT1* = 1 DIFFUSED BEAM +1 BLADE LT2* = 2 BLADE LT4* = 4 BLADE	standard ON-OFF add/aggiungere DD-*** = DALI	AL = ALUMINIUM GREY GR = GRAPHITE

\*Only for W1/ Solo per W1    \*\*Only for W0/ Solo per W0    \*\*\*Only for W1 and W2 / Solo per W1 e W2







# CHIARO



WALL  
SURFACE

## COMPLETE RANGE *GAMMA COMPLETA*

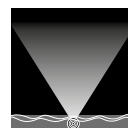

CHIARO Ø 30  
UNDERWATER  
p. 244



CHIARO Ø 30  
CEILING  
SURFACE  
p. 188



CHIARO Ø 60  
CEILING  
SURFACE  
p. 190



#### ENVIRONMENTS

Façades and architectural works, wellness, hallway, leisure areas, retail areas, industrial areas, places of worship.

#### PHYSICAL FEATURES

Body: End caps in AISI 316 stainless steel, tube in PC.  
Internal structure made of natural anodised extruded aluminium.

Diffuser: PC with anti-aging UV rays

Screws: AISI 316 stainless steel

Seals: Silicone Rubber

#### ELECTRICAL FEATURES

Driver: Remote ON-OFF or DALI

Voltage: 24V-DC

Wiring: Complete with pre-wired and tested watertight cable (L=2500mm).

#### SOURCES

LED 4000K CRI>80 3000K CRI>80

MacAdam: Step 3

Lifetime: 50.000h L80B50 (Ta=25°C)

#### PERFORMANCE

Up to: 103 lm/W

#### CONTESTI

Facciate e architetture, wellness, spazi d'accesso, intrattenimento, vendita e commercio, industria, luoghi di culto.

#### CARATTERISTICHE FISICHE

Corpo: Testate in inox AISI 316 e tubo in PC.

Struttura interna in estruso di alluminio anodizzato naturale.

Diffusore: PC con anti invecchiamento ai raggi UV

Viteria: Inox AISI 316

Guarnizioni: Gomma ai siliconi

#### CARATTERISTICHE ELETTRICHE

Driver: Remoto ON-OFF o DALI

Tensione: 24V-DC

Cablaggio: Completo di spezzone di cavo già collegato e collaudato a tenuta (L=2500mm).

#### SORGENTI

LED 4000K CRI>80 3000K CRI>80

MacAdam: Step 3

Durata: 50.000h L80B50 (Ta=25°C)

#### PERFORMANCE

Fino a: 103 lm/W

## POSSIBLE INSTALLATIONS

### POSSIBILITÀ D'INSTALLAZIONE



Pair of 316L AISI stainless steel brackets for distanced installation 50mm from ceiling/wall.

Coppia di staffe in acciaio INOX AISI 316L per fissaggio distanziata 50mm da plafone/parete.



Pair of 316L AISI stainless steel brackets for distanced installation 100mm from ceiling/wall.

Coppia di staffe in acciaio INOX AISI 316L per fissaggio distanziata 100mm da plafone/parete.



Pair of 316L AISI stainless steel brackets for ceiling/wall/floor installation (not walk-over).

Coppia di staffe in acciaio INOX AISI 316L per fissaggio a plafone/parete/terra (non calpestabile).

## OPTIC / OTTICHE

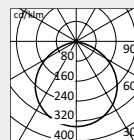

DIRECT



# CHIARO Ø30

## SIZE / DIMENSIONI

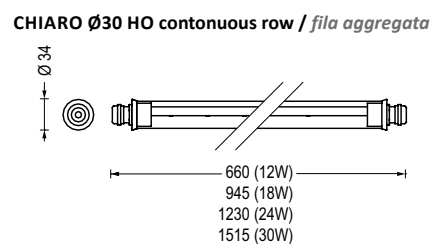
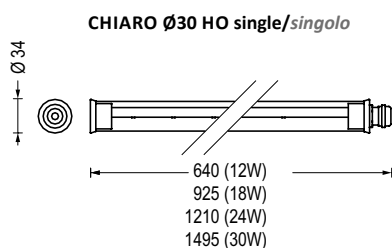

Total system power	10 W	15 W	20 W	25 W
Lumen output max	1026lm	1539lm	2052lm	2565lm

## CONFIGURATIONS / CONFIGURAZIONI

### CHIARO Ø30 Continuous row / Fila aggregata

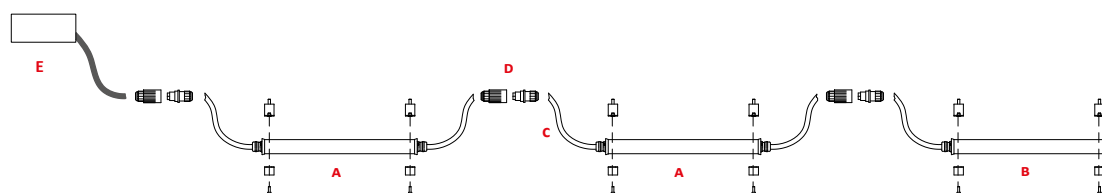

- A** CHIARO Continuous / Continuo
- B** CHIARO Single / Singolo

Included / incluso:

- C** CHIARO Continuous / Continuo  
2 cables / 2 cavi H05RN-F  
(L=2500mm)

- CHIARO Single / Singolo  
1 cables / 1 cavi H05RN-F  
(L=2500mm)

Not included / non inclusi:

- D** Connector / Connettore
- E** Remote driver / Driver remoto

## PRODUCT CODES / CODICI PRODOTTO

# 1 0 7 K F 1 2 2

PRODUCT PRODOTTO	TYOLOGY TIPOLOGIA	LIGHTING COLOR COLORI DELLA LUCE	LENGTHS LUNGHEZZE
107 = CHIARO	KF = SINGLE / SINGOLO KP = CONTINUOUS ROW/FILA AGGREGATA	10 = 4000K CRI>80 12 = 3000K CRI>80	2 = 640 or 660 mm (12W) 3 = 925 or 945 mm (18W) 4 = 1210 or 1230 mm (24W) 5 = 1495 or 1515 mm (30W)



⊕ | IP54 or IP66 | IK10 | CE | 

IS

#### ENVIRONMENTS

Façades and architectural works, wellness, hallway, leisure areas, retail areas, industrial areas, places of worship.

#### PHYSICAL FEATURES

Body: End caps in AISI 316 stainless steel, tube in PC.  
Internal structure made of natural anodised extruded aluminium.

Diffuser: PC with anti-aging UV rays

Screws: AISI 304 stainless steel

Seals: Silicone Rubber

#### ELECTRICAL FEATURES

Driver: Integral ON-OFF or DALI

Voltage: 220-240V

Frequency: 50-60Hz

Wiring: Complete with pre-wired and tested watertight cable (L=2500mm).

#### SOURCES

LED 4000K CRI>80 3000K CRI>80

MacAdam: Step 3

Lifetime: 50.000h L80B10 (Ta=25°C)

#### PERFORMANCE

Up to: 127lm/W

#### CONTESTI

Facciate e architetture, wellness, spazi d'accesso, intrattenimento, vendita e commercio, industria, luoghi di culto.

#### CARATTERISTICHE FISICHE

Corpo: Testate in inox AISI 316 e tubo in PC.

Struttura interna in estruso di alluminio anodizzato naturale.

Diffusore: PC con anti invecchiamento ai raggi UV

Viteria: inox AISI 304

Guarnizioni: Gomma ai siliconi.

#### CARATTERISTICHE ELETTRICHE

Driver: Integrato ON-OFF o DALI

Tensione: 220-240VC

Frequenza: 50-60Hz

Cablaggio: Completo di spezzone di cavo già collegato e collaudato a tenuta (L=2500mm).

#### SORGENTI

LED 4000K CRI>80 3000K CRI>80

MacAdam: Step 3

Durata: 50.000h L80B10 (Ta=25°C)

#### PERFORMANCE

Fino a: 127lm/W

### OPTIC / OTTICHE

Chiaro Ø60 is characterised by its transparent polycarbonate tube with co-extruded opaline section.

Chiaro Ø60 è caratterizzato da un tubo in policarbonato trasparente con porzione coestrusa opalina.

### POSSIBLE INSTALLATIONS

#### POSSIBILITÀ D'INSTALLAZIONE



Pair of 316L AISI stainless steel brackets for distanced installation 50mm from ceiling/wall.

Coppia di staffe in acciaio INOX AISI 316L per fissaggio distanziata 50mm da plafone/parete.



Pair of 316L AISI stainless steel brackets for distanced installation 100mm from ceiling/wall.

Coppia di staffe in acciaio INOX AISI 316L per fissaggio distanziata 100mm da plafone/parete.



Pair of 316L AISI stainless steel brackets for ceiling/wall/floor installation (not walk-over).

Coppia di staffe in acciaio INOX AISI 316L per fissaggio a plafone/parete/terra (non calpestabile).

#### TRANSPARENT / TRASPARENTE

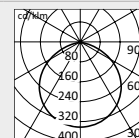

UGR T < 22  
UGR L < 23



Source in the transparent part of the tube.

Makes full use of the emitted flux.

Sorgente verso la parte trasparente del tubo.

Si sfrutta al massimo il flusso emesso.

#### OPAL / OPALE

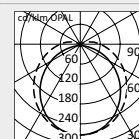

UGR T < 22  
UGR L < 23

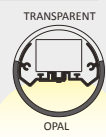

Source in the opaline part.

Creates a perfectly uniform light though the entire length of the tube.

Sorgente verso la parte opalina.

Si ottiene una luminosità perfettamente omogenea per tutta la lunghezza.



# CHIARO Ø60

## SIZE / DIMENSIONI

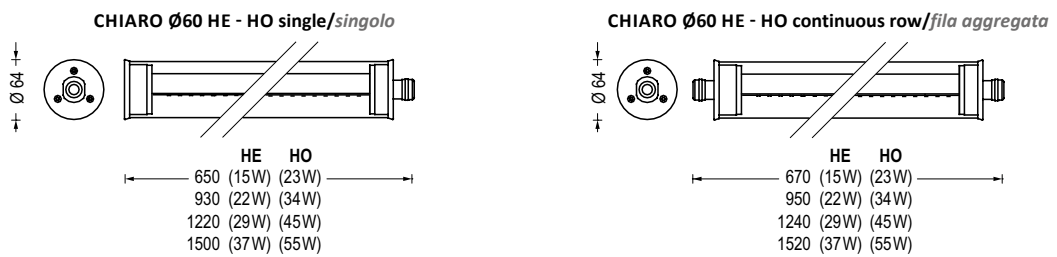

Versions	650/670 mm		930/950 mm		1220/1240 mm		1500/1520 mm	
Total system power	HE 15 W	HO 23 W	HE 22 W	HO 34 W	HE 29 W	HO 45 W	HE 37 W	HO 55 W
Lumen output max	1847 lm	2603 lm	2769 lm	3905 lm	3692 lm	5206 lm	4614 lm	6508 lm

## ACCESSORIES / ACCESSORI

### CHIARO Ø60 Continuous row / Fila aggregata

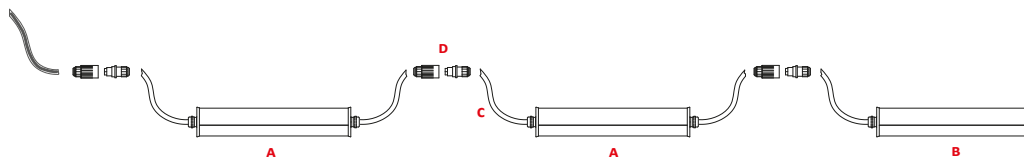

- A CHIARO Continuous / Continuo
- B CHIARO Single / Singolo

Included / incluso:

- C CHIARO Continuous / Continuo  
2 cables / 2 cavi H05RN-F  
(L=2500mm)

- CHIARO Single / Singolo  
1 cables / 1 cavi H05RN-F  
(L=2500mm)

Not included / non inclusi:  
D Connector / Connettore

## PRODUCT CODES / CODICI PRODOTTO

# T 1 0 7 P L 3 1 3



CONTROLS CONTROLLI	PRODUCT PRODOTTO	TIPOLOGY TIPOLOGIA	LENGTHS & LIGHTING COLORS LUNGHEZZE & COLORI DELLA LUCE
<p>T = ON-OFF</p> <p>DD = DALI</p> <p>1ET* = ON-OFF with 1h maintained emergency lighting kit</p>	107 = CHIARO	<p>PL = IP54 SINGLE / SINGOLO</p> <p>PM = IP54 CONTINUOUS ROW FILA AGGREGATA</p> <p>KL = IP66 SINGLE / SINGOLO</p> <p>KM = IP66 CONTINUOUS ROW FILA AGGREGATA</p>	<p>301 - 304 = HE - 4000K CRI&gt;80</p> <p>305 - 308 = HO - 4000K CRI&gt;80</p> <p>313 - 316 = HE - 3000K CRI&gt;80</p> <p>317 - 320 = HO - 3000K CRI&gt;80</p> <p>examples/esempi:</p> <p>301 = 15W 4000K CRI&gt;80</p> <p>302 = 22W 4000K CRI&gt;80</p> <p>305 = 23W 4000K CRI&gt;80</p> <p>306 = 34W 4000K CRI&gt;80</p>

\* Only for / Solo per L=1220 or L=1500



DUETTO/T1  IP65 | IK08 | CE

DUETTO/T2  IP66 | IK08 | CE 

#### ENVIRONMENTS

Façades and architectural works, hallway, conference hall, art and culture, leisure areas, places of worship, residential lighting.

#### PHYSICAL FEATURES

Painting: Polyester powder coating, with a multi-process treatment against corrosion (pass the exposure to over 1500 hours in a saline mist environment).

Body: Control gear box in die-cast, corrosion resistant, aluminium. Extruded aluminium cylinder.

Diffuser: Extra clear tempered glass

Screws: AISI 304 stainless steel screws

Seals: Silicone Rubber

#### ELECTRICAL FEATURES

Driver: Integral ON-OFF or DALI (only T2)

Voltage: 220-240V

Frequency: 50-60Hz

#### SOURCES

LED 4000K CRI>80 - 3000K CRI>80

MacAdam: Step 2

Lifetime: 60.000h L90B10 (Ta=25°C)

#### PERFORMANCE

Up to: 133 lm/W

#### CONTESTI

*Facciate e architetture, spazi d'accesso, sale conferenze, arte e cultura, intrattenimento, luoghi di culto, illuminazione residenziale.*

#### CARATTERISTICHE FISICHE

*Verniciatura: a polveri poliesteri, previo pluritrattamenti contro la corrosione (supera il test di 1500 ore in nebbia salina).*

*Corpo: Contenitore parti elettriche pressafuso in alluminio, resistente alla corrosione. Cilindro in alluminio estruso.*

*Diffusore: Vetro temperato extra chiaro*

*Viteria: Viteria inox AISI 304*

*Guarnizioni: Gomma ai siliconi*

#### CARATTERISTICHE ELETTRICHE

*Driver: Integrato ON-OFF o DALI (soloT2)*

*Tensione: 220-240V*

*Frequenza: 50-60Hz*

#### SORGENTI

*LED 4000K CRI>80 - 3000K CRI>80*

*MacAdam: Step 2*

*Durata: 60.000h L90B10 (Ta=25°C)*

#### PERFORMANCE

*Fino a: 133 lm/W*

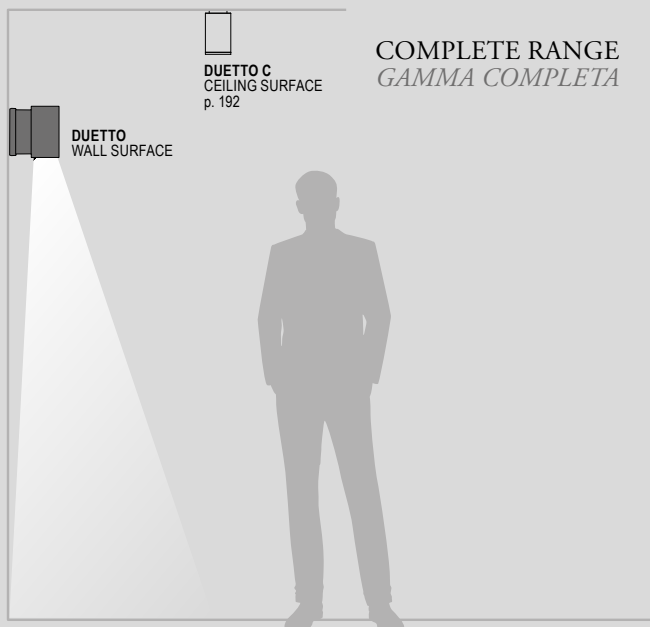

#### POSSIBLE INSTALLATIONS POSSIBILITÀ D'INSTALLAZIONE

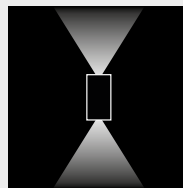

Wall mounted  
Parete

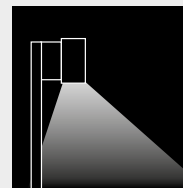

Pole mounted (T2)  
Applicazioni su palo (T2)



# DUETTO

## SIZE / DIMENSIONI

	DUETTO/T1 COB		DUETTO/T1 LW		DUETTO/T2	
	SINGLE	DOUBLE	SINGLE	DOUBLE	SINGLE	DOUBLE
Total system power	6 W	10 W	3,8 W	6 W	26 W	25,5 W
Lumen output max	800 lm	1322 lm	162 lm	325 lm	2948 lm	2874 lm
	<p>Architectural beam. <i>Fascio architettuale.</i></p>		<p>Decorative beam with optical system with plane convex lenses. <i>Fascio decorativo con sistema ottico a lenti piano convesse.</i></p>			

## OPTIC / OTTICHE

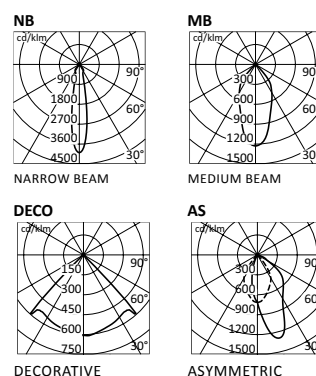

## PRODUCT CODES / CODICI PRODOTTO

**D 2 0 / T 1 - 8 4 H P - 1 N B - A L**

PRODUCT PRODOTTO	SIZE DIMENSIONI	LIGHTING COLORS COLORI DELLA LUCE	VERSIONS VERSIONI	BEAMS FASCI	CONTROLS CONTROLLI	FINISH FINITURE
D20 = DUETTO wall surface	T1 = Ø 70 x 182 mm T2 = Ø 140 x 265 mm	84 = 4000K CRI>80 83 = 3000K CRI>80 84HP* = 4000K CRI>80 83HP* = 3000K CRI>80	1 = SINGLE EMISSION 2 = DOUBLE EMISSIONS	NB = NARROW BEAM MB = MEDIUM BEAM AS** = ASYMMETRIC	standard ON-OFF add/aggiungere DD - *** = DALI	AL = ALUMINIUM GREY GR = GRAPHITE

\*HP=High power Only for Single emission versions/ Solo per versioni Mono emissione \*\*Only for T2 Single emission / Solo per T2 Mono emissione \*\*\*Only for T2 / Solo per T2  
For decorative codes please visit our website/ Per codici fascio decorativo visita il sito internet.



MICRODUPLO	⊕	IP65	IK07	CE	
MINIDUPLO	⊕	IP65	IK07	CE	halo
DUPLO	⊕	IP65	IK09	CE	halo

AL GR

## ENVIRONMENTS

Urban landscape, façades and architectural works, hallway.

## PHYSICAL FEATURES

Painting: Polyester powder coating, with a multi-process treatment against corrosion (pass the exposure to over 1500 hours in a saline mist environment).

Body: Corrosion resistant die-cast aluminium body

Diffuser: Extra clear tempered glass

Screws: AISI 304 stainless steel screws

Seals: Silicone Rubber

## ELECTRICAL FEATURES

Driver: Integral ON-OFF or DALI (only for MINIDUPLO-DUPLO)

Voltage: 220-240V

Frequency: 50-60Hz

Wiring: Use only (EN 60598-1) cable type H07RN-F

## SOURCES

LED 4000K CRI>80 - 3000K CRI>80

MacAdam: Step 3

Lifetime: 50.000h L80B20 (Ta=25°C)

## PERFORMANCE

Up to: 102 lm/W

## CONTESTI

Aree urbane/verdi, facciate e architetture, spazi d'accesso.

## CARATTERISTICHE FISICHE

Verniciatura: a polveri poliesteri, previo pluritrattamenti contro la corrosione (supera il test di 1500 ore in nebbia salina).

Corpo: Corpo in alluminio pressofuso, resistente alla corrosione

Diffusore: Vetro temperato extra chiaro

Viteria: Viteria inox AISI 304

Guarnizioni: Gomma ai siliconi

## CARATTERISTICHE ELETTRICHE

Driver: integrato ON-OFF o DALI (solo per MINIDUPLO-DUPLO)

Tensione: 220-240V

Frequenza: 50-60Hz

Cablaggio: Utilizzare solo (EN 60598-1) cavo tipo H07RN-F

## SORGENTI

LED 4000K CRI>80 - 3000K CRI>80

MacAdam: Step 3

Durata: 50.000h L80B20 (Ta = 25 ° C)

## PERFORMANCE

Fino a: 102 lm/W

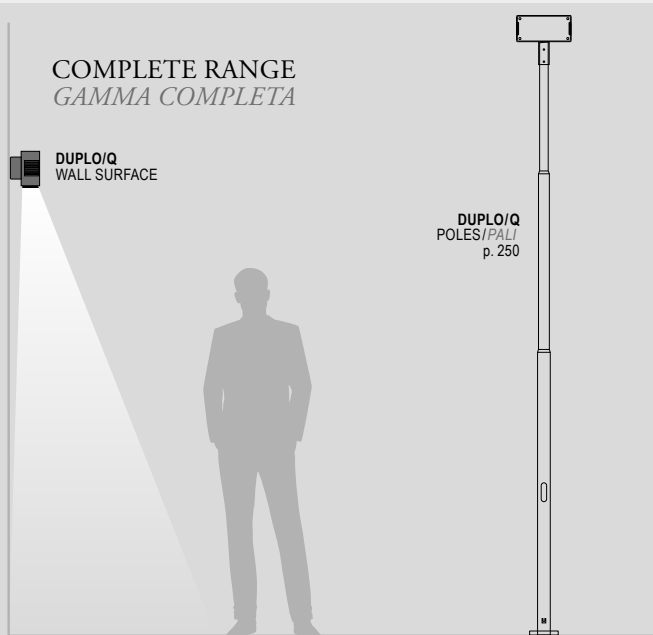

## POSSIBLE INSTALLATIONS

### POSSIBILITÀ D'INSTALLAZIONE

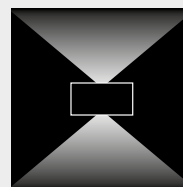

Wall mounted  
Parete

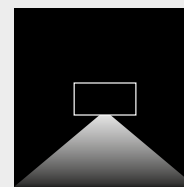

Pole mounted  
Applicazioni su palo

## OPTIONAL ACCESSORIES

### ACCESSORI OPZIONALI



For model/ Per modello  
**D60 Duplo/Q.**

Post top adapter Ø60mm.  
Raccordo per montaggio  
a palo Ø60mm.





# DUPLO/Q

## SIZE / DIMENSIONI

	MICRODUPLO/Q		MINIDUPLO/Q		DUPLO/Q	
	SINGLE	DOUBLE	SINGLE	DOUBLE	SINGLE	DOUBLE
Total system power	4,5 W	8,7 W	10 W	20 W	20W	40W
Lumen output max	404 lm	900 lm	1020 lm	2040 lm	2040 lm	4080 lm

## OPTIC / OTTICHE

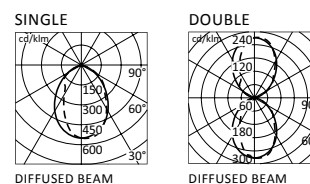

## PRODUCT CODES / CODICI PRODOTTO

# D 6 0 S / L W N - A L

PRODUCT PRODOTTO	VERSIONS VERSIONI	LIGHTING COLORS COLORI DELLA LUCE	CONTROLS CONTROLLI	FINISH FINITURE
D60S = MICRODUPLO/Q D60R = MINIDUPLO/Q D60 = DUPLO/Q	standard DOUBLE EMISSIONS add/aggiungere M/= SINGLE EMISSION	LWN = 4000K CRI>80 LWW = 3000K CRI>80	standard ON-OFF add/aggiungere DD-* = DALI	AL = ALUMINIUM GREY GR = GRAPHITE

\*Only for/ Solo per versioni MINIDUPLO/Q-DUPLO/Q



IP65 | IK09 | CE |

#### ENVIRONMENTS

Wellness, hallway, conference hall, art and culture, leisure areas, retail areas.

#### PHYSICAL FEATURES

Body: High performance polymer sheath.

#### ELECTRICAL FEATURES

Driver: Remote ON-OFF or DALI  
Voltage: 24V - DC

#### SOURCES

LED 4000K CRI>80 - 3000K CRI>80  
MacAdam: Step 3  
Lifetime: 50.000h L70B50 (Ta=25°C)

#### PERFORMANCE

Up to: 42 lm/W

#### CONTESTI

Wellness, spazi d'accesso, sale conferenze, arte e cultura, intrattenimento, vendita e commercio

#### CARATTERISTICHE FISICHE

Corpo: Guaina flessibile in polimero ad alte prestazioni.

#### CARATTERISTICHE ELETTRICHE

Driver: remoto ON-OFF o DALI  
Tensione: 24V - DC

#### SORGENTI

LED 4000K CRI>80 - 3000K CRI>80  
MacAdam: Step 3  
Durata: 50.000h L70B50 (Ta=25°C)

#### PERFORMANCE

Fino a: 42 lm/W

## BEYOND THE CATALOGUE

- IP67 at request / IP67 a richiesta
- Recessed mounting / Montaggio a incasso
- Custom lengths up to 5m / Lunghezze custom fino a 5m

## VERSION / VERSIONI

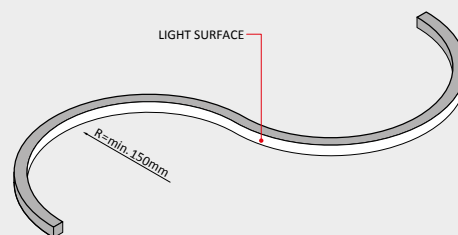

#### FILO FLEX Front bending

Straight lines on at or curved surfaces.  
Linee rettilinee su superfici piane e curve.

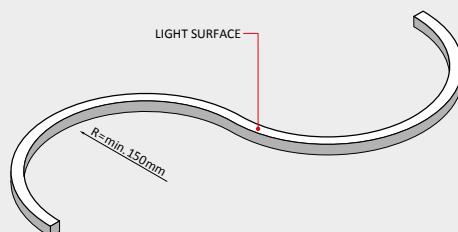

#### FILO FLEX Side bending

Straight and curved lines on at surfaces.  
Linee rettilinee e curve su superfici piane.



## COMPLETE RANGE GAMMA COMPLETA



# FILO FLEX

## SIZE / DIMENSIONI

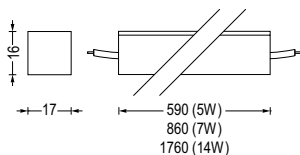

**FILO FLEX Front bending**

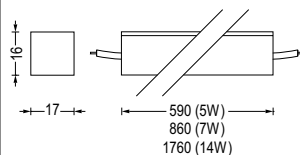

**FILO FLEX Side bending**

Total system power	15 W	15 W
Lumen output max	630 lm	496 lm

## OPTIC / OTTICHE

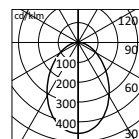

## PRODUCT CODES / CODICI PRODOTTO

# 1 0 8 D U 0 5 1

PRODUCT PRODOTTO	VERSIONS VERSIONI	LIGHTING COLORS COLORI DELLA LUCE	SIZE DIMENSIONI
<b>108DU</b> = FILO FLEX IP65	<b>0</b> = FRONT BENDING <b>2</b> = SIDE BENDING	<b>5</b> = 3000K CRI>80 <b>0</b> = 4000K CRI>80	<b>1</b> = 590mm <b>2</b> = 860mm <b>4</b> = 1760mm



### ENVIRONMENTS

Façades and architectural works, wellness, hallway, industrial areas.

### PHYSICAL FEATURES

Body: Natural anodised extruded aluminium structure.  
Die-cast aluminium end caps.  
Installation kit with harmonic steel springs.  
Diffuser: Extra clear tempered glass

### ELECTRICAL FEATURES

Driver: remote, ON-OFF or DALI  
Voltage: 21-25V-DC  
Wiring: Remote electrical harness wired for 220-240V-AC 50-60Hz, 24V-DC output (accessories to be ordered separately).  
Integrated through wiring.

### SOURCES

LED 4000K CRI>80 - 3000K CRI>80  
MacAdam: Step 3  
Lifetime: 70.000h L80B10 (Ta=25°C)

### PERFORMANCE

Up to: 61 lm/W  
Up to: 945 lm/m

### CONTESTI

Facciate e architetture, wellness, spazi d'accesso, industria.

### CARATTERISTICHE FISICHE

Corpo: Struttura in estruso di alluminio anodizzato naturale.  
Testate in pressofusione di alluminio.  
Kit di installazione con molle in acciaio armonico.  
Diffusore: Vetro temperato extra chiaro

### CARATTERISTICHE ELETTRICHE

Driver: Remoto, ON-OFF o DALI  
Tensione: 21-25V-DC  
Cablaggio: Elettrico con alimentatori remoti a 220-240V-AC 50-60Hz, uscita 24V-DC (accessori da ordinare separatamente).  
Cablaggio passante integrato.

### SORGENTI

LED 4000K CRI>80 - 3000K CRI>80  
MacAdam: Step 3  
Durata: 70.000h L80B10 (Ta=25°C)

### PERFORMANCE

Fino a: 61 lm/W  
Fino a: 945 lm/m

## OPTIONAL ACCESSORIES ACCESSORI OPZIONALI



Wall housing for single installation.  
Involucro parete installazione singola.



Wall housing for multiple aligned installation.  
Involucro parete installazione multipla in linea.



Pair of adjustable brackets 70mm long for wall housing.  
Coppia di staffe orientabili per involucro parete lunghezza 70mm



Pair of adjustable brackets 250mm long for wall housing.  
Coppia di staffe orientabili per involucro parete lunghezza 250mm



Pair of hold brackets for wall housing.  
Coppia di staffe fisse a scomparsa per involucro a parete.

ICE CEILING RECESSED  
p. 168

COMPLETE RANGE  
GAMMA COMPLETA

ICE WALL SURFACE

ICE WALL RECESSED  
p. 138

ICE GROUND RECESSED  
p. 54



# ICE

## SIZE / DIMENSIONI

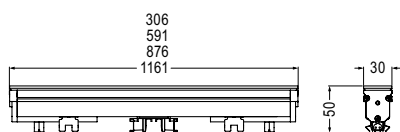

	306 mm	591 mm	876 mm	1161 mm
Total system power	4,5W	9W	13,5W	18W
Lumen output max	275 lm	548 lm	823 lm	1097 lm

## OPTIC / OTTICHE

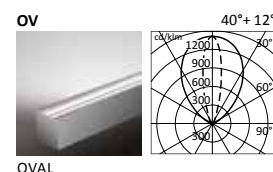
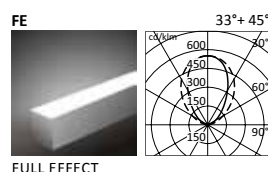

## HOW TO ORDER / COME ORDINARE

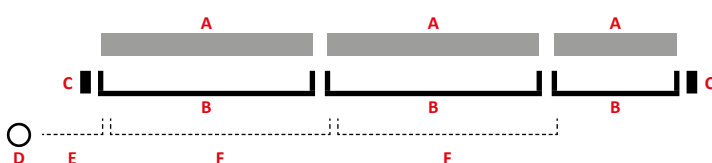

- A** Choose lighting modules / *Scegli i corpi illuminanti*
- B** Match the wall housing and brackets  
*Abbina gli involucri a parete e le staffe*
- C** Provide end caps (only for multiple installation)  
*Prevedi le testate di chiusura (solo per involucri multipli)*
- D** Choose drivers / *Scegli i driver*
- E** 1 starting cables for each drivers / *1 starting cable per ogni driver*
- F** Provide looping line (dimension in according to lighting modules lengths)  
*Looping cable (dimensione a seconda delle lunghezze dei prodotti)*

## PRODUCT CODES / CODICI PRODOTTO

# **D 6 4 / 3 - 0 3 - 1 L W W - F E**

PRODUCT PRODOTTO	SIZE DIMENSIONI	LIGHTING COLORS COLORI DELLA LUCE	OPTICS OTTICHE
D64 = ICE	3-03 = 306mm 3-06 = 591mm 3-09 = 876mm 3-12 = 1161mm	1 LWN = 4000K CRI80 1 LWW = 3000K CRI80	FE = Full effect OV = Oval

To be order separately: Wall housing, pair of brackets, end caps, stating cable, looping cable, driver.  
 Da ordinare separatamente: involucro parete, staffe, testate di chiusura, stating cable, looping cable, driver.





# KEA

DESIGN BY HABIT(S)

**ESSENTIAL LANGUAGE  
IN RESIDENTIAL DESIGN**  
*LINGUAGGIO ESSENZIALE IN  
DESIGN RESIDENZIALE*

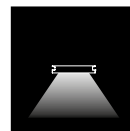

WALL SURFACE

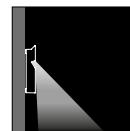

WALL SURFACE



WALL SURFACE

COMPLETE RANGE  
*GAMMA COMPLETA*

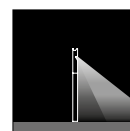

BOLLARD  
p. 86

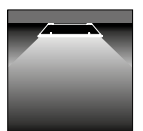

CEILING  
SURFACE  
p. 196



KEA FACADE  IP65 | IK07 | CE

KEA PATHWAY  IP65 | IK10 | CE 

GR | DN | AL | CO

#### ENVIRONMENTS

Façades and architectural works, hallway, residential lighting.

#### PHYSICAL FEATURES

Painting: Polyester powder coating, with a multi-process treatment against corrosion (pass the exposure to over 1500 hours in a saline mist environment).

Body: Corrosion resistant die-cast aluminium body

Diffuser: Extra clear tempered glass

#### ELECTRICAL FEATURES

Driver: Integral ON-OFF or DALI (only pathway)

Voltage: 220-240V

Frequency: 50-60Hz

Wiring: Predisposed for daisy chain wiring, internal derivation terminal block screws 3x2,5mm<sup>2</sup> use only (EN 60598-1) cable type H07RN-F with diameter between 7 and 10mm.

#### SOURCES

Sources: LED 3000K CRI>90 - 4000K CRI>80

MacAdam: Step 3

Lifetime: 70.000h L80B10 (Ta=25°C)

#### PERFORMANCE

Up to: 89 lm/W

#### CONTESTI

Facciate e architetture, spazi d'accesso, illuminazione residenziale.

#### CARATTERISTICHE FISICHE

Verniciatura: Verniciatura a polveri poliesteri, previo pluritrattamenti contro la corrosione (supera il test di 1500 ore in nebbia salina).

Corpo: in alluminio pressofuso, resistente alla corrosione

Diffusore: Vetro temperato extra chiaro

#### CARATTERISTICHE ELETTRICHE

Driver: Integrato ON-OFF o DALI (solo pathway)

Tensione: 220-240V

Frequenza: 50-60Hz

Cablaggio: Predisposti per linea passante, derivazione interna morsetto 3x2,5mm<sup>2</sup> utilizzare solo (EN 60598-1) cavo tipo H07RN-F con diametro compreso tra 7 e 10mm.

#### SORGENTI

Sorgenti: LED 3000K CRI>90 4000K CRI>80

MacAdam: Step 3

Durata: 70.000h L80B10 (Ta=25°C)

#### PERFORMANCE

Fino a: 89 lm/W

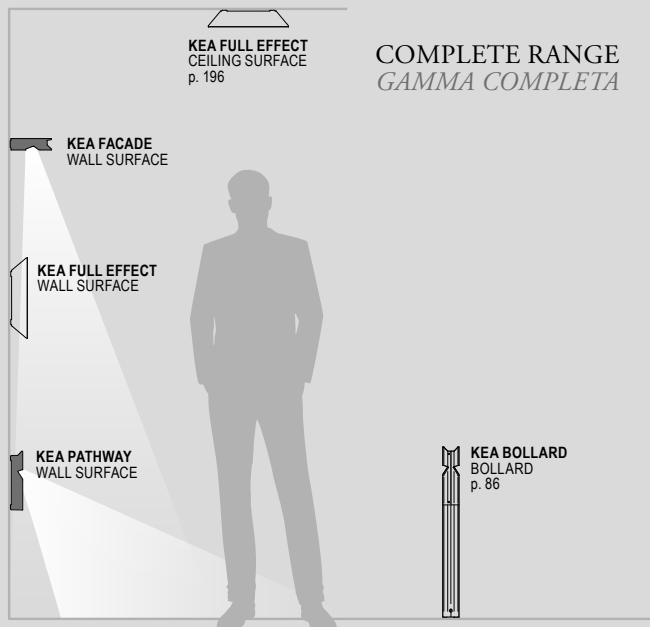

#### OPTIONAL ACCESSORIES

##### ACCESSORI OPZIONALI



#### KEA Pathway

Concrete rough-in housing.

Cassaforma incasso cemento.





FACADE



PATHWAY



# KEA FACADE - PATHWAY

DESIGN BY HABIT(S)

## SIZE / DIMENSIONI

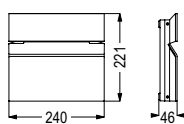
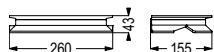

	KEA Facade		KEA Pathway	
	Single emission	Double emission	HP	
Total system power	10 W	16 W	9,5 W	17,5 W
Lumen output max	673 lm	1171 lm	380 lm	780 lm

## OPTIC / OTTICHE

FACADE - F1

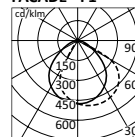

ASYMMETRIC

FACADE - F2

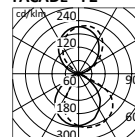

ASYMMETRIC

PATHWAY

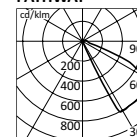

ASYMMETRIC

## PRODUCT CODES / CODICI PRODOTTO

# D 6 8 / F 1 - 8 4 - G R

PRODUCT PRODOTTO	VERSIONS VERSIONI	LIGHTING COLORS COLORI DELLA LUCE	CONTROLS CONTROLLI	FINISH FINITURE
D68 = KEA	F1 = Facade Single F2 = Facade Double P1 = Pathway	84 = 4000K CRI>80 93 = 3000K CRI>90 84HP* = 4000K CRI>80 93HP* = 3000K CRI>90	standard ON-OFF add/aggiungere DD -** = DALI	AL = ALUMINIUM GREY DN = EMBOSSED WHITE GR = GRAPHITE CO = CORTEN

\* Only for/ Solo per F1-P1 \*\* Only for/ Solo per P1





#### ENVIRONMENTS

Hallway, residential lighting.

#### PHYSICAL FEATURES

Painting: Polyester powder coating, with a multi-process treatment against corrosion (pass the exposure to over 1500 hours in a saline mist environment).

Body: Corrosion resistant die-cast aluminium body

Diffuser: Opal tempered glass

#### ELECTRICAL FEATURES

Driver: Integral ON-OFF or DALI

Voltage: 220-240V

Frequency: 50-60Hz

Wiring: Predisposed for daisy chain wiring, internal derivation terminal block screws 3x2,5mm<sup>2</sup> use only (EN 60598-1) cable type H07RN-F with diameter between 7 and 10mm.

#### SOURCES

Sources: LED 4000K CRI>80 3000K CRI>90

MacAdam: Step 3

Lifetime: 70.000h L80B10 (Ta=25°C)

#### PERFORMANCE

Up to: 65 lm/W

#### CONTESTI

Spazi d'accesso, illuminazione residenziale.

#### CARATTERISTICHE FISICHE

Verniciatura: a polveri poliesteri, previo pluritrattamenti contro la corrosione (supera il test di 1500 ore in nebbia salina).

Corpo: in alluminio pressofuso, resistente alla corrosione

#### CARATTERISTICHE ELETTRICHE

Driver: Integrato ON-OFF o DALI

Tensione: 220-240V

Frequenza: 50-60Hz

Cablaggio: Predisposti per linea passante, derivazione interna morsetto 3x2,5mm<sup>2</sup> utilizzare solo (EN 60598-1) cavo tipo H07RN-F con diametro compreso tra 7 e 10mm.

Diffusore: Vetro temperato opale

#### SORGENTI

Sorgenti: LED 4000K CRI>80 3000K CRI>90

MacAdam: Step 3

Durata: 70.000h L80B10 (Ta=25°C)

#### PERFORMANCE

Fino a: 65 lm/W

## EMERGENCY/EMERGENZA



Lighting effect in emergency mode.  
Effetto luminoso in funzionamento emergenza.

## OPTIONAL ACCESSORIES ACCESSORI OPZIONALI



**KEA Full effect**  
Concrete rough-in housing.  
Cassaforma in cassetto cemento.

## INDOOR VERSION VERSIONI INDOOR

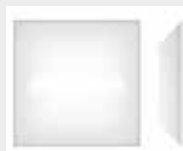

**KEA Full effect**  
Indoor catalogue  
Catalogo interni  
pag. 60

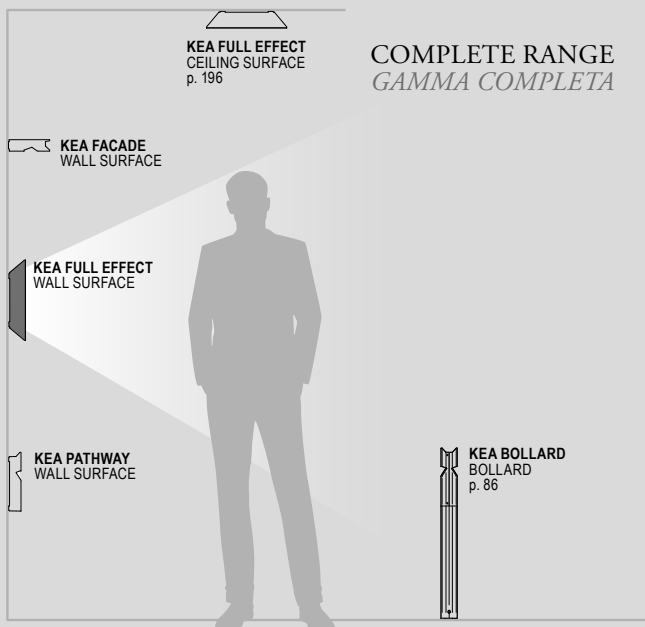

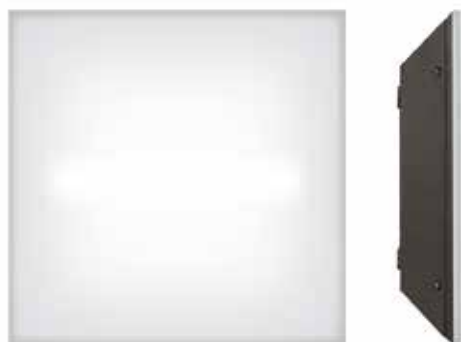

# KEA FULL EFFECT

DESIGN BY HABIT(S)

## SIZE / DIMENSIONI

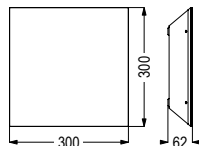

KEA Full effect

		Emergency with 230V	Emergency with battery
Total system power	24 W	19 W	7,5 W
Lumen output max	1390 lm	1230 lm	330 lm

## OPTIC / OTTICHE

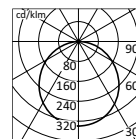

DIFFUSED

## PRODUCT CODES / CODICI PRODOTTO

**D 6 8 / E 1 - 8 4 - G R**

PRODUCT PRODOTTO	VERSIONS VERSIONI	LIGHTING COLORS COLORI DELLA LUCE	CONTROLS CONTROLLI	FINISH FINITURE
D68 = KEA	E1 = Full effect	84 = 4000K CRI>80 93 = 3000K CRI>90	standard ON-OFF add/aggiungere DD - = DALI standard NO EMERGENCY add/aggiungere 3E - = 3H EMERGENCY	AL = ALUMINIUM GREY DN = EMBOSSED WHITE GR = GRAPHITE CO = CORTEN



IP67 | IK10 | CE

AL | GR

#### ENVIRONMENTS

Urban landscape, façades and architectural works, hallway.

#### PHYSICAL FEATURES

Painting: Polyester powder coating, with a multi-process treatment against corrosion (pass the exposure to over 1500 hours in a saline mist environment).

Body: Composite high resistance technopolymer fixing base. Corrosion resistant die-cast aluminum body.

Diffuser: PC with anti-aging UV rays

Screws: AISI 304 stainless steel hardware tampering-proof

Seals: Silicone Rubber

#### ELECTRICAL FEATURES

Driver: Integral ON-OFF

Voltage: 220-240V

Frequency: 50-60Hz

Wiring: Complete with pre-wired and tested watertight H07RN-F cable.

#### SOURCES

LED COB 4000K CRI>80 - 3000K CRI>80

MacAdam: Step 3

Lifetime: 50.000h L80B20 (Ta=25°C)

#### PERFORMANCE

Up to: 45 lm/W

#### CONTESTI

Aree urbane/verdi, facciate e architetture, spazi d'accesso.

#### CARATTERISTICHE FISICHE

Verniciatura: a polveri poliesteri, previo pluritrattamenti contro la corrosione (supera il test di 1500 ore in nebbia salina).

Corpo: Base di fissaggio in tecnopolimero composito ad alta resistenza.

Corpo in alluminio pressofuso, resistente alla corrosione.

Diffusore: PC con anti invecchiamento ai raggi UV

Viteria: Inox AISI 304, antieffrazione

Guarnizioni: Gomma ai siliconi

#### CARATTERISTICHE ELETTRICHE

Driver: ON-OFF

Tensione: 220-240V

Frequenza: 50-60Hz

Cablaggio: Completo di spezzone di cavo H07RN-F già collegato e collaudato a tenuta

#### SORGENTI

LED COB 4000K CRI>80 - 3000K CRI>80

MacAdam: Step 3

Durata: 50.000h L80B20 (Ta = 25°C)

#### PERFORMANCE

Fino a: 45 lm/W

### COMPLETE RANGE GAMMA COMPLETA

MINIZACK  
WALL SURFACE



MINIZACK  
BOLLARD  
p. 90

ZACK  
BOLLARD  
p. 104



### OPTIONAL ACCESSORIES ACCESSORI OPZIONALI

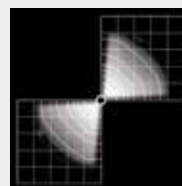

Darkening shield.  
Settore oscurante.



Opening key.  
Chiave di apertura  
apparecchio.



# MINIZACK

## SIZE / DIMENSIONI

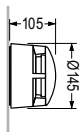

Total system power	6 W
Lumen output max	270 lm

## OPTIC / OTTICHE

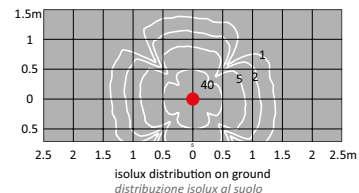
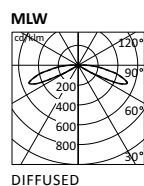

## PRODUCT CODES / CODICI PRODOTTO

# D 3 2 / M L W N - A L

PRODUCT PRODOTTO	LIGHTING COLORS COLORI DELLA LUCE	FINISH FINITURE
D32 = MINIZACK	MLWN = 4000K CRI>80 MLWW = 3000K CRI>80	AL = ALUMINIUM GREY GR = GRAPHITE



⊕ | IP65 | IK06 | CE

AL | GR

#### ENVIRONMENTS

Façades and architectural works, residential lighting.

#### PHYSICAL FEATURES

Painting: Powder coat painting after multi-layer polyester pre-treatment for corrosion resistance.  
 Body: Housing made of AISI 304 stainless steel brake-formed and fully TIG welded, powder-coated.  
 Diffuser: PC with surface treatment scratch-resistant and anti-aging UV rays.  
 Screws: AISI 304 stainless steel screws

#### ELECTRICAL FEATURES

Driver: Integral ON-OFF  
 Voltage: 220-240V  
 Frequency: 50-60Hz  
 Wiring: Use only (EN 60598-1) H07RN-F cable with diameter between 7,5 and 12mm.

#### SOURCES

LED 4000K CRI>80 - 3000K CRI>80  
 MacAdam: Step 3  
 Lifetime: 50.000h L80B10 (Ta=25°C)

#### PERFORMANCE

Up to: 111 lm/W

#### CONTESTI

Facciate e architetture, illuminazione residenziale.

#### CARATTERISTICHE FISICHE

Verniciatura: a polveri previo pre-trattamento con multistrato in poliestere ad alta resistenza alla corrosione.  
 Corpo: Struttura in lamiera di acciaio inox AISI 304 presso-piegata, elettrosaldata a TIG, verniciata a polvere.  
 Diffusore: PC con trattamento superficiale antigraffio e anti invecchiamento ai raggi UV.  
 Viteria: Inox AISI 304

#### CARATTERISTICHE ELETTRICHE

Driver: Integrato ON-OFF  
 Tensione: 220-240V  
 Frequenza: 50-60Hz  
 Cablaggio: Utilizzare solo (EN 60598-1) cavo tipo H07RN-F con diametro compreso tra 7,5 e 12mm.

#### SORGENTI

LED 4000K CRI>80 - 3000K CRI>80  
 MacAdam: Step 3  
 Durata: 50.000h L80B10 (Ta = 25 ° C)

#### PERFORMANCE

Fino a: 111 lm/W

### OPTICAL ACCESSORIES

#### ACCESSORI OTTICI

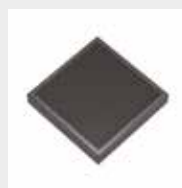

Honeycomb anti-glare louver.  
 Griglia honeycomb antiabbagliamento.



Parallel grid.  
 Griglia parallela.

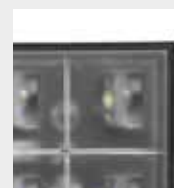

Internal louver for Wall washer optics.  
 Louver interno per ottica wall washer.

Accessories factory assembled. Please order with products.  
 Accessori montati in fabbrica.  
 Si prega di ordinarli in contemporanea con i prodotti.

### OPTIONAL ACCESSORIES

#### ACCESSORI OPZIONALI



Pole connection.  
 Suitable for one/two fixtures PLANO Facade F9.  
 Ganascia per montaggio a palo.  
 idonea per montaggio di uno/ due apparecchi PLANO Facade F9.

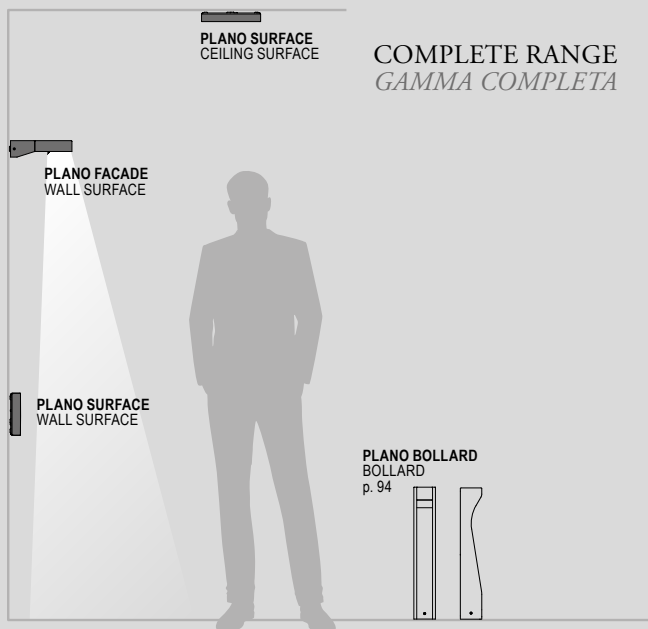



FACADE



SURFACE

# PLANO

## SIZE / DIMENSIONI

	<b>F4 - Surface</b>	<b>F4 - Facade</b>	<b>F9 - Surface</b>	<b>F9 - Facade</b>
Total system power	5W		11W	
Lumen output max	544 lm		1222 lm	

## OPTIC / OTTICHE

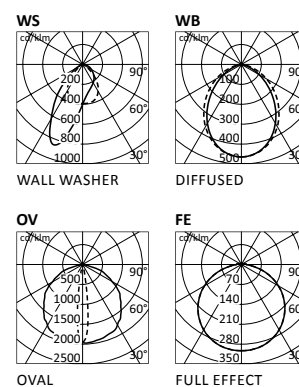

## BEAMS / FASCI

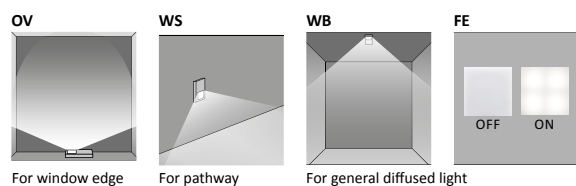

## PRODUCT CODES / CODICI PRODOTTO

# 2804 - GR - 0161

PRODUCT PRODOTTO	FINISH FINITURE	LIGHTING COLORS COLORI DELLA LUCE
2804 = PLANO Surface F4 2806 = PLANO Surface F9 2807 = PLANO Facade F4 2808 = PLANO Facade F9	AL = ALUMINIUM GREY GR = GRAPHITE	Please visit website Visita il sito internet example/eseempio: 0161 = 3000K CRI>80 OVAL



IP65 | IK09 | CE | 

AL | GR

#### ENVIRONMENTS

Façades and architectural works, wellness, hallway, retail areas, places of worship.

#### PHYSICAL FEATURES

Painting: Polyester powder coating, with a multi-process treatment against corrosion (pass the exposure to over 1500 hours in a saline mist environment).

Body: Corrosion resistant die-cast aluminium body

Diffuser: Extra clear tempered glass

Screws: AISI 304 stainless steel screws

Seals: Silicone Rubber

#### ELECTRICAL FEATURES

Driver: Integral ON-OFF or DALI

Voltage: 220-240V

Frequency: 50-60Hz

Wiring: Complete with pre-wired and tested watertight H07RN-F cable.

#### SOURCES

LED 4000K CRI>80 - 3000K CRI>80

MacAdam: Step 3

Lifetime: 50.000h L80B20 (Ta=25°C)

#### PERFORMANCE

Up to: 84 lm/W

#### CONTESTI

*facciate e architetture, wellness, spazi d'accesso, vendita e commercio, luoghi di culto.*

#### CARATTERISTICHE FISICHE

*Verniciatura: a polveri poliesteri, previo pluritrattamenti contro la corrosione (supera il test di 1500 ore in nebbia salina).*

*Corpo: Corpo in alluminio pressofuso, resistente alla corrosione*

*Diffusore: Vetro temperato extra chiaro*

*Viteria: Viteria inox AISI 304*

*Guarnizioni: Gomma ai siliconi*

#### CARATTERISTICHE ELETTRICHE

*Driver: integrato ON-OFF o DALI*

*Tensione: 220-240V*

*Frequenza: 50-60Hz*

*Cablaggio: Completo di spezzone di cavo H07RN-F già collegato e collaudato a tenuta.*

#### SORGENTI

LED 4000K CRI>80 - 3000K CRI>80

MacAdam: Step 3

Durata: 50.000h L80B20 (Ta=25°C)

#### PERFORMANCE

Fino a: 84 lm/W

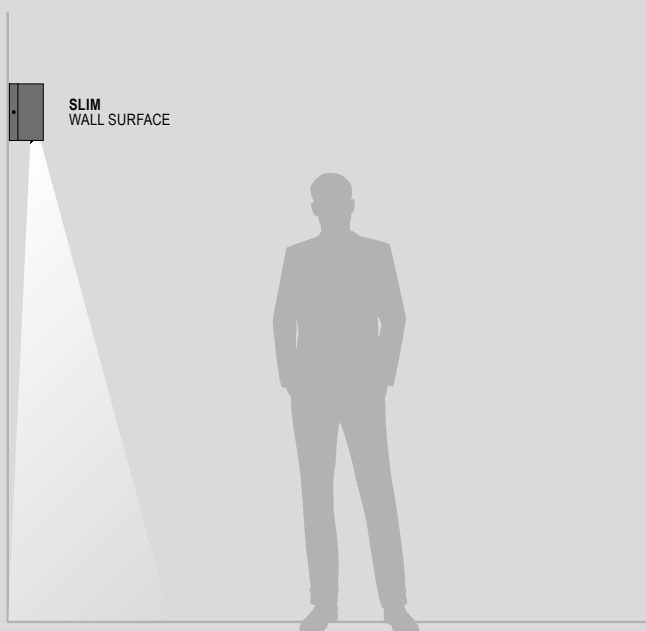





# SLIM

## SIZE / DIMENSIONI

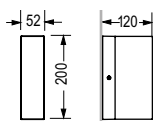

Total system power max 19,5W

Lumen output max 1294 lm

## OPTIC / OTTICHE

LWN WB1

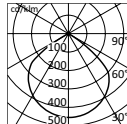

WIDE BEAM

LWN WB2

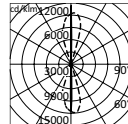

WIDE BEAM

LWN LT1 WB1

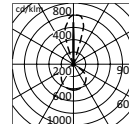

BLADE LIGHT +  
WIDE BEAM

LWN LT1

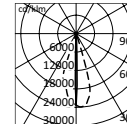

BLADE LIGHT

LWN LT2

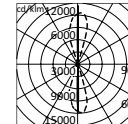

BLADE LIGHT

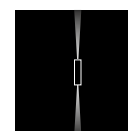
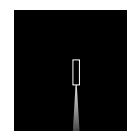
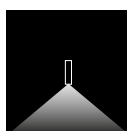

## PRODUCT CODES / CODICI PRODOTTO

# D 5 9 / L W N - W B 1 - R - A L

PRODUCT PRODOTTO	LIGHTING COLORS COLORI DELLA LUCE	BEAMS FASCI	VERSIONS VERSIONI	CONTROLS CONTROLLI	FINISH FINITURE
D59 = SLIM	LWN = 4000K CRI>80 LWW = 3000K CRI>80	WB1 = 1 WIDE BEAM WB2 = 2 WIDE BEAM WB1+LT1 = 1 WIDE BEAM + 1 BLADE LIGHT LT1 = 1 BLADE LIGHT LT2 = 2 BLADE LIGHT	standard HIGH POWER 11,5-19W add/aggiungere R-* = HIGH EFFICIENCY 6-10W	standard ON-OFF add/aggiungere DD-* = DALI	AL = ALUMINIUM GREY GR = GRAPHITE

\*Only for version/solo per versioni WB

\*\* Not available for LT2 version/Non disponibile per versione LT2



IP66 | IK06 | CE

AL GR

#### ENVIRONMENTS

Urban landscape, street lighting.

#### PHYSICAL FEATURES

Painting: Polyester powder coating, with a multi-process treatment against corrosion (pass the exposure to over 1500 hours in a saline mist environment).

Body: Housing made of extruded aluminium powder-coated. Die-Cast aluminum end caps painted in the same colour as the housing.

Diffuser: PC with surface treatment scratch-resistant and anti-aging UV rays.

Screws: AISI 304 stainless steel screws

#### ELECTRICAL FEATURES

Driver: Integral ON-OFF mains voltage spikes protection up to 4KV. Automatic night power reduction upon request.

Voltage: 220-240V

Frequency: 50-60Hz

Wiring: Use only (EN 60598-1) a two core H07RN-F rubber cable with diameter between 7,5 and 12mm.

#### SOURCES

LED 4000K CRI>80 - 3000K CRI>80

MacAdam: Step 2

Lifetime: 50.000h L80B10 (Ta=25°C)

#### PERFORMANCE

Up to: 92 lm/W

#### CONTESTI

Aree urbane/verdi, illuminazione stradale.

#### CARATTERISTICHE FISICHE

Verniciatura: a polveri poliesteri, previo pluritrattamenti contro la corrosione (supera il test di 1500 ore in nebbia salina).

Corpo: Struttura in estruso di alluminio verniciato a polvere. Testate in pressofusione di alluminio verniciato a polvere dello stesso colore della struttura.

Diffusore: PC con trattamento superficiale antigraffio e anti invecchiamento ai raggi UV.

Viteria: Viteria inox AISI 304

#### CARATTERISTICHE ELETTRICHE

Driver: integrato ON-OFF protezione contro le extra-tensioni di rete fino a 4KV. A richiesta con riduzione notturna automatica.

Tensione: 220-240V

Frequenza: 50-60Hz

Cablaggio: Utilizzare solo (EN 60598-1) cavo bipolare tipo H07RN-F con diametro compreso tra 7,5 e 12mm.

#### SORGENTI

LED 4000K CRI>80 - 3000K CRI>80

MacAdam: Step 2

Durata: 50.000h L80B10 (Ta=25°C)

#### PERFORMANCE

Fino a: 92 lm/W

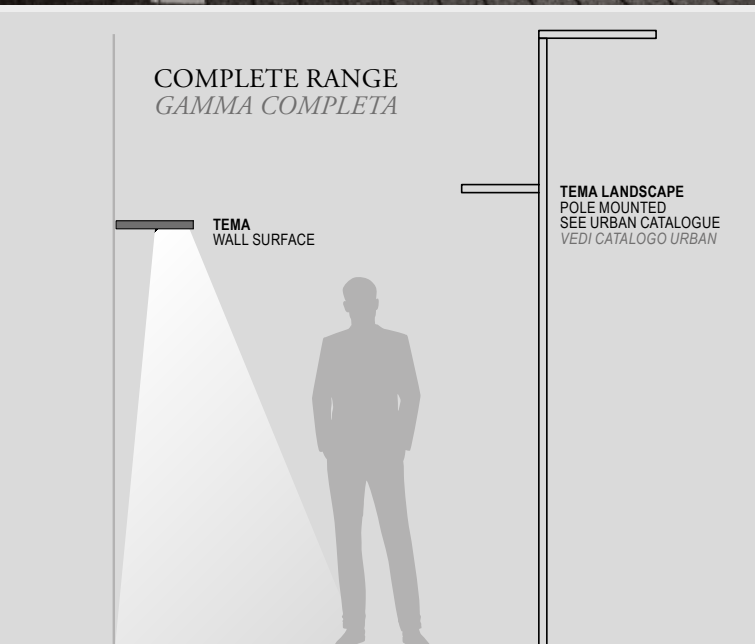

COMPLETE RANGE  
GAMMA COMPLETA

TEMA  
WALL SURFACE

TEMA LANDSCAPE  
POLE MOUNTED  
SEE URBAN CATALOGUE  
VEDI CATALOGO URBAN

#### BEYOND THE CATALOGUE

- DALI at request / DALI a richiesta
- Automatic midnight at request.  
Mezzanotte automatica a richiesta.

#### OPTIONAL ACCESSORIES ACCESSORI OPZIONALI



Adjustable fixing base  
± 15°.  
Base di fissaggio  
basculante ± 15°.



Parallel grid.  
Griglia parallela.  
Accessories factory  
assembled. Please order  
with products.  
Accessori montati in  
fabbrica. Si prega di  
ordinarli in contemporanea  
con i prodotti.



# TEMA CITY

DESIGN BY SARDELLINI MARASCA ARCHITETTI

## SIZE / DIMENSIONI

Total system power	43 W	83 W
Lumen output max	3818 lm	7636 lm

## OPTIC / OTTICHE

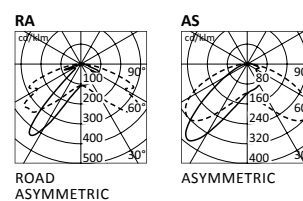

## PRODUCT CODES / CODICI PRODOTTO

# D 6 7 / C E 2 - L W N - 2 R A - G R

PRODUCT PRODOTTO	VERSION VERSIONE	LIGHTING COLORS COLORI DELLA LUCE	POWER POTENZA	BEAMS FASCI	FINISH FINITURE
D67 = TEMA	CE2 = CITY EASY CLASS II	LWN = 4000K CRI>80 LWW = 3000K CRI>80	2 = 43W 4 = 83W	RA = ROAD ASYMMETRIC AS = ASYMMETRIC	AL = ALUMINIUM GREY GR = GRAPHITE





# UPSTER

**POWERFUL FACADE FLOODLIGHT**  
*POTENTE PROIETTORE PER FACCIATE*

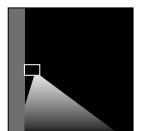

WALL  
SURFACE

Case history:  
Flags effect to the wall  
Effetto bandiera sulla parete



IP66 | IK06 | CE | 

GR | AL

## ENVIRONMENTS

Façades and architectural works, art and culture, places of worship, railway areas, subway areas.

## PHYSICAL FEATURES

Painting: Polyester powder coating, with a multi-process treatment against corrosion (pass the exposure to over 1500 hours in a saline mist environment).

Body: Corrosion resistant extruded aluminium body. Corrosion resistant die-cast aluminium end caps.

Diffuser: Extra clear tempered glass

Screws: AISI 304 stainless steel screws

Seals: Silicone Rubber

## ELECTRICAL FEATURES

Driver: Integral ON-OFF or DALI

Voltage: 220-240V

Frequency: 50-60Hz

Wiring: Complete with pre-wired and tested watertight H07RN-F cable.

## SOURCES

LED 4000K CRI>80 - 3000K CRI>80 or RGBW

MacAdam: Step 3

Lifetime: 70.000h L80B10 (Ta=25°C) (WG)

60.000h L80B10 (Ta=25°C) (FE)

## PERFORMANCE

Up to: 105 lm/W

## CONTESTI

Facciate e architetture, arte e cultura, luoghi di culto, aree ferroviarie, aree metropolitane.

## CARATTERISTICHE FISICHE

Verniciatura: a polveri poliesteri, previo pluritrattamenti contro la corrosione (supera il test di 1500 ore in nebbia salina).

Corpo: in alluminio estruso, resistente alla corrosione.

Testate di chiusura pressofuse in alluminio resistente alla corrosione.

Diffusore: Vetro temperato extra chiaro

Viteria: Viteria inox AISI 304

Guarnizioni: Gomma ai siliconi

## CARATTERISTICHE ELETTRICHE

Driver: Integrato ON-OFF o DALI

Tensione: 220-240V

Frequenza: 50-60Hz

Cablaggio: Completo di spezzone di cavo H07RN-F già collegato e collaudato a tenuta.

## SORGENTI

LED 4000K CRI>80 - 3000K CRI>80 o RGBW

MacAdam: Step 3

Durata: 70.000h L80B10 (Ta=25°C) (WG)

60.000h L80B10 (Ta=25°C) (FE)

## PERFORMANCE

Fino a: 105 lm/W

 UPSTER  
WALL SURFACE



## OPTIONAL ACCESSORIES

### ACCESSORI OPZIONALI



Pair of adjustable brackets L=120mm.  
Coppia di staffe orientabili L=120mm.



Adjustable double bracket L=120mm for continuous row, distance between products L=25mm.  
Staffa doppia orientabile per montaggio fila continua L=120mm, distanza tra i prodotti L=25mm.



# UPSTER

## SIZE / DIMENSIONI

### UPSTER WALL GRAZING



### UPSTER FULL EFFECT

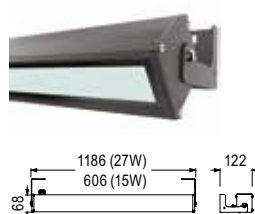

Versions	606 mm		1186 mm		606 mm	1186 mm
	WG	WG RGBW	WG	WG RGBW	FE	FE
Total system power	19W	30W	38W	57W	15W	27W
Lumen output max	1905 lm	933 lm	3810 lm	1865lm	905lm	1810lm

## OPTIC / OTTICHE

### WG

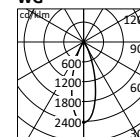

WALL GRAZING

### FE

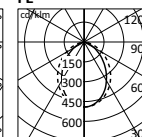

FULL EFFECT

### WGL

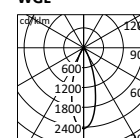

WALL GRAZING + LOUVER



## PRODUCT CODES / CODICI PRODOTTO

# D 6 9 / 2 - 8 4 H E - W G - G R

PRODUCT PRODOTTO	DIMENSIONI DIMENSIONI	LIGHTING COLORS & POWER COLORI DELLA LUCE & POTENZA	BEAMS FASCI	CONTROLS CONTROLLI	FINISH FINITURE
D69 = UPSTER	2 = 606 mm 4 = 1186 mm	84HE = 4000K CRI>80 HIGH EFFICIENCY 84HO = 3000K CRI>80 HIGH OUTPUT 83HE = 4000K CRI>80 HIGH EFFICIENCY 83HO = 3000K CRI>80 HIGH OUTPUT RGBW	WG = WALL GRAZING WGL = WALL GRAZING + LOUVER FE* = FULL EFFECT	standard ON-OFF add/aggiungere DD** = DALI	GR = GRAPHITE AL = ALUMINIUM GREY

\*Only for HE version / Solo per versioni HE

\*\*Only for / Solo per 3000K or 4000K

RGBW = DMX







---

# USEPARTOUT SUPERFLAT

DESIGN BY JOERG KREWINKEL

LIKE A LEAF ON THE WALL



WALL  
SURFACE



IP65 | IK08 | CE



**ENVIRONMENTS**

Urban landscape, wellness, hallway, residential lighting.

**PHYSICAL FEATURES**

Painting: Injection molded body in colored polymer blend  
 Body: Polycarbonate housing.  
 Snap-in latches built into the structure.

**ELECTRICAL FEATURES**

Driver: Integral ON-OFF  
 Voltage: 220-240V  
 Frequency: 50-60Hz  
 Wiring: Use only (EN 60598-1) a three core H07RN-F rubber cable with diameter between 7,5 and 12mm.

**SOURCES**

LED 4000K CRI>80 - 3000K CRI>80  
 MacAdam: Step 3  
 Lifetime: 70.000h L80B10 (Ta=25°C)

**PERFORMANCE**

Up to: 53 lm/W

**CONTESTI**

Aree urbane/verdi, wellness, spazi d'accesso, illuminazione residenziale.

**CARATTERISTICHE FISICHE**

Verniciatura: Corpo in tecnopolimero colorato stampato ad iniezione.  
 Corpo: Struttura in policarbonato.  
 Ganci di chiusura a scatto integrati nella struttura.

**CARATTERISTICHE ELETTRICHE**

Driver: integrato ON-OFF  
 Tensione: 220-240V  
 Frequenza: 50-60Hz  
 Cablaggio: Utilizzare solo (EN 60598-1) cavo tipo H07RN-F con diametro compreso tra 7,5 e 12mm.

**SORGENTI**

LED 4000K CRI>80 3000K CRI>80  
 MacAdam: Step 3  
 Lifetime: 70.000h L80B10 (Ta=25°C)

**PERFORMANCE**

Fino a: 53 lm/W

**COLOURS/COLORI**



Aluminium grey  
 Grigio alluminio

Graphite  
 satin finish  
 Grafite satinato

Corten\*

Embossed\*  
 white RAL 9003  
 Bianco gofrato

\* At request/ A richiesta

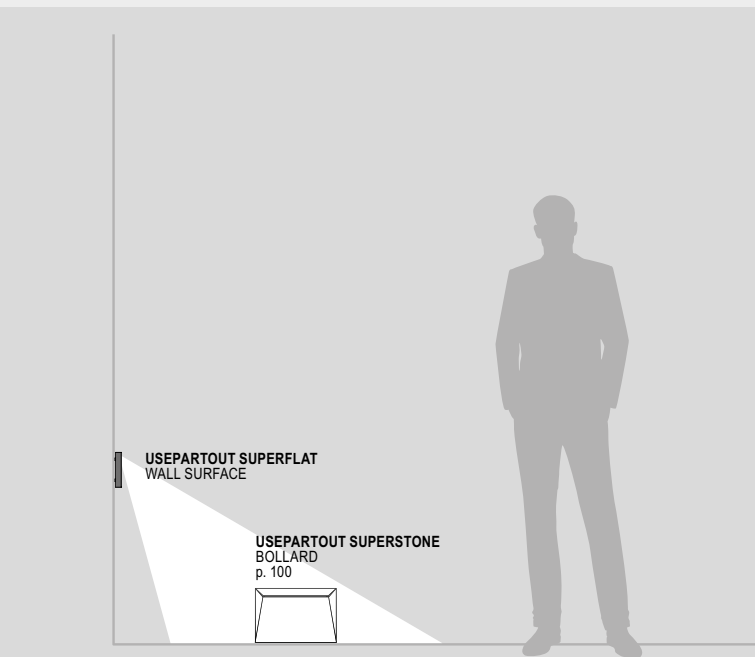

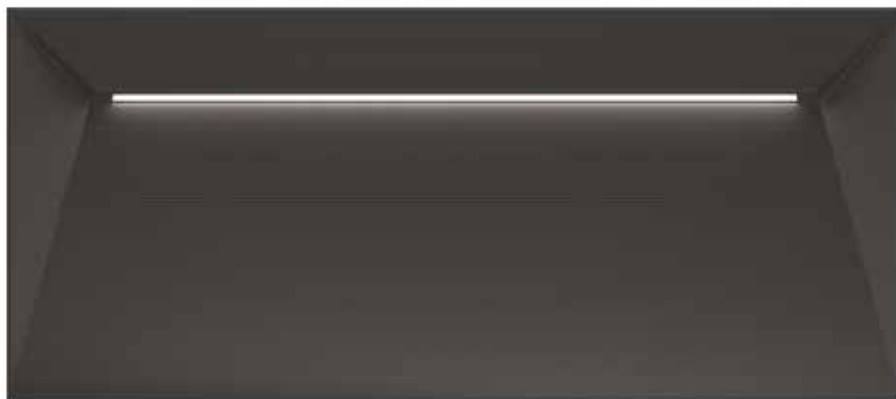

# USEPARTOUT SUPERFLAT

DESIGN BY JOERG KREWINKEL

## SIZE / DIMENSIONI

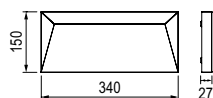

Total system power **9 W**  
Lumen output max **475 lm**

## OPTIC / OTTICHE

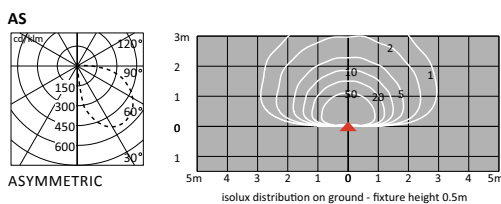

## INSTALLATION / INSTALLAZIONE



No housing box required  
IP65 driver integrated.  
*Non necessita di cassaforma  
IP65 driver integrato.*



No visible screw.  
*Nessuna vite a vista.*

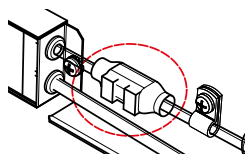

Internal wiring with waterproof  
connector included.  
*Cablaggio interno  
con connettori stagni inclusi.*

## PRODUCT CODES / CODICI PRODOTTO

# 4000 / EL83 - AL

PRODUCT PRODOTTO	CONTROLS CONTROLLI	LIGHTING COLORS COLORI DELLA LUCE	FINISH FINITURE
4000 = USEPARTOUT SUPERFLAT	EL = ON OFF	83 = 3000K CRI>80 84 = 4000K CRI>80	AL = ALUMINIUM GREY GR = GRAPHITE CO* = CORTEN DN* = EMBOSSED WHITE

\* At request / A richiesta



IP65 | IK08 | CE

GR CO

#### ENVIRONMENTS

Façades and architectural works, hallway, residential lighting.

#### PHYSICAL FEATURES

Painting: Polyester powder coating, with a multi-process treatment against corrosion (pass the exposure to over 1500 hours in a saline mist environment).

Body: Housing made of AISI 304 stainless steel brake-formed and fully TIG welded, powder-coated.

Diffuser: PC with surface treatment scratch-resistant and anti-aging UV rays.

Screws: AISI 304 stainless steel screws

#### ELECTRICAL FEATURES

Driver: ON-OFF

Voltage: 220-240V

Frequency: 50-60Hz

Wiring: Complete with pre-wired and tested watertight H07RN-F cable.

#### SOURCES

LED 4000K CRI>80 - 3000K CRI>80

MacAdam: Step 2

Lifetime: 50.000h L80B10 (Ta=25°C)

#### PERFORMANCE

Up to: 90 lm/W

#### CONTESTI

Facciate e architetture, spazi d'accesso, illuminazione residenziale.

#### CARATTERISTICHE FISICHE

Verniciatura: a polveri poliesteri, previo pluritrattamenti contro la corrosione (supera il test di 1500 ore in nebbia salina).

Corpo: Struttura in lamiera di acciaio inox AISI 304 presso-piegata, elettrosaldata a TIG, verniciata a polvere.

Diffusore: PC con trattamento superficiale antigraffio e anti invecchiamento ai raggi UV.

Viteria: Inox AISI 304

#### CARATTERISTICHE ELETTRICHE

Driver: ON-OFF

Tensione: 220-240V

Frequenza: 50-60Hz

Cablaggio: Completo di spezzone di cavo H07RN-F già collegato e collaudato a tenuta.

#### SORGENTI

LED 4000K CRI>80 - 3000K CRI>80

MacAdam: Step 2

Durata: 50.000h L80B10 (Ta=25°C)

#### PERFORMANCE

Fino a: 90 lm/W

### COMPLETE RANGE GAMMA COMPLETA

VERY APPLIQUE  
WALL SURFACE



VERY BOLLARD  
BOLLARD  
p. 102





# VERY APPLIQUE

DESIGN BY LUCHESEDESIGN

## SIZE / DIMENSIONI

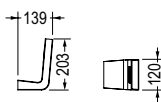

Total system power 6 W  
Lumen output max 540 lm

## OPTIC / OTTICHE

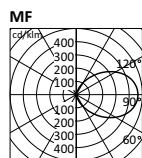

WIDE BEAM

## INSTALLATION / INSTALLAZIONE



Choose orientation / Scegli l'orientamento

## PRODUCT CODES / CODICI PRODOTTO

# 3 0 2 1 - G R - C 2 3 A

PRODUCT PRODOTTO	FINISH FINITURE	LIGHTING COLORS & BEAMS COLORI DELLA LUCE & FASCI
3021 = VERY applique	GR = GRAPHITE CO = CORTEN	C23A = 3000K CRI>80 diffused C24A = 4000K CRI>80 diffused

**CEILING RECESSED**





**ENVIRONMENTS**

Façades and architectural works, wellness, hallway, conference hall, art and culture, office, leisure areas, retail areas, study areas.

**PHYSICAL FEATURES**

Body: Die-cast light alloy body. "Easy Clip" fixing elements made of high resistance composite technopolymers.  
Diffuser: PC with surface treatment scratch-resistant and anti-aging UV rays.

**ELECTRICAL FEATURES**

Driver: ON-OFF or DALI  
Voltage: 220-240V  
Frequency: 50-60Hz

**SOURCES**

LED SQUARE 4000K CRI>90 - 3000K CRI>90  
MacAdam: Step 2  
Lifetime: 50.000h L80B10 (Ta=25°C)

**PERFORMANCE**

Up to: 80 lm/W

**CONTESTI**

*Facciate e architetture, wellness, spazi d'accesso, sale conferenze, arte e cultura, ufficio, intrattenimento, vendita e commercio, studio ed educazione.*

**CARATTERISTICHE FISICHE**

*Corpo: in alluminio pressofuso. Elementi di fissaggio "Easy Clip" in tecnopolimeri composti ad alta resistenza.  
Diffusore: PC con trattamento superficiale antigraffio e anti invecchiamento ai raggi UV.*

**CARATTERISTICHE ELETTRICHE**

*Driver: ON-OFF o DALI  
Tensione: 220-240V  
Frequenza: 50-60Hz*

**SORGENTI**

*LED SQUARE 4000K CRI>90 - 3000K CRI>90  
MacAdam: Step 2  
Durata: 50.000h L80B10 (Ta = 25 ° C)*

**PERFORMANCE**

*Fino a: 80 lm/W*

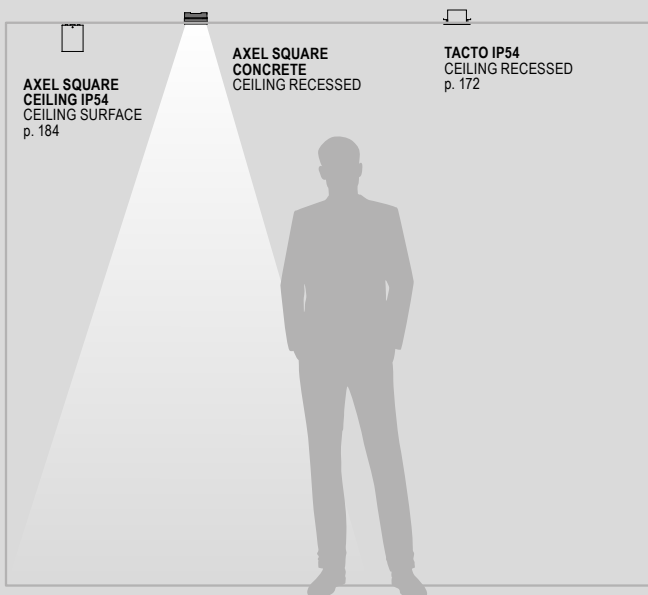

**INSTALLATION POSSIBILITY**

*POSSIBILITÀ D'INSTALLAZIONE*



Flush assembly  
*Assemblaggio a filo*



Projecting assembly  
*Assemblaggio sporgente*





# AXEL SQUARE CONCRETE

## SIZE / DIMENSIONI

	<b>OS4</b>	<b>OS9</b>
Total system power max	7 W	15 W
Lumen output max	540 lm	1201 lm

## OPTIC / OTTICHE

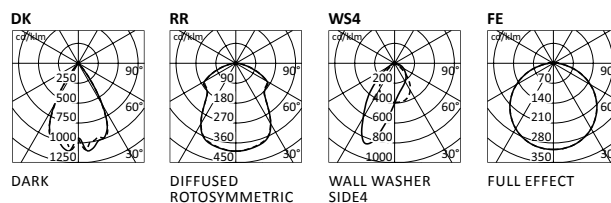

## PRODUCT CODES / CODICI PRODOTTO

# 2602 / BE - 9269 -

PRODUCT PRODOTTO	FINISH FINITURE	LIGHTING COLORS & BEAMS COLORI DELLA LUCE & FASCI	CONTROLS CONTROLLI
2602 = AXEL SQUARE CONCRETE S4 2604 = AXEL SQUARE CONCRETE S9	BE = black	Please visit website Visita il sito internet example/eseempio: 9269 = 3000K CRI>90 Dark	standard ON-OFF add/aggiungere DD* = DALI

\*Only for versions/ Solo per versioni S9

Rough-in housing to be ordered separately/Casseforme da ordinare separatamente.



IP67 | IK07 | CE | HALI

#### ENVIRONMENTS

Façades and architectural works, wellness, hallway, industrial areas.

#### PHYSICAL FEATURES

Body: Natural anodised extruded aluminium structure.  
Die-cast aluminium end caps.  
Installation kit with harmonic steel springs.  
Diffuser: Extra clear tempered glass

#### ELECTRICAL FEATURES

Driver: remote, ON-OFF or DALI  
Voltage: 21-25V-DC  
Wiring: Remote electrical harness wired for 220-240V-AC 50-60Hz, 24V-DC output (accessories to be ordered separately).  
Integrated through wiring.

#### SOURCES

LED 4000K CRI>80 - 3000K CRI>80  
MacAdam: Step 3  
Lifetime: 70.000h L80B10 (Ta=25°C)

#### PERFORMANCE

Up to: 61 lm/W  
Up to: 945 lm/m

#### CONTESTI

Facciate e architetture, wellness, spazi d'accesso, industria.

#### CARATTERISTICHE FISICHE

Corpo: Struttura in estruso di alluminio anodizzato naturale.  
Testate in pressofusione di alluminio.  
Kit di installazione con molle in acciaio armonico.  
Diffusore: Vetro temperato extra chiaro

#### CARATTERISTICHE ELETTRICHE

Driver: Remoto, ON-OFF o DALI  
Tensione: 21-25V-DC  
Cablaggio: Elettrico con alimentatori remoti a 220-240V-AC 50-60Hz, uscita 24V-DC (accessori da ordinare separatamente).  
Cablaggio passante integrato.

#### SORGENTI

LED 4000K CRI>80 - 3000K CRI>80  
MacAdam: Step 3  
Durata: 70.000h L80B10 (Ta=25°C)

#### PERFORMANCE

Fino a: 61 lm/W  
Fino a: 945 lm/m

## EASY AND FAST INSTALLATION

### INSTALLAZIONE FACILE E VELOCE



5 second IP67. Loop connection facility

Predisposizione per il collegamento loop - IP67 in 5 secondi

## OPTIONAL ACCESSORIES

### ACCESSORI OPZIONALI



Plasterboard rough-in housing.  
Cassaforma cartongesso.



Plasterboard rough-in housing corner 90° 2x306mm.  
Cassaforma cartongesso angolare 90° 2x306mm.



Pair of end caps for plasterboard rough-in housing.  
Coppia di testate di chiusura per cassaforma cartongesso.

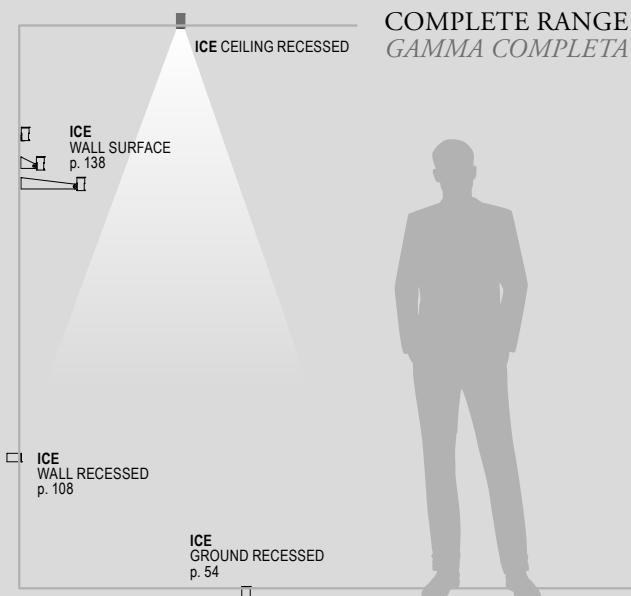



ICE

## SIZE / DIMENSIONI

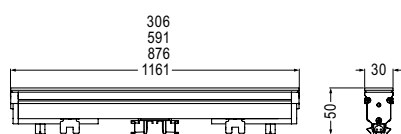

	306 mm	591 mm	876 mm	1161 mm
Total system power	4,5 W	9 W	13,5 W	18 W
Lumen output max	275 lm	548 lm	823 lm	1097 lm

## OPTIC / OTTICHE

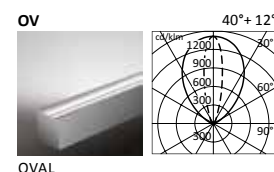
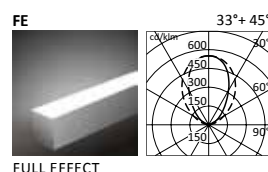

## HOW TO ORDER / COME ORDINARE

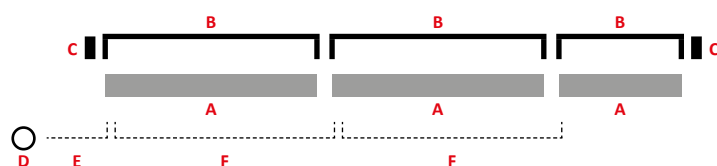

- A** Choose lighting modules /Scegli i corpi illuminanti
- B** Match the rough-in housing /Abbina le casseforme
- C** Provide end caps /Prevedi le testate di chiusura
- D** Choose drivers/Scegli i driver
- E** 1 starting cables for each drivers /1 starting cable per ogni driver
- F** Provide looping line (dimension in according to lighting modules lengths)  
Looping cable (dimensione a seconda delle lunghezze dei prodotti)

## PRODUCT CODES / CODICI PRODOTTO

**D 6 4 / 3 - 0 3 - 1 L W W - F E**

PRODUCT PRODOTTO	SIZE DIMENSIONI	LIGHTING COLORS COLORI DELLA LUCE	OPTICS OTTICHE
D64 = ICE	3-03 = 306 mm 3-06 = 591 mm 3-09 = 876 mm 3-12 = 1161 mm	1 LWN = 4000K CRI80 1 LWW = 3000K CRI80	FE = Full effect OV = Oval

To be order separately: Wall housing, pair of brackets, end caps, stating cable, looping cable, driver.  
Da ordinare separatamente: involucro parete, staffe, testate di chiusura, stating cable, looping cable, driver.



IP67 IK10 CE 

AL GR

#### ENVIRONMENTS

Façades and architectural works, hallway, industrial areas, railway areas, subway areas.

#### PHYSICAL FEATURES

Painting: Polyester powder coating, with a multi-process treatment against corrosion (pass the exposure to over 1500 hours in a saline mist environment).

Body: Corrosion resistant extruded aluminium body.  
Corrosion resistant die-cast aluminium end caps.

Diffuser: Extra clear tempered glass

#### ELECTRICAL FEATURES

Driver: Integral, ON-OFF or DALI

Voltage: 220-240V

Frequency: 50-60Hz

Wiring: Internal looping facility with two rubber cables

#### SOURCES

LED 4000K CRI>80 - 3000K CRI>80 - RGBW

MacAdam: Step 3

Durata: 50.000h L80B50 (Ta=25°C)

#### PERFORMANCE

Up to: 83 lm/W

#### CONTESTI

Facciate e architetture, spazi d'accesso, industria, aree ferroviarie, aree metropolitane.

#### CARATTERISTICHE FISICHE

Verniciatura: a polveri poliesteri, previo pluritrattamenti contro la corrosione (supera il test di 1500 ore in nebbia salina)

Corpo: in alluminio estruso, resistente alla corrosione.

Testate di chiusura pressofuse in alluminio resistente alla corrosione.

Diffusore: Vetro temperato extra chiaro

#### CARATTERISTICHE ELETTRICHE

Driver: Integrato, ON-OFF o DALI

Tensione: 220-240V

Frequenza: 50-60Hz

Cablaggio: Derivazione interna già predisposta con cavi in uscita

#### SORGENTI

LED 4000K CRI>80 - 3000K CRI>80 - RGBW

MacAdam: Step 3

Durata: 50.000h L80B50 (Ta=25°C)

#### PERFORMANCE

Fino a: 83 lm/W

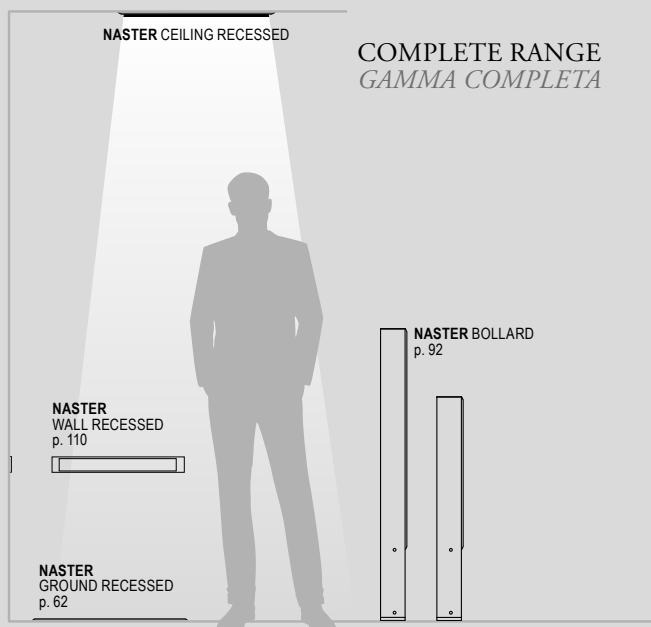

#### ACCESSORIES / ACCESSORI



Honeycomb louvre for Wall Grazing optic.

Honeycomb antiabbagliamento per ottica Wall Grazing.

Accessories factory assembled. Please order with products.

Accessori montati in fabbrica.

Si prega di ordinarli in contemporanea con i prodotti.



# MASTER

DESIGN BY EMANUELA PULVIRENTI

## SIZE / DIMENSIONI

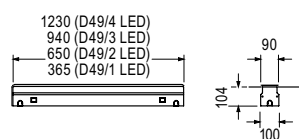

	365 mm	650 mm	650 mm	940 mm	940 mm	1230 mm	1230 mm
Total system power	12 W	20 W	30 W	28 W	44 W	37 W	57 W
Lumen output max	997 lm	1661 lm	933 lm	2326 lm	1400 lm	3073 lm	1865 lm

## OPTIC / OTTICHE

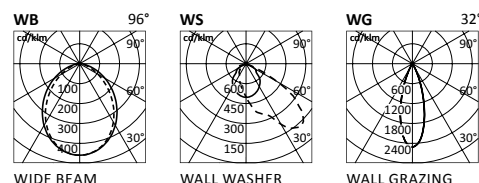

WIDE BEAM

WALL WASHER

WALL GRAZING

## PRODUCT CODES / CODICI PRODOTTO

**D 4 9 / C 1 - L W N - W S - A L**

PRODUCT PRODOTTO	SIZE DIMENSIONI	LIGHTING COLORS COLORI DELLA LUCE	OPTICS OTTICHE	CONTROLS CONTROLLI	FINISH FINITURE
D49 = MASTER	C1 = L: 365mm - 12W C2 = L: 650mm - 20W C3 = L: 940mm - 28W C4 = L: 1230mm - 37W	LWN = 4000K CRI>80 LWW = 3000K CRI>80 RGBW*	WB: WIDE BEAM WS: WALL WASHER WG: WALL GRAZING	Standard ON-OFF add/aggiungere DD - = DALI	AL = ALUMINIUM GREY GR = GRAPHITE

\* Only for size 2-3-4 and only for WG optic/ Solo per dimensione 2-3-4 e solo per ottica WG

False ceiling brackets included / Staffe per controsoffitto incluse





TACTO IP54



# TACTO IP54

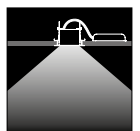

CEILING  
RECESSED



IP54 IK06 CE 

DN BE

#### ENVIRONMENTS

Wellness, hallway, conference hall, art and culture, office, leisure areas, retail areas, study areas.

#### PHYSICAL FEATURES

Painting: Powder painting after passivation  
 Body: Housing made of AISI 304 stainless steel brake-formed and fully TIG welded, powder-coated.  
 Diffuser: PC with surface treatment scratch-resistant and anti-aging UV rays.

#### ELECTRICAL FEATURES

Driver: Independent ON-OFF or DALI  
 Voltage: 220-240V  
 Frequency: 50-60Hz  
 Wiring: Pre-wired and tested with resin sealed watertight H07RN-F cable and connector IP68 ACS/CR1.

#### SOURCES

LED 4000K CRI>80 - 3000K CRI>80  
 MacAdam: Step 2  
 Lifetime: 50.000h L80B10 (Ta=25°C)

#### PERFORMANCE

Up to: 104 lm/W

#### CONTESTI

Wellness, spazi d'accesso, sale conferenze, arte e cultura, ufficio, intrattenimento, vendita e commercio, studio ed educazione.

#### CARATTERISTICHE FISICHE

Verniciatura: Verniciatura a polveri previa passivazione  
 Corpo: Struttura in lamiera di acciaio inox AISI 304 presso-piegata, elettrosaldata a TIG, verniciata a polvere.  
 Diffusore: PC con trattamento superficiale antigraffio e anti invecchiamento ai raggi UV.

#### CARATTERISTICHE ELETTRICHE

Driver: Separato ON-OFF o DALI  
 Tensione: 220-240V  
 Frequenza: 50-60Hz  
 Cablaggio: Completo di spezzone di cavo H07RN-F già collegato e collaudato a tenuta e connettore IP68 ACS/CR1.

#### SORGENTI

LED 4000K CRI>80 - 3000K CRI>80  
 MacAdam: Step 2  
 Durata: 50.000h L80B10 (Ta=25°C)

#### PERFORMANCE

Fino a: 104 lm/W

## OPTICAL ACCESSORIES

### ACCESSORI OTTICI

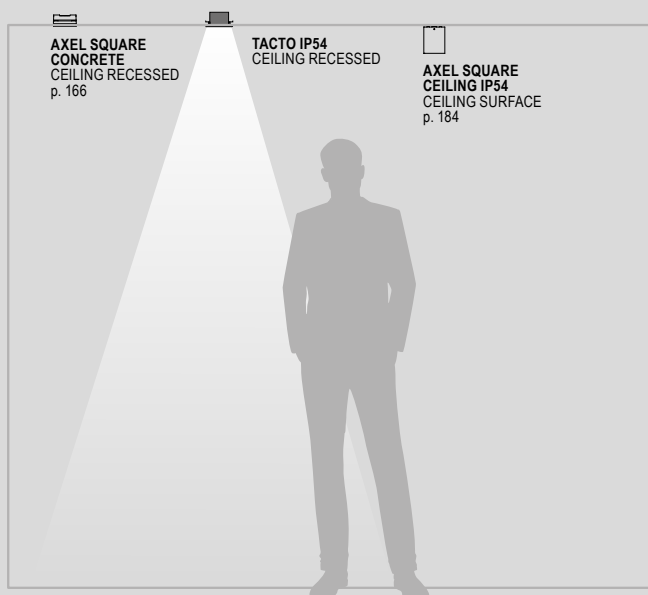

Honeycomb anti-glare louver.  
 Griglia honeycomb antiabbagliamento.



Parallel grid.  
 Griglia parallela.

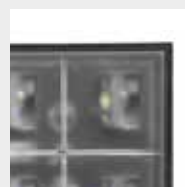

Internal louver for Wall washer optics (can be ordered only with products).  
 Louver interno per ottica Wall washer (è possibile ordinarlo solo in contemporanea con il prodotto).

Accessories factory assembled.  
 Please order with products.  
 Accessori montati in fabbrica.  
 Si prega di ordinarli in contemporanea con i prodotti.





# TACTO IP54

## SIZE / DIMENSIONI

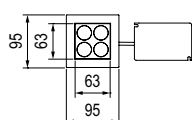
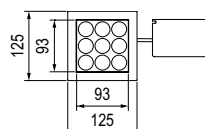
**TACTO S4 1x****TACTO S9 1x**

Total system power	10 W	21 W
Lumen output max	972 lm	2187 lm

## OPTIC / OTTICHE

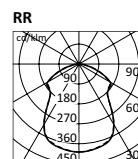
DIFFUSED  
ROTOSYMMETRIC

## PRODUCT CODES / CODICI PRODOTTO



# 2 1 2 4 - D N 0 0 1 3

PRODUCT PRODOTTO	VERSIONS VERSIONI	FINISH FINITURE	LIGHTING COLORS & BEAMS COLORI DELLA LUCE & FASCI
212 = TACTO IP54	4 = S4 ON OFF (10W) 5 = S4 DALI (10W) 6 = S9 ON OFF (21W) 7 = S9 DALI (21W)	DN = WHITE BE = BLACK	Please visit website Visita il sito internet example/esempio: 0013 = 3000K CRI>80 Diffused beam



TELLUX SMALL 00   

TELLUX SMALL 01   

TELLUX SMALL 1   



#### ENVIRONMENTS

Urban landscape, façades and architectural works, hallway, residential lighting.

#### PHYSICAL FEATURES

Body: Corrosion resistant anodized aluminium body.  
 High impact resistant composite technopolymer housing box.  
 AISI 316 stainless steel frame sandblasted.  
 Diffuser: Extra clear tempered glass  
 Screws: AISI 304 stainless steel screws  
 Seals: Silicone Rubber

#### ELECTRICAL FEATURES

Driver: Integral ON-OFF  
 Remote ON-OFF or DALI only for 00  
 Voltage: 220-240V  
 12-24V-DC only for 00  
 Frequency: 50-60Hz  
 Wiring: Pre-wired and tested with resin sealed watertight

#### SOURCES

LED 4000K CRI>80 - 3000K CRI>80  
 MacAdam: Step 3  
 Lifetime: 60.000h L90B10 (Ta=25°C)

#### PERFORMANCE

Up to: 98 lm/W

#### CONTESTI

Aree urbane/verdi, facciate e architetture, spazi d'accesso, illuminazione residenziale.

#### CARATTERISTICHE FISICHE

Corpo: in alluminio anodizzato, resistente alla corrosione.  
 Cassaforma in tecnopolimero composito ad alta resistenza.  
 Telaio in acciaio inox AISI 316 sabbato.  
 Diffusore: Vetro temperato extra chiaro  
 Viteria: Viteria inox AISI 304  
 Guarnizioni: Gomma ai siliconi

#### CARATTERISTICHE ELETTRICHE

Driver: Integrato ON-OFF  
 Remoto o DALI solo per 00  
 Tensione: 220-240V  
 12-24V-DC solo per 00  
 Frequenza: 50-60Hz  
 Cablaggio: Completo di spezzone di cavo collaudato a tenuta

#### SORGENTI

LED 4000K CRI>80 - 3000K CRI>80  
 MacAdam: Step 3  
 Durata: 60.000h L90B10 (Ta=25°C)

#### PERFORMANCE

Fino a: 98 lm/W

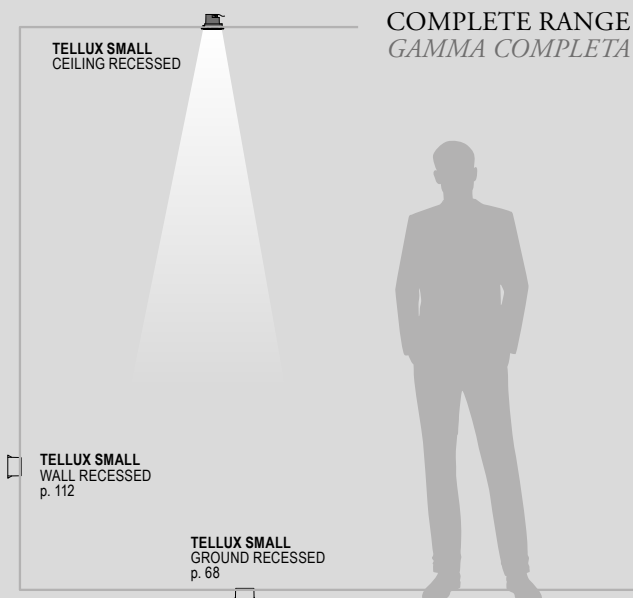



# TELLUX SMALL

## SIZE / DIMENSIONI

	<b>T00</b>	<b>Q00</b>	<b>T01</b>	<b>Q01</b>	<b>T1</b>	<b>Q1</b>	<b>T1 COB</b>	<b>Q1 COB</b>
Size	Ø45 mm	45 x 45 mm	Ø95 mm	95 x 95 mm	Ø148 mm	148 x 148 mm	Ø148 mm	148 x 148 mm
Total system power	1 W		1 W		4 W		6 W	
Lumen output max	77 lm		98 lm		320 lm		568 lm	

## OPTIC / OTTICHE

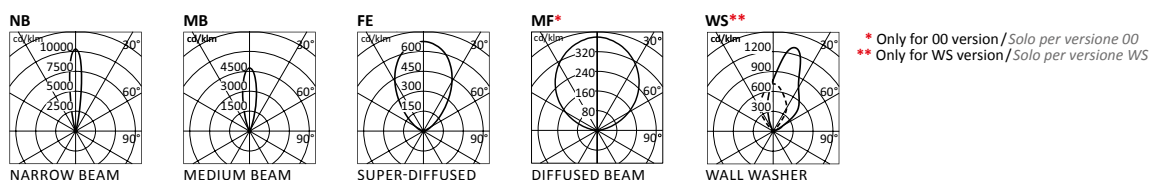

## PRODUCT CODES / CODICI PRODOTTO

**D 4 2 K / T 0 1 - 1 L W N - M B**

PRODUCT PRODOTTO	CLASS CLASSE	SHAPE FORMA	SIZE DIMENSIONI	VERSIONS VERISONI	LIGHTING COLORS COLORI DELLA LUCE	BEAMS FASCI
D42 = TELLUX SMALL ceiling recessed	K* = Class I	T = Round Q = Square	00 = 45 mm (1W) 01 = 95 mm (1W)	= T00 1 = T01	LWN = 4000K CRI>80 LWW = 3000K CRI>80	NB = NARROW BEAM MB* = MEDIUM BEAM MF** = DIFFUSED FE* = FULL EFFECT

\*Only for 01 versions / Solo per versioni 01    \*\*Only for 00 version / Solo per versione 00    Plasterboard brackets included / Staffe cartongesso include

**D 4 2 K / T 1 - 3 L W N - M B**

PRODUCT PRODOTTO	CLASS CLASSE	SHAPE FORMA	SIZE DIMENSIONI	VERSIONS VERISONI	LIGHTING COLORS COLORI DELLA LUCE	BEAMS FASCI
D42 = TELLUX SMALL ceiling recessed	K = Class I	T = Round Q = Square	1 = 148 mm	1 = COB 6W 3 = POWER LED 4,4W	LWN = 4000K CRI>80 LWW = 3000K CRI>80	NB = NARROW BEAM MB = MEDIUM BEAM FE = FULL EFFECT WS* = WALL WASHER

\*Only for COB version / Solo per versione COB    Plasterboard brackets included / Staffe cartongesso include



P66  
P67

IK10



IS

## ENVIRONMENTS

Urban landscape, façades and architectural works, hallway, residential lighting.

## PHYSICAL FEATURES

Body: corrosion resistant die-cast aluminium body.  
High impact resistant composite technopolymer housing box.  
AISI 316 stainless steel frame sandblasted.  
Diffuser: Extra clear tempered glass  
Screws: AISI 304 stainless steel screws  
Seals: Silicone Rubber

## ELECTRICAL FEATURES

Driver: Integral ON-OFF or DALI  
Voltage: 220-240V  
Frequency: 50-60Hz  
Wiring: Pre-wired and tested with resin sealed watertight

## SOURCES

LED 4000K CRI>80 - 3000K CRI>80  
MacAdam: Step 3  
Lifetime: 50.000h L80B10 (Ta=25°C)

## PERFORMANCE

Up to: 108 lm/W

## CONTESTI

Aree urbane/verdi, facciate e architetture, spazi d'accesso, illuminazione residenziale.

## CARATTERISTICHE FISICHE

Corpo: in alluminio pressofuso, resistente alla corrosione.  
Cassaforma in tecnopolimero composito ad alta resistenza.  
Telaio in acciaio inox AISI 316 sabbatiato.  
Diffusore: Vetro temperato extra chiaro  
Viteria: Viteria inox AISI 304  
Guarnizioni: Gomma ai siliconi

## CARATTERISTICHE ELETTRICHE

Driver: Integrato ON-OFF o DALI  
Tensione: 220-240V  
Frequenza: 50-60Hz  
Cablaggio: Completo di spezzone di cavo collaudato a tenuta

## SORGENTI

LED 4000K CRI>80 - 3000K CRI>80  
MacAdam: Step 3  
Durata: 50.000h L80B10 (Ta=25°C)

## PERFORMANCE

Fino a: 108 lm/W

## 2 PRODUCTS IN 1 / 2 PRODOTTI IN 1

### OPTICS



### FULL EFFECT



Optics (available in NB-SB-MB-EB-WB-WS beams) for power lighting.  
FULL EFFECT disc in Plexiglass edgelifighting for soft lighting and step light.

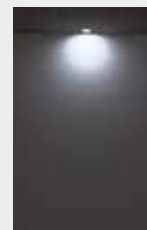

Switch between Optics or FULL EFFECT beam via DALI controller.

Ottico (disponibile in NB-SB-MB-EB-WB-WS) per illuminazione di potenza.  
Disco FULL EFFECT in Plexiglass edgelifighting per illuminazione soft e segnapasso.  
Cambia il fascio Ottico o FULL EFFECT utilizzando un controller DALI.

## OPTIONAL ACCESSORIES

### ACCESSORI OPZIONALI

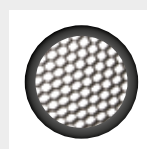

Optional honeycomb anti-glare louver (already included only for NB optic).  
Griglia honeycomb antiabbagliamento opzionale (già inclusa solo per ottica NB).

Accessories factory assembled.  
Please order with products.  
Accessori montati in fabbrica. Si prega di ordinarli in contemporanea con i prodotti.

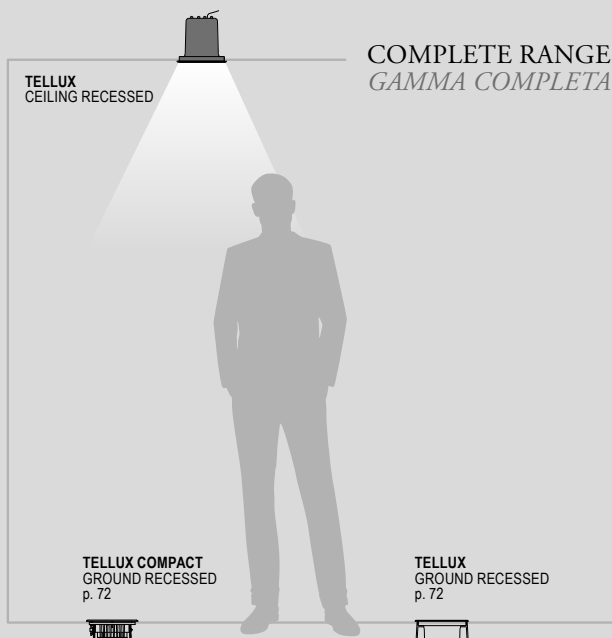



**VOLVENDO**  
ORBITAL AIMING  
ORIENTAMENTO ORBITALE



DUAL EFFECT AVAILABLE

**COB**  
FIXED OPTIC  
OTTICA FISSA



DUAL EFFECT AVAILABLE



# TELLUX

## SIZE / DIMENSIONI

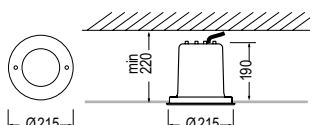
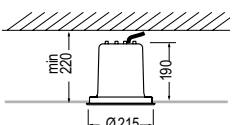
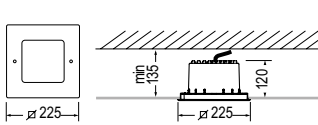
			
	<b>T2 VOLVENDO</b>	<b>T2 COB</b>	<b>Q2 VOLVENDO</b>
Size	<b>Ø 215 mm</b>		<b>225 x 225 mm</b>
Total system power max	13,5 W	28 W	10,6 W
Lumen output max	878 lm	3025 lm	831 lm

## OPTIC / OTTICHE

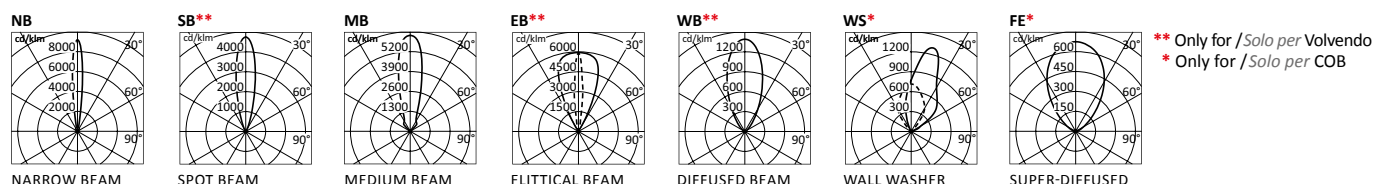

## PRODUCT CODES / CODICI PRODOTTO

**D 4 2 K / T 2 H P - 1 L W N - M B D - D D**

PRODUCT PRODOTTO	COB POWER POTENZA COB	LED	LIGHTING COLORS COLORI DELLA LUCE	BEAMS FASCI	DUAL EFFECT	CONTROLS CONTROLLI
<b>D42K/T2</b> = TELLUX /T2 ceiling recessed	Standard 13W <b>HP*</b> = High power 28W	1 = COB version fixed optic 5V = VOLVENDO POWER LED adjustable ±15°	<b>LWN</b> = 4000K CRI>80 <b>LWW</b> = 3000K CRI>80	<b>NB</b> = NARROW BEAM <b>SB**</b> = SPOT BEAM <b>MB</b> = MEDIUM BEAM <b>EB**</b> = ELLIPTICAL BEAM <b>WB**</b> = WIDE BEAM <b>WS*</b> = WALL WASHER <b>FE*</b> = SUPER DIFFUSED	<b>STANDARD</b> = CLEAR GLASS <b>D</b> = DUAL EFFECT VERSION  WB and FE not available in Dual Effect	Standard ON-OFF add/aggiungere <b>DD</b> = DALI

\*Only for COB versions/ Solo per versioni COB    \*\*Only for VOLVENDO versions/ Solo per versioni VOLVENDO    Plasterboard brackets included/ Staffe cartongesso incluse

**D 4 2 K / Q 2 - 5 V L W N - M B**

PRODUCT PRODOTTO	LED	LIGHTING COLORS COLORI DELLA LUCE	BEAMS FASCI	CONTROLS CONTROLLI
<b>D42K/Q2</b> = TELLUX /Q2 ceiling recessed	5V = VOLVENDO POWER LED 10.6W	<b>LWN</b> = 4000K CRI>80 <b>LWW</b> = 3000K CRI>80	<b>NB</b> = NARROW BEAM <b>SB</b> = SPOT BEAM <b>MB</b> = MEDIUM BEAM <b>EB</b> = ELLIPTICAL BEAM <b>WB</b> = WIDE BEAM	Standard ON-OFF add/aggiungere <b>DD</b> = DALI

Plasterboard brackets included/ Staffe cartongesso incluse



#### ENVIRONMENTS

Urban landscape, façades and architectural works, hallway, residential lighting.

#### PHYSICAL FEATURES

Body: Corrosion resistant die-cast aluminium body.  
 High impact resistant composite technopolymer housing box.  
 AISI 316 stainless steel frame sandblasted.  
 Diffuser: Extra clear tempered glass  
 Screws: AISI 304 stainless steel screws  
 Seals: Silicone Rubber

#### ELECTRICAL FEATURES

Driver: Integral ON-OFF or DALI  
 Voltage: 220-240V  
 Frequency: 50-60Hz  
 Wiring: Pre-wired and tested with resin sealed watertight

#### SOURCES

LED 4000K CRI>80 - 3000K CRI>80  
 MacAdam: Step 3  
 Lifetime: 50.000h L80B10 (Ta=25°C)

#### PERFORMANCE

Up to: 102 lm/W

#### CONTESTI

*Aree urbane/verdi, facciate e architetture, spazi d'accesso, illuminazione residenziale.*

#### CARATTERISTICHE FISICHE

*Corpo: in alluminio pressofuso, resistente alla corrosione.  
 Cassaforma in tecnopolimero composito ad alta resistenza.  
 Telaio in acciaio inox AISI 316 sabbato.  
 Diffusore: Vetro temperato extra chiaro  
 Viteria: Viteria inox AISI 304  
 Guarnizioni: Gomma ai siliconi*

#### CARATTERISTICHE ELETTRICHE

*Driver: Integrato ON-OFF o DALI  
 Tensione: 220-240V  
 Frequenza: 50-60Hz  
 Cablaggio: Completo di spezzone di cavo collaudato a tenuta*

#### SORGENTI

LED 4000K CRI>80 - 3000K CRI>80  
 MacAdam: Step 3  
 Durata: 50.000h L80B10 (Ta=25°C)

#### PERFORMANCE

Fino a: 102 lm/W

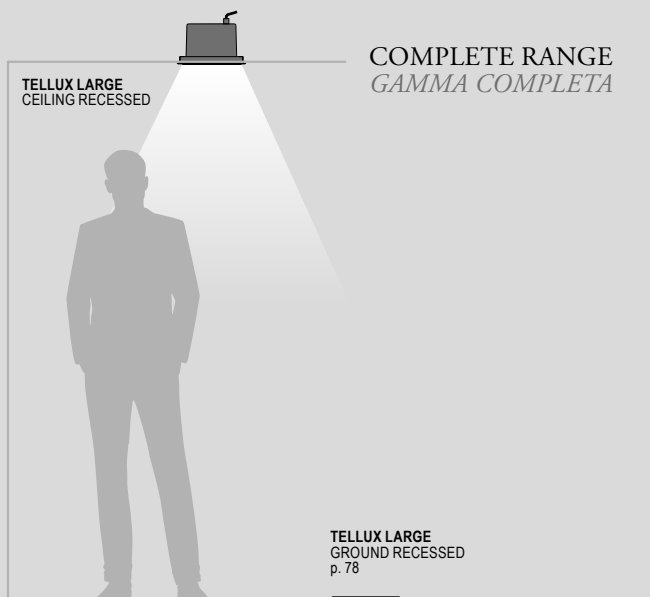

COMPLETE RANGE  
GAMMA COMPLETA

TELLUX LARGE  
CEILING RECESSED

TELLUX LARGE  
GROUND RECESSED  
p. 78



#### OPTIONAL ACCESSORIES

#### ACCESSORI OPZIONALI

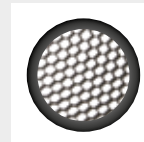

Optional honeycomb anti-glare louver  
 (already included only for NB optic).  
*Griglia honeycomb antiabbagliamento  
 opzionale (già inclusa solo per ottica NB).*

Accessories factory assembled.  
 Please order with products.  
*Accessori montati in fabbrica.  
 Si prega di ordinarli in contemporanea  
 con i prodotti.*



# TELLUX LARGE

## SIZE / DIMENSIONI

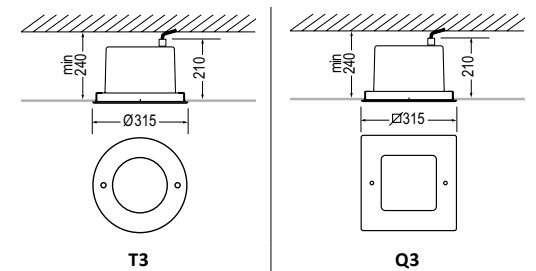

Size	Ø 315 mm		315x315mm
Total system power max	36,6 W	43W COB	36,6 W
Lumen output max	3290 lm	4381 lm	3290 lm

## OPTIC / OTTICHE

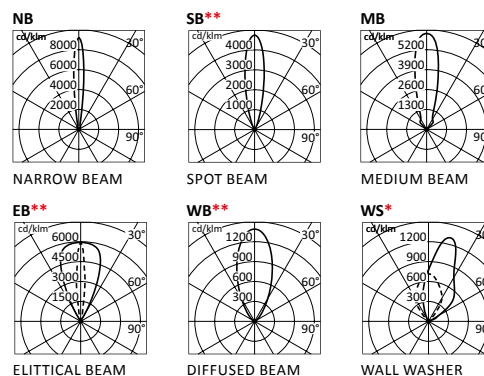

\* Only for /Solo per COB    \*\* Only for /Solo per Volvendo

## PRODUCT CODES / CODICI PRODOTTO

**D 4 2 K / T 3 - 2 1 V L W N - M B**

PRODUCT PRODOTTO	LED	LIGHTING COLORS COLORI DELLA LUCE	BEAMS FASCI	CONTROLS CONTROLLI
<b>D42K/T3</b> = TELLUX LARGE ceiling recessed	<b>9V</b> = VOLVENDO POWER LED 22,4W <b>21V</b> = VOLVENDO POWER LED 36,6W <b>1</b> = COB 28W <b>2</b> = COB 43W	<b>LWN</b> = 4000K CRI>80 <b>LWW</b> = 3000K CRI>80	<b>NB</b> = NARROW BEAM <b>SB**</b> = SPOT BEAM <b>MB</b> = MEDIUM BEAM <b>EB**</b> = ELLIPTICAL BEAM <b>WB**</b> = WIDE BEAM <b>WS*</b> = WALL WASHER	Standard ON-OFF add/aggiungere <b>DD</b> = DALI

\* Only for /Solo per COB    \*\* Only for /Solo per Volvendo    Plasterboard brackets included / Staffe cartongesso incluse

**D 4 2 K / Q 3 - 2 1 V L W N - M B**

PRODUCT PRODOTTO	LED	LIGHTING COLORS COLORI DELLA LUCE	BEAMS FASCI	CONTROLS CONTROLLI
<b>D42K/Q3</b> = TELLUX Q3 ceiling recessed	<b>9V</b> = VOLVENDO POWER LED 22,4W <b>21V</b> = VOLVENDO POWER LED 36,6W	<b>LWN</b> = 4000K CRI>80 <b>LWW</b> = 3000K CRI>80	<b>NB</b> = NARROW BEAM <b>SB</b> = SPOT BEAM <b>MB</b> = MEDIUM BEAM <b>EB</b> = ELLIPTICAL BEAM <b>WB</b> = WIDE BEAM	Standard ON-OFF add/aggiungere <b>DD</b> = DALI

Plasterboard brackets included / Staffe cartongesso incluse

# CEILING SURFACE







 | 
  | 
  | 
 

 | 
  | 
 

#### ENVIRONMENTS

Wellness, hallway, conference hall, art and culture, office, leisure areas, retail areas, study areas.

#### PHYSICAL FEATURES

**Painting:** Powder coat painting after multi-layer polyester pre-treatment for corrosion resistance.  
**Body:** Corrosion resistant extruded aluminium body powder-coated. Internal structure made of extruded aluminium and laser-shaped matching AISI 304 stainless steel parts.  
**Diffuser:** PC with surface treatment scratch-resistant and anti-aging UV rays.

#### ELECTRICAL FEATURES

**Driver:** Integral ON-OFF  
**Voltage:** 220-240V  
**Frequency:** 50-60Hz  
**Wiring:** Electrical harness wired for 220-240V-AC 50-60Hz power supply. 1.5mm<sup>2</sup> LN terminal block. Electronic ballast.

#### SOURCES

**LED** 4000K CRI>90 3000K CRI>90  
**MacAdam:** Step 2  
**Lifetime:** 50.000h L80B10 (Ta=25°C)

#### PERFORMANCE

Up to: 107 lm/W

#### CONTESTI

Wellness, spazi d'accesso, sale conferenze, arte e cultura, ufficio, intrattenimento, vendita e commercio, studio ed educazione.

#### CARATTERISTICHE FISICHE

**Verniciatura:** a polveri previo pre-trattamento con multistrato in poliestere ad alta resistenza alla corrosione.  
**Corpo:** in alluminio estruso, resistente alla corrosione, verniciato a polvere. Struttura interna in estruso di alluminio e parti in acciaio inox AISI 304 sagomato al laser.  
**Diffusore:** PC con trattamento superficiale antigraffio e anti invecchiamento ai raggi UV.

#### CARATTERISTICHE ELETTRICHE

**Driver:** Integrato ON-OFF  
**Tensione:** 220-240V  
**Frequenza:** 50-60Hz  
**Cablaggio:** elettrico alimentato a 220-240V-AC 50-60Hz. Morsettiera LN 1,5mm<sup>2</sup>. Alimentatore elettronico.

#### SORGENTI

**LED** 4000K CRI>90 3000K CRI>90  
**MacAdam:** Step 2  
**Durata:** 50.000h L80B10 (Ta=25°C)

#### PERFORMANCE

Fino a: 107 lm/W

## OPTICAL ACCESSORIES

### ACCESSORI OTTICI

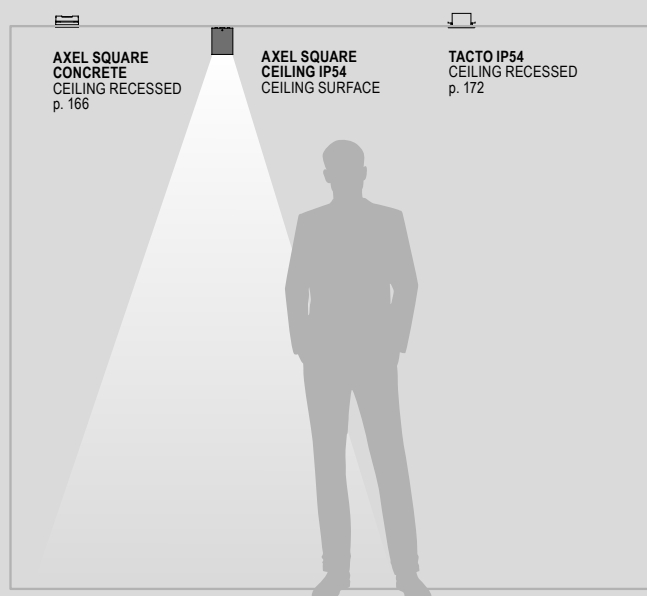

**Honeycomb anti-glare louver.**  
 Griglia honeycomb antiabbagliamento.



**Parallel grid.**  
 Griglia parallela.

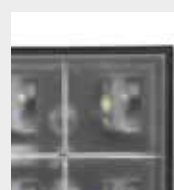

**Internal louver for Wall washer optics (can be ordered only with products).**  
 Louver interno per ottica Wall washer (è possibile ordinarlo solo in contemporanea con il prodotto).

**Accessories factory assembled.**  
 Please order with products.  
 Accessori montati in fabbrica.  
 Si prega di ordinarli in contemporanea con i prodotti.



# AXEL SQUARE CEILING

## SIZE / DIMENSIONI

	C4	C9
Total system power	7 W	21 W
Lumen output max	540 lm	2242 lm

## OPTIC / OTTICHE

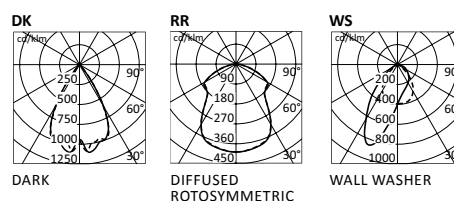

## PRODUCT CODES / CODICI PRODOTTO

# 1 8 0 9 - D N - 9 2 6 9

PRODUCT PRODOTTO	VERSIONS VERSIONI	FINISH FINITURE	LIGHTING COLORS & BEAMS COLORI DELLA LUCE & FASCI
18 = AXEL SQUARE CEILING IP54	09 = C4 ON OFF (7W) 13 = C9 ON OFF (21W)	DN = WHITE GR = GRAPHITE CO = CORTEN	Please visit website Visita il sito internet example/esempio: 9269 = 3000K CRI>90 DARK beam



BOX/C0 | | IP65 | IK06 | |

BOX/C1-C2 | | IP65 | IK07 | |

|

#### ENVIRONMENTS

Urban landscape, façades and architectural works, wellness, hallway, art and culture, retail areas, places of worship, residential lighting.

#### PHYSICAL FEATURES

Painting: Polyester powder coating, with a pluri-processed against corrosion (passed the exposure of over 1500 hours in a saline mist environment).  
 Body: Corrosion resistant die-cast aluminium body  
 Diffuser: Extra clear tempered glass  
 Screws: AISI 304 stainless steel screws  
 Seals: Silicone Rubber

#### ELECTRICAL FEATURES

Driver: Integral ON-OFF or DALI  
 Voltage: 220-240V  
 Frequency: 50-60Hz  
 Wiring: Use only (EN 60598-1) cable type H07RN-F

#### SOURCES

LED 4000K CRI>80 3000K CRI>80  
 MacAdam: Step 2  
 Lifetime: 60.000h L90B10(Ta=25°C)

#### PERFORMANCE

Up to: 180 lm/W

#### CONTESTI

*Aree urbane/verdi, facciate e architetture, wellness, spazi d'accesso, arte e cultura, vendita e commercio, luoghi di culto, illuminazione residenziale.*

#### CARATTERISTICHE FISICHE

*Vericiatura: a polveri poliesteri, previo pluritrattamenti contro la corrosione (supera il test di 1500 ore in nebbia salina).  
 Corpo: in alluminio pressofuso, resistente alla corrosione.  
 Diffusore: Vetro temperato extra chiaro  
 Viteria: Viteria inox AISI 304  
 Guarnizioni: Gomma ai siliconi*

#### CARATTERISTICHE ELETTRICHE

*Driver: Integrato ON-OFF o DALI  
 Tensione: 220-240V  
 Frequenza: 50-60Hz  
 Cablaggio: Ingresso linea utilizzare solo (EN 60598-1) cavo tipo H07RN-F.*

#### SORGENTI

*LED 3000 CRI> 80 4000 CRI> 80  
 MacAdam: Step 2  
 Durata: 60.000h L90B10 (Ta=25°C)*

#### PERFORMANCE

*Fino a: 180 lm/W*

#### OPTICAL ACCESSORIES

##### ACCESSORI OTTICI



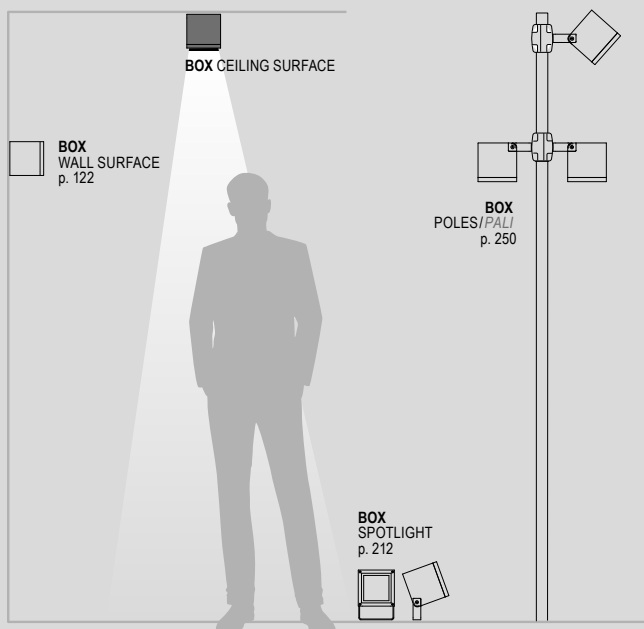

**Honeycomb anti-glare louver.**  
*Griglia honeycomb antiabbagliamento.*  
**Accessories factory assembled. Please order with products.**  
*Accessori montati in fabbrica. Si prega di ordinarli in contemporanea con i prodotti.*



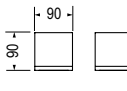
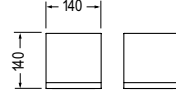

# BOX

## SIZE / DIMENSIONI

	BOX/C0	BOX/C1	BOX/C2	HP
				
Total system power	6,5 W	13,5 W	24 W	58 W
Lumen output max	770 lm	2430 lm	3278 lm	7245 lm

## OPTIC / OTTICHE

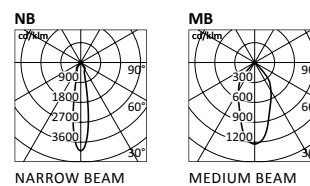

## PRODUCT CODES / CODICI PRODOTTO

# D58 / CO - 84 - NB - AL

PRODUCT PRODOTTO	SIZE DIMENSIONI	LIGHTING COLORS COLORI DELLA LUCE	BEAMS FASCI	CONTROLS CONTROLLI	FINISH FINITURE
D58 = BOX ceiling surface	C0 = 90x90mm C1 = 140x140mm C2 = 207x207mm	84 = 4000K CRI>80 83 = 3000K CRI>80 84HP* = 4000K CRI>80 83HP* = 3000K CRI>80	NB = NARROW BEAM MB = MEDIUM BEAM	standard ON-OFF add/aggiungere DD -** = DALI	AL = ALUMINIUM GREY GR = GRAPHITE

\*HP=High power Only for/ Solo per C2 \*\*Only for / Solo per C1 - C2



◆ | IP65 or IP68 | IK10 | CE | 

IS

#### ENVIRONMENTS

Façades and architectural works, wellness, hallway, leisure areas, retail areas, industrial areas, places of worship.

#### PHYSICAL FEATURES

Body: End caps in AISI 316 stainless steel, tube in PC.  
Internal structure made of natural anodised extruded aluminium.

Diffuser: PC with anti-aging UV rays

Screws: AISI 316 stainless steel

Seals: Silicone Rubber

#### ELECTRICAL FEATURES

Driver: Remote ON-OFF or DALI

Voltage: 24V-DC

Wiring: Complete with pre-wired and tested watertight cable (L=2500mm).

#### SOURCES

LED 4000K CRI>80 3000K CRI>80

MacAdam: Step 3

Lifetime: 50.000h L80B50 (Ta=25°C)

#### PERFORMANCE

Up to: 103 lm/W

#### CONTESTI

Facciate e architetture, wellness, spazi d'accesso, intrattenimento, vendita e commercio, industria, luoghi di culto.

#### CARATTERISTICHE FISICHE

Corpo: Testate in inox AISI 316 e tubo in PC.

Struttura interna in estruso di alluminio anodizzato naturale.

Diffusore: PC con anti invecchiamento ai raggi UV

Viteria: inox AISI 316

Guarnizioni: Gomma ai siliconi.

#### CARATTERISTICHE ELETTRICHE

Driver: Remoto ON-OFF o DALI

Tensione: 24V-DC

Cablaggio: Completo di spezzone di cavo già collegato e collaudato a tenuta (L=2500mm).

#### SORGENTI

LED 4000K CRI>80 3000K CRI>80

MacAdam: Step 3

Durata: 50.000h L80B50 (Ta=25°C)

#### PERFORMANCE

Fino a: 103 lm/W

#### INSTALLATION POSSIBILITY POSSIBILITÀ D'INSTALLAZIONE



Pair of 316L AISI stainless steel brackets for ceiling/wall/floor installation (not walk-over).

Coppia di staffe in acciaio INOX AISI 316L per fissaggio a plafone/parete/terra (non calpestabile).

#### OPTIC / OTTICHE

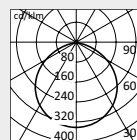

DIRECT



# CHIARO Ø30

## SIZE / DIMENSIONI

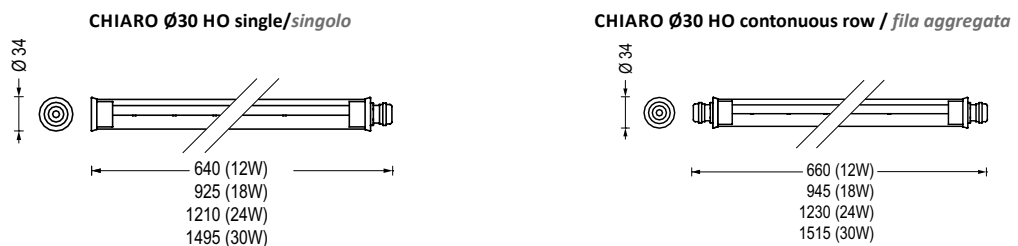

Total system power	10W	15W	20W	25W
Lumen output max	1026lm	1539lm	2052lm	2565lm

## CONFIGURATIONS / CONFIGURAZIONI

### CHIARO Ø30 Continuous row / Fila aggregata

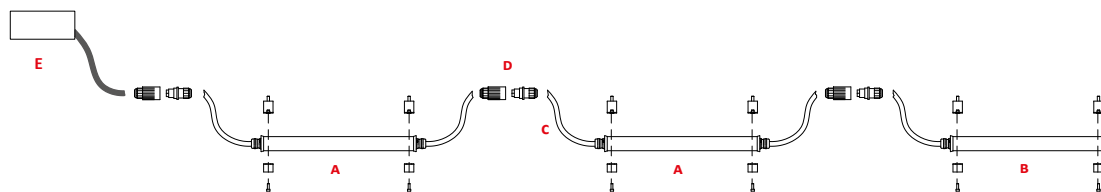

- A** CHIARO Continuous / Continuo
- B** CHIARO Single / Singolo

Included / incluso:

- C** CHIARO Continuous / Continuo  
2 cables / 2 cavi H05RN-F (L=2500mm)

- CHIARO Single / Singolo  
1 cables / 1 cavi H05RN-F (L=2500mm)

Not included / non inclusi:

- D** Connector / Connettore
- E** Remote driver / Driver remoto

## PRODUCT CODES / CODICI PRODOTTO

**1 0 7 K F 1 2 2**

PRODUCT PRODOTTO	TIPOLOGIA TIPOLOGIA	LIGHTING COLOR COLORI DELLA LUCE	LENGTHS LUNGHEZZE
107 = CHIARO	KF = IP65 SINGLE / SINGOLO KP = IP65 CONTINUOUS ROW / FILA AGGREGATA KL = IP68 SINGLE / SINGOLO KM = IP68 CONTINUOUS ROW / FILA AGGREGATA	10 = IP65 4000K CRI>80 11 = IP68 4000K CRI>80 12 = IP65 3000K CRI>80 13 = IP68 3000K CRI>80	2 = IP65 640 or 660 mm (12W) 3 = IP65 925 or 945 mm (18W) 4 = IP65 1210 or 1230 mm (24W) 5 = IP65 1495 or 1515 mm (30W) 7 = IP68 640 or 660 mm (12W) 8 = IP68 925 or 945 mm (18W) 9 = IP68 1210 or 1230 mm (24W) 0 = IP68 1495 or 1515 mm (30W)



**ENVIRONMENTS**

Façades and architectural works, wellness, hallway, leisure areas, retail areas, industrial areas, places of worship.

**PHYSICAL FEATURES**

Body: End caps in AISI 316 stainless steel, tube in PC.  
 Internal structure made of natural anodised extruded aluminium.  
 Diffuser: PC with anti-aging UV rays  
 Screws: AISI 304 stainless steel  
 Seals: Silicone Rubber

**ELECTRICAL FEATURES**

Driver: Integral ON-OFF or DALI  
 Voltage: 220-240V  
 Frequency: 50-60Hz  
 Wiring: Complete with pre-wired and tested watertight cable (L=2500mm).

**SOURCES**

LED 4000K CRI>80 3000K CRI>80  
 MacAdam: Step 3  
 Lifetime: 50.000h L80B10 (Ta=25°C)

**PERFORMANCE**

Up to: 127lm/W

**CONTESTI**

Facciate e architetture, wellness, spazi d'accesso, intrattenimento, vendita e commercio, industria, luoghi di culto.

**CARATTERISTICHE FISICHE**

Corpo: Testate in inox AISI 316 e tubo in PC.  
 Struttura interna in estruso di alluminio anodizzato naturale.  
 Diffusore: PC con anti invecchiamento ai raggi UV  
 Viteria: inox AISI 304  
 Guarnizioni: Gomma ai siliconi.

**CARATTERISTICHE ELETTRICHE**

Driver: Integrato ON-OFF o DALI  
 Tensione: 220-240VC  
 Frequenza: 50-60Hz  
 Cablaggio: Completo di spezzone di cavo già collegato e collaudato a tenuta (L=2500mm).

**SORGENTI**

LED 4000K CRI>80 3000K CRI>80  
 MacAdam: Step 3  
 Durata: 50.000h L80B10 (Ta=25°C)

**PERFORMANCE**

Fino a: 127lm/W

**INSTALLATION POSSIBILITY**  
**POSSIBILITÀ D'INSTALLAZIONE**



Pair of 316L AISI stainless steel brackets for ceiling/wall/floor installation (not walk-over).  
 Coppia di staffe in acciaio INOX AISI 316L per fissaggio a plafone/parete/terra (non calpestabile).

**OPTIC / OTTICHE**

Chiara Ø60 is characterised by its transparent polycarbonate tube with co-extruded opaline section.  
 Chiara Ø60 è caratterizzato da un tubo in policarbonato trasparente con porzione coestrusa opalina.

**TRANSPARENT / TRASPARENTE**

Source in the transparent part of the tube. Makes full use of the emitted flux.  
 Sorgente verso la parte trasparente del tubo. Si sfrutta al massimo il flusso emesso.

**OPAL / OPALE**

Source in the opaline part. Creates a perfectly uniform light though the entire length of the tube.  
 Sorgente verso la parte opalina. Si ottiene una luminosità perfettamente omogenea per tutta la lunghezza.





# CHIARO Ø60

## SIZE / DIMENSIONI

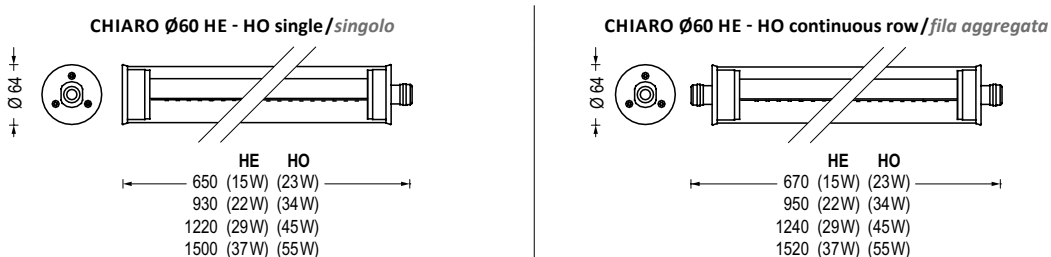

Versions	HE	HO	HE	HO	HE	HO	HE	HO
Total system power	15 W	23 W	22 W	34 W	29 W	45 W	37 W	55 W
Lumen output max	1847 lm	2603 lm	2769 lm	3905 lm	3692 lm	5206 lm	4614 lm	6508 lm

## ACCESSORIES / ACCESSORI

### CHIARO Ø60 Continuous row / Fila aggregata

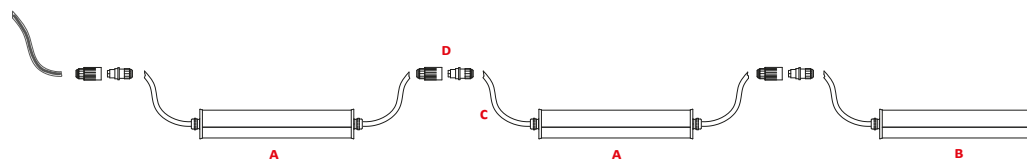

- A CHIARO Continuous / Continuo
- B CHIARO Single / Singolo

Included / incluso:

- C CHIARO Continuous / Continuo  
2 cables / 2 cavi H05RN-F  
(L=2500mm)

- CHIARO Single / Singolo  
1 cables / 1 cavi H05RN-F  
(L=2500mm)

Not included / non inclusi:  
D Connector / Connettore

## PRODUCT CODES / CODICI PRODOTTO

# T 1 0 7 P L 3 1 3

CONTROLS CONTROLLI	PRODUCT PRODOTTO	TIPOLOGY TIPOLOGIA	LENGTHS & LIGHTING COLORS LUNGHEZZE & COLORI DELLA LUCE
<p>T = ON-OFF</p> <p>DD = DALI</p> <p>1ET* = ON-OFF with 1h maintained emergency lighting kit</p>	107 = CHIARO	<p>PL = IP54 SINGLE / SINGOLO</p> <p>PM = IP54 CONTINUOUS ROW FILA AGGREGATA</p> <p>KL = IP66 SINGLE / SINGOLO</p> <p>KM = IP66 CONTINUOUS ROW FILA AGGREGATA</p>	<p>301-304 = HE - 4000K CRI&gt;80</p> <p>305-308 = HO - 4000K CRI&gt;80</p> <p>313-316 = HE - 3000K CRI&gt;80</p> <p>317-320 = HO - 3000K CRI&gt;80</p> <p>examples/esempi:</p> <p>301 = 15W 4000K CRI&gt;80</p> <p>302 = 22W 4000K CRI&gt;80</p> <p>305 = 23W 4000K CRI&gt;80</p> <p>306 = 34W 4000K CRI&gt;80</p>

\* Only for / Solo per L=1220 or L=1500











#### ENVIRONMENTS

Façades and architectural works, hallway, conference hall, art and culture, leisure areas, places of worship.

#### PHYSICAL FEATURES

Painting: Polyester powder coating, with a multi-process treatment against corrosion (pass the exposure to over 1500 hours in a saline mist environment).

Body: Extruded aluminium cylinder  
 Diffuser: Extra clear tempered glass  
 Screws: AISI 304 stainless steel screws  
 Seals: Silicone Rubber

#### ELECTRICAL FEATURES

Driver: Integral ON-OFF or DALI  
 Voltage: 220-240V  
 Frequency: 50-60Hz  
 Wiring: Complete with pre-wired and tested watertight H07RN-F cable.

#### SOURCES

LED 4000K CRI>80 - 3000K CRI>80  
 MacAdam: Step 2  
 Lifetime: 60.000h L90B10(Ta=25°C)

#### PERFORMANCE

Up to: 116 lm/W

#### CONTESTI

*facciate e architetture, spazi d'accesso, sale conferenze, arte e cultura, intrattenimento, luoghi di culto.*

#### CARATTERISTICHE FISICHE

*Verniciatura: a polveri poliesteri, previo pluritrattamenti contro la corrosione (supera il test di 1500 ore in nebbia salina).*

*Corpo: Cilindro in alluminio estruso  
 Diffusore: Vetro temperato extra chiaro  
 Viteria: inox AISI 304  
 Guarnizioni: Gomma ai siliconi*

#### CARATTERISTICHE ELETTRICHE

*Driver: Integrato ON-OFF o DALI  
 Tensione: 220-240V  
 Frequenza: 50-60Hz*

#### SORGENTI

*LED 4000K CRI>80 - 3000K CRI>80  
 MacAdam: Step 2  
 Durata: 60.000h L90B10(Ta=25°C)*

#### PERFORMANCE

*Fino a: 116 lm/W*

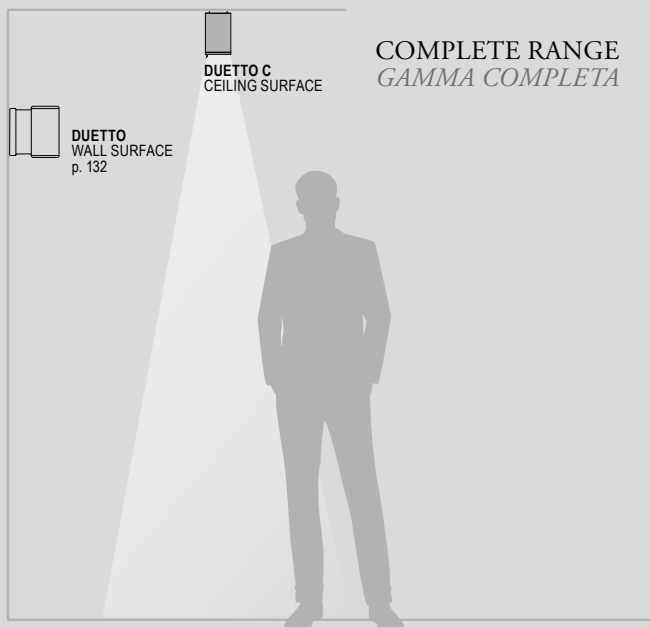

#### OPTIONAL ACCESSORIES ACCESSORI OPZIONALI



Diffused beam lens.  
*Lente a fascio  
 diffondente.*

Elliptical beam lens.  
*Lente a fascio ellittico.*

Honeycomb anti-glare  
 louver.  
*Griglia honeycomb  
 antiabbagliamento.*

Accessories factory assembled. Please order with products.  
*Accessori montati in fabbrica.  
 Si prega di ordinarli in contemporanea con i prodotti.*



# DUETTO C

## SIZE / DIMENSIONI

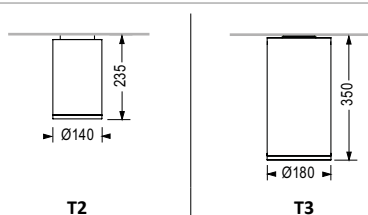

		HP	
Total system power	14 W	26 W	42 W
Lumen output max	1428 lm	3025 lm	4381 lm

## OPTIC / OTTICHE

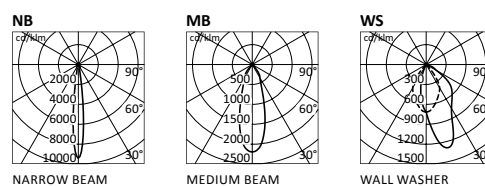

## PRODUCT CODES / CODICI PRODOTTO

# D 2 0 C / T 2 - 8 4 H P - N B - A L

PRODUCT PRODOTTO	SIZE DIMENSIONI	LIGHTING COLORS COLORI DELLA LUCE	BEAMS FASCI	CONTROLS CONTROLLI	FINISH FINITURE
D20 C = DUETTO ceiling surface	T2 = Ø 140 mm T3 = Ø 180 mm	84 = 4000K CRI>80 83 = 3000K CRI>80 84HP* = 4000K CRI>80 83HP* = 3000K CRI>80	NB = NARROW BEAM MB = MEDIUM BEAM WS** = WALL WASHER	standard ON-OFF add/aggiungere DD - = DALI	AL = ALUMINIUM GREY GR = GRAPHITE

\* Only for / Solo per T2 (HP=27W) \*\* Only for / Solo per T3



IP65 | IK09 | CE | 

#### ENVIRONMENTS

Wellness, hallway, conference hall, art and culture, leisure areas, retail areas.

#### PHYSICAL FEATURES

Body: High performance polymer sheath.

#### ELECTRICAL FEATURES

Driver: Remote ON-OFF or DALI  
Voltage: 24V - DC

#### SOURCES

LED 4000K CRI>80 - 3000K CRI>80  
MacAdam: Step 3  
Lifetime: 50.000h L70B50 (Ta=25°C)

#### PERFORMANCE

Up to: 42 lm/W

#### CONTESTI

Wellness, spazi d'accesso, sale conferenze, arte e cultura, intrattenimento, vendita e commercio

#### CARATTERISTICHE FISICHE

Corpo: Guaina flessibile in polimero ad alte prestazioni.

#### CARATTERISTICHE ELETTRICHE

Driver: remoto ON-OFF o DALI  
Tensione: 24V - DC

#### SORGENTI

LED 4000K CRI>80 - 3000K CRI>80  
MacAdam: Step 3  
Durata: 50.000h L70B50 (Ta=25°C)

#### PERFORMANCE

Fino a: 42 lm/W

## BEYOND THE CATALOGUE

- IP67 at request / IP67 a richiesta
- Recessed mounting / Montaggio a incasso
- Custom lengths up to 5m / Lunghezze custom fino a 5m

## VERSION / VERSIONI

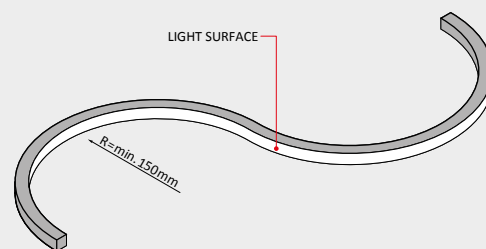

#### FILO FLEX Front bending

Straight lines on at or curved surfaces.  
Linee rettilinee su superfici piane e curve.

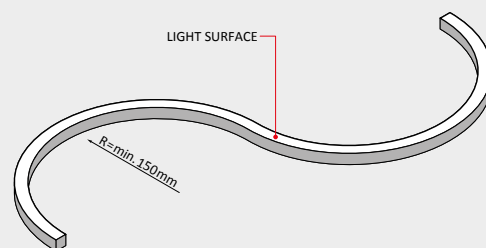

#### FILO FLEX Side bending

Straight and curved lines on at surfaces.  
Linee rettilinee e curve su superfici piane.

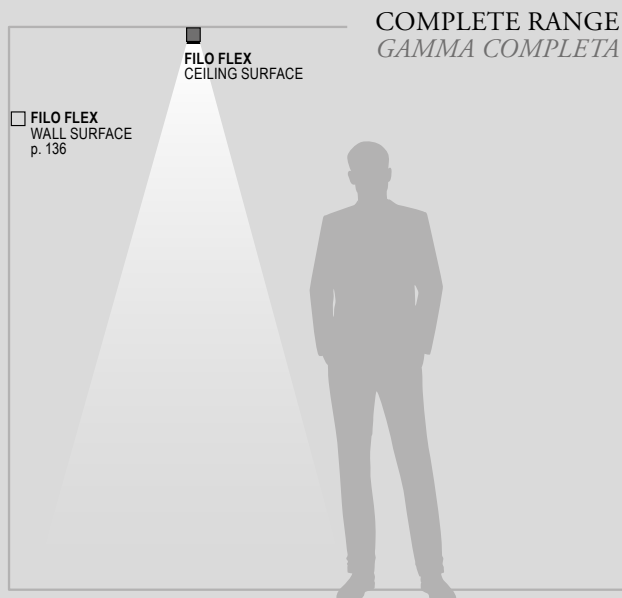



# FILO FLEX

## SIZE / DIMENSIONI

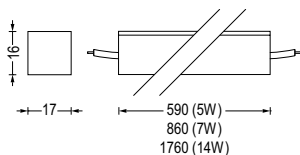

**FILO FLEX Front bending**

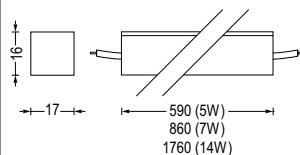

**FILO FLEX Side bending**

Total system power	15 W	15 W
Lumen output max	630 lm	496 lm

## OPTIC / OTTICHE

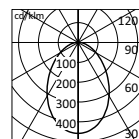

## PRODUCT CODES / CODICI PRODOTTO

# 1 0 8 D U 0 5 1

PRODUCT PRODOTTO	VERSIONS VERSIONI	LIGHTING COLORS COLORI DELLA LUCE	SIZE DIMENSIONI
<b>108DU</b> = FILO FLEX IP65	<b>0</b> = FRONT BENDING <b>2</b> = SIDE BENDING	<b>5</b> = 3000K CRI>80 <b>0</b> = 4000K CRI>80	<b>1</b> = 590mm <b>2</b> = 860mm <b>4</b> = 1760mm











#### ENVIRONMENTS

Hallway, residential lighting.

#### PHYSICAL FEATURES

Painting: Polyester powder coating, with a multi-process treatment against corrosion (pass the exposure to over 1500 hours in a saline mist environment).

Body: Corrosion resistant die-cast aluminium body

Diffuser: Opal tempered glass

#### ELECTRICAL FEATURES

Driver: Integral ON-OFF or DALI

Voltage: 220-240V

Frequency: 50-60Hz

Wiring: predisposed for daisy chain wiring, internal derivation terminal block screws 3x2,5mm<sup>2</sup> use only (EN 60598-1) cable type H07RN-F with diameter between 7 and 10mm.

#### SOURCES

Sources: LED 4000K CRI>80 3000K CRI>90

MacAdam: Step 3

Lifetime: 70.000h L80B10 (Ta=25°C)

#### PERFORMANCE

Up to: 65 lm/W

#### CONTESTI

Spazi d'accesso, illuminazione residenziale.

#### CARATTERISTICHE FISICHE

Verniciatura: a polveri poliesteri, previo pluritrattamenti contro la corrosione (supera il test di 1500 ore in nebbia salina).

Corpo: in alluminio pressofuso, resistente alla corrosione

Diffusore: Vetro temperato opale

#### CARATTERISTICHE ELETTRICHE

Driver: integrato ON-OFF o DALI

Tensione: 220-240V

Frequenza: 50-60Hz

Cablaggio: predisposti per linea passante, derivazione interna morsetto 3x2,5mm<sup>2</sup> utilizzare solo (EN 60598-1) cavo tipo H07RN-F con diametro compreso tra 7 e 10mm.

#### SORGENTI

Sorgenti: LED 4000K CRI>80 3000K CRI>90

MacAdam: Step 3

Durata: 70.000h L80B10 (Ta=25°C)

#### PERFORMANCE

Fino a: 65 lm/W

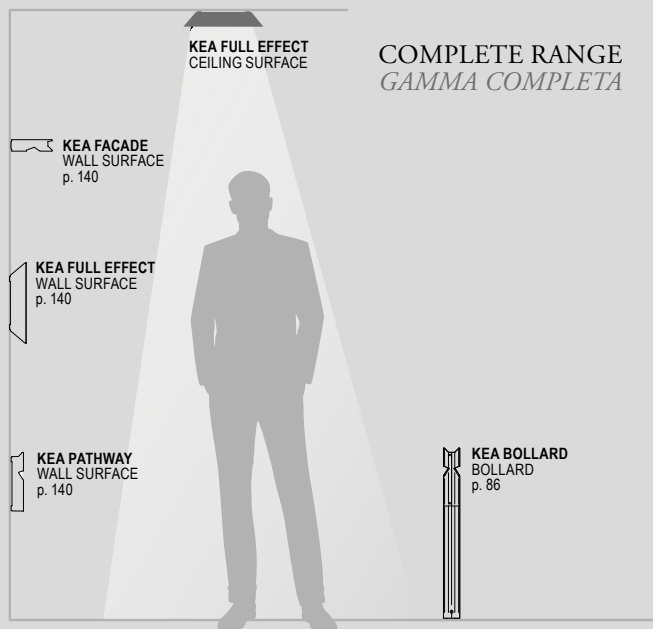

#### OPTIONAL ACCESSORIES ACCESSORI OPZIONALI



**KEA Full effect**  
Concrete rough-in housing.  
Cassaforma incasso cemento.

#### INDOOR VERSION VERSIONI INDOOR

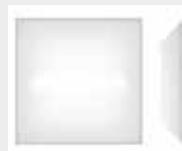

**KEA Full effect**  
Indoor catalogue  
Catalogo interni  
pag. 60

**KEA**

DESIGN BY HABIT(S)

## SIZE / DIMENSIONI

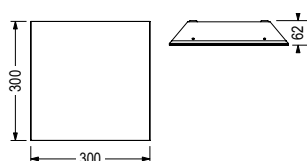

KEA Full effect

		Emergency 230V	Emergency battery
Total system power	24 W	19 W	7,5 W
Lumen output max	1390 lm	1230 lm	330 lm

## OPTIC / OTTICHE

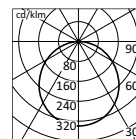

DIFFUSED

## PRODUCT CODES / CODICI PRODOTTO

**D 6 8 / E 1 - 8 4 - G R**

PRODUCT PRODOTTO	VERSIONS VERSIONI	LIGHTING COLORS COLORI DELLA LUCE	CONTROLS CONTROLLI	FINISH FINITURE
D68 = KEA	E1 = Full effect	84 = 4000K CRI>80 93 = 3000K CRI>90	standard ON-OFF add/aggiungere DD - = DALI standard NO EMERGENCY add/aggiungere 3E - = 3H EMERGENCY	AL = ALUMINIUM GREY DN - EMBOSSED WHITE GR = GRAPHITE CO = CORTEN



⊕ | IP54 | CE

#### ENVIRONMENTS

Industrial areas, study areas, railway areas, subway areas.

#### PHYSICAL FEATURES

Painting: Powder painting after passivation

Body: Natural anodised extruded aluminium structure.  
Die-cast aluminium end caps.

Diffuser: PMMA Opal

#### ELECTRICAL FEATURES

Driver: Integral ON-OFF

Voltage: 220-240V

Frequency: 50-60Hz

Wiring: Electrical harness wired for 220-240V-AC 50-60Hz.  
2.5mm<sup>2</sup> LTN irreversible quick coupling plug/socket.  
Electronic ballast.

#### SOURCES

LED 3000K CRI>80

MacAdam: Step 2

Lifetime: 50.000h L80B50 (Ta=25°C)

#### PERFORMANCE

Up to: 109 lm/W

#### CONTESTI

industria, studio ed educazione, aree ferroviarie,  
aree metropolitane.

#### CARATTERISTICHE FISICHE

Verniciatura: a polveri previa passivazione

Corpo: Struttura in estruso di alluminio anodizzato naturale.  
Testate in pressofusione di alluminio.

Diffusore: PMMA opale

#### CARATTERISTICHE ELETTRICHE

Driver: Integrato ON OFF

Tensione: 220-240V

Frequenza: 50-60Hz

Cablaggio: elettrico alimentato a 220-240V-AC 50-60Hz.  
Connettore ad innesto rapido M/F irreversibile LTN 2,5mm<sup>2</sup>.  
Alimentatore elettronico.

#### SORGENTI

LED 3000K CRI>80

MacAdam: Step 2

Durata: 50.000h L80B50 (Ta=25°C)

#### PERFORMANCE

Fino a: 109 lm/W





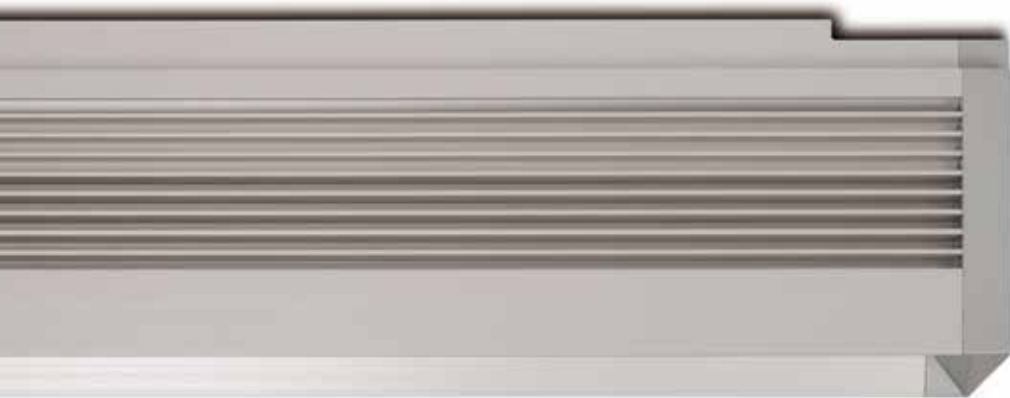

# SL.EVO LED IP54

## SIZE / DIMENSIONI

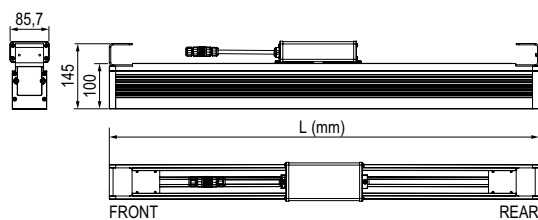

Size	<b>1156 mm</b>	<b>2276 mm</b>
Total system power	21 W	45 W
Lumen output max	2280 lm	4560 lm

## OPTIC / OTTICHE

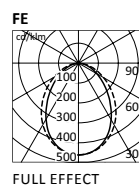

## PRODUCT CODES / CODICI PRODOTTO

### **T 9 0 C A . . . 1**

PRODUCT PRODOTTO	VERSIONS VERSIONI	LENGTH LUNGHEZZA
<b>T90CA = SL.EVO IP54</b>	Custom fixing system to be developed for each project. Please contact our technical department ... = <i>Sistema di fissaggio personalizzato da sviluppare per ogni progetto.</i> <i>Si prega di contattare il nostro ufficio tecnico</i>	<b>1 = 1156 mm (21 W)</b> <b>2 = 2276 mm (45 W)</b>

# CEILING PENDANT





IP54 | CE | DALI

AL

#### ENVIRONMENTS

hallway, conference hall, office, retail areas, industrial areas, study areas, places of worship.

#### PHYSICAL FEATURES

Painting: Polyester powder coating, with a multi-process treatment against corrosion (pass the exposure to over 1500 hours in a saline mist environment).

Body: Die-cast light alloy cap.  
High resistance composite technopolymers hooks.

Diffuser: Extra clear tempered glass  
Screws: AISI 304 stainless steel screws  
Seals: Silicone Rubber

#### ELECTRICAL FEATURES

Driver: Integral ON-OFF or DALI  
Voltage: 220-240V  
Frequency: 50-60Hz

#### SOURCES

LED 4000K CRI>80 3000K CRI>80  
MacAdam: Step 2  
Lifetime: SOSIA 60.000h L90B10 (Ta=25°C)  
SOSIA BOX 50.000h L90B10 (Ta=25°C)

#### PERFORMANCE

Up to: 134 lm/W

#### CONTESTI

Spazi d'accesso, sale conferenze, ufficio, vendita e commercio, industria, studio ed educazione, luoghi di culto.

#### CARATTERISTICHE FISICHE

Verniciatura: a polveri poliesteri, previo pluritrattamenti contro la corrosione (supera il test di 1500 ore in nebbia salina).

Corpo: Calotta in alluminio pressofuso.  
Ganci in tecnopolimeri compositi ad alta resistenza.

Diffusore: Vetro temperato extra chiaro  
Viteria: Viteria inox AISI 304  
Guarnizioni: Gomma ai siliconi

#### CARATTERISTICHE ELETTRICHE

Driver: Integrato ON-OFF o DALI  
Tensione: 220-240V  
Frequenza: 50-60Hz

#### SORGENTI

LED 4000K CRI>80 3000K CRI>80  
MacAdam: Step 2  
Durata: SOSIA 60.000h L90B10 (Ta=25°C)  
SOSIA BOX 50.000h L90B10 (Ta=25°C)

#### PERFORMANCE

Fino a: 134 lm/W

#### VERSIONS / VERSIONI



Aluminium body: anti glare comfort  
Opal body: indirect light to ceiling  
Corpo in alluminio:  
confort antiabbagliamento  
Corpo opale:  
luce indiretta verso il soffitto.

#### OPTIONAL ACCESSORIES

##### ACCESSORI OPZIONALI



Suspension kit extendable  
from 0.7 to 1.5 m  
from 1.5 to 3 m  
Kit di sospensione estensibile  
da 0,7 a 1,5 m  
da 1,5 a 3 m

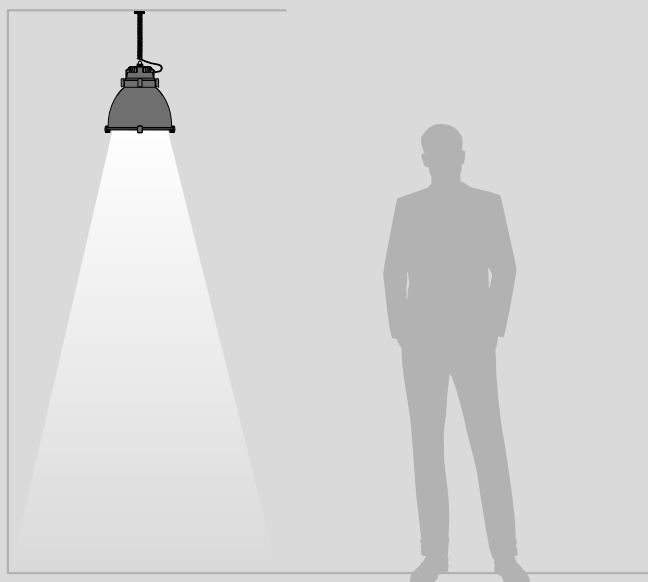



# SOSIA

## SIZE / DIMENSIONI

	<b>SOSIA</b>	<b>SOSIA OPAL</b>	<b>SOSIA BOX</b>
Total system power	41 W	36 W	79 W
Lumen output max	5501 lm	4748 lm	8698 lm

## OPTIC / OTTICHE

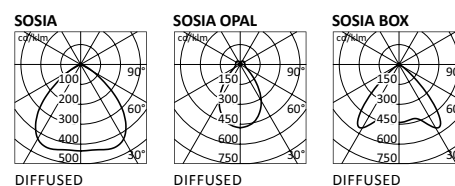

## SOSIA PRODUCT CODES / CODICI PRODOTTO

### D 0 6 K / L W N - 1 6 - A L

PRODUCT PRODOTTO	LIGHTING COLORS & VERSIONS COLORI DELLA LUCE & VERSIONI	CONTROLS CONTROLLI	FINISH FINITURE
<b>D06K</b> = SOSIA SOSIA OPAL	<b>LWN</b> = 4000K CRI>80 ALUMINIUM <b>LWW</b> = 3000K CRI>80 ALUMINIUM <b>OPLWN</b> = 4000K CRI>80 OPAL <b>OPLWW</b> = 3000K CRI>80 OPAL	<b>16</b> = ON OFF <b>16DD</b> = DALI	<b>AL*</b> = ALUMINIUM GREY

\* Only for aluminium version/ Solo per versioni in alluminio

## SOSIA BOX PRODUCT CODES / CODICI PRODOTTO

### D 0 6 K / L W N - H P 1 6 - A L

PRODUCT PRODOTTO	LIGHTING COLORS COLORI DELLA LUCE	CONTROLS CONTROLLI	FINISH FINITURE
<b>D06K</b> = SOSIA BOX	<b>LWN</b> = 4000K CRI>80 ALUMINIUM <b>LWW</b> = 3000K CRI>80 ALUMINIUM	<b>HP16</b> = ON OFF <b>HP16DD</b> = DALI	<b>AL</b> = ALUMINIUM GREY

# SPOTLIGHT



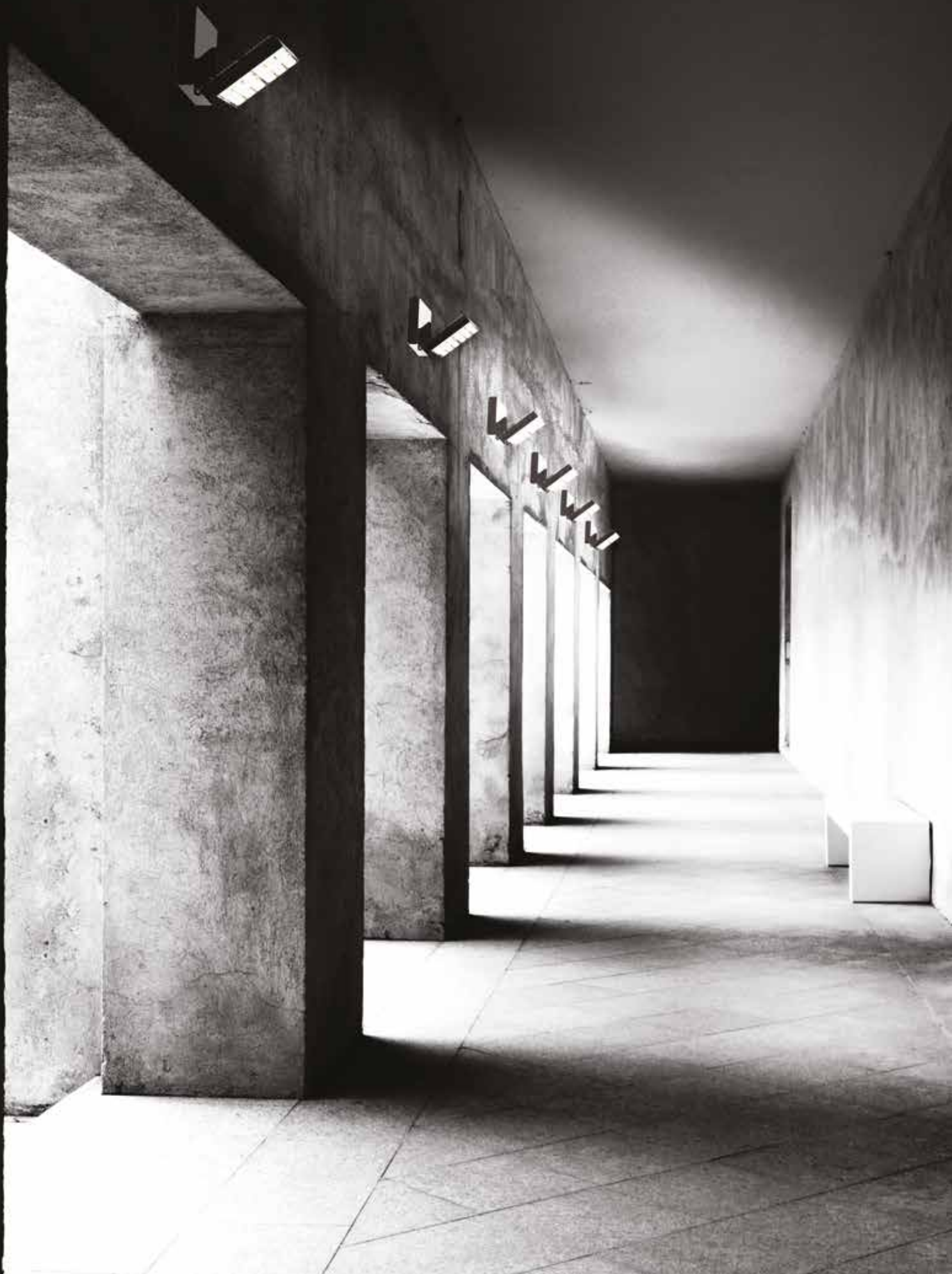





BE



**BE**

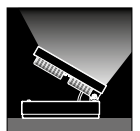

SPOTLIGHT



CONSTANT CURRENT  | IP65 | IK08 | CE |  

230V  | IP65 | IK08 | CE | 

 |   
GR DN

#### ENVIRONMENTS

Façades and architectural works, art and culture, places of worship.

#### PHYSICAL FEATURES

Body: AISI 304 stainless steel painted  
Diffuser: PC with surface treatment scratch-resistant and anti-aging UV rays.  
Screws: AISI 304 stainless steel screws

#### ELECTRICAL FEATURES

Driver: Remote ON-OFF or DALI (Constant Current)  
Integral ON-OFF (230V)  
Voltage: 230V  
Frequency: 50-60Hz  
Wiring: Complete with pre-wired and tested PUR cable L=600mm (Constant Current).  
Prewired with (EN 60598-1) cable type H07RN-F with diameter between 7,5 and 12mm (230V).

#### SOURCES

LED 4000K CRI>80 3000K CRI>80  
MacAdam: Step 2  
Lifetime: 50.000h L80B10 (Ta=25°C)

#### PERFORMANCE

Up to: 118 lm/W

#### CONTESTI

*Facciate e architetture, arte e cultura, luoghi di culto.*

#### CARATTERISTICHE FISICHE

Corpo: Acciaio inox AISI 304 verniciato  
Diffusore: PC con trattamento superficiale antigraffio e anti invecchiamento ai raggi UV.  
Viteria: Inox AISI 304

#### CARATTERISTICHE ELETTRICHE

Driver: Integrato ON-OFF  
Tensione: Remoto ON-OFF o DALI  
Frequenza: ON-OFF (230V)  
Cablaggio: Completo di spezzone di cavo PUR già collegato e collaudato a tenuta - L=600mm (Corrente costante)  
Precablato con cavo (EN 60598-1) tipo H07RN-F con diametro compreso tra 7,5 e 12mm (230V).

#### SORGENTI

LED 4000K CRI>80 3000K CRI>80  
MacAdam: Step 2  
Durata: 50.000h L80B10 (Ta=25°C)

#### PERFORMANCE

Fino a: 118 lm/W



BE/P4

COMPLETE RANGE  
GAMMA COMPLETA



BE/P2

BE/P1



#### OPTIONAL ACCESSORIES ACCESSORI OPZIONALI



Ground fixing spike.  
*Picchetto di infissione.*



# BE

## P1 S4 - P1 S9

### SIZE / DIMENSIONI

	BE P1 S4		BE P1 S9	
	CONSTANT CURRENT	230V	CONSTANT CURRENT	230V
Total system power	9 W	7 W	19 W	15 W
Lumen output max	1027 lm	772 lm	2236 lm	1680 lm

### OPTIC / OTTICHE

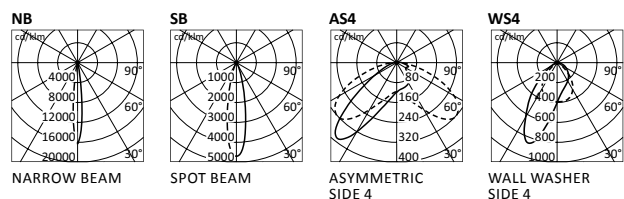

### OPTICAL ACCESSORIES/ACCESSORI OTTICI



**Aluminum adjustable barn doors.**  
*Alette frangiluce orientabili in alluminio.*

**Diffused beam lens.**  
*Lente a fascio diffondente.*

**Honeycomb anti-glare louver.**  
*Griglia antiabbagliamento a celle a nido d'ape.*

Accessories factory assembled. Please order with products.  
*Accessori montati in fabbrica. Si prega di ordinarli in contemporanea con i prodotti.*

### PRODUCT CODES / CODICI PRODOTTO

# 1 2 1 4 - G R - 0 0 0 1

PRODUCT PRODOTTO	VERSIONS VERSIONI	FINISH FINITURE	LIGHTING COLORS & BEAMS COLORI DELLA LUCE & FASCI
12 = BE IP65	14 = S4 CONSTANT CURRENT 15 = S9 CONSTANT CURRENT 16 = S4 230V 17 = S9 230V	GR = GRAPHITE DN = WHITE	Please visit website <i>Visita il sito internet</i> example/ <i>esempio</i> : <b>0001</b> = 3000K CRI>80 Narrow beam



#### ENVIRONMENTS

Façades and architectural works, art and culture, places of worship.

#### PHYSICAL FEATURES

Body: Housing made of AISI 304 stainless steel brake-formed and fully TIG welded, powder-coated.

Diffuser: PC with surface treatment scratch-resistant and anti-aging UV rays.

Screws: AISI 304 stainless steel screws

#### ELECTRICAL FEATURES

Driver: Integral ON-OFF

Voltage: 220-240V

Frequency: 50-60Hz

Wiring: Use only (EN 60598-1) H07RN-F cable with diameter between 7,5 and 12mm.

#### SOURCES

LED 4000K CRI>80 3000K CRI>80

MacAdam: Step 2

Lifetime: 50.000h L80B10 (Ta=25°C)

#### PERFORMANCE

Up to: 118 lm/W

#### CONTESTI

Facciate e architetture, arte e cultura, industria, luoghi di culto.

#### CARATTERISTICHE FISICHE

Corpo: Struttura in lamiera di acciaio inox AISI 304 presso-piegata, elettrosaldata a TIG, verniciata a polvere.

Diffusore: PC con trattamento superficiale antigraffio e anti invecchiamento ai raggi UV.

Viteria: Inox AISI 304

#### CARATTERISTICHE ELETTRICHE

Driver: Integrato ON-OFF

Tensione: 220-240V

Frequenza: 50-60Hz

Cablaggio: Utilizzare solo (EN 60598-1) cavo tipo H07RN-F con diametro compreso tra 7,5 e 12mm.

#### SORGENTI

LED 4000K CRI>80 3000K CRI>80

MacAdam: Step 2

Durata: 50.000h L80B10 (Ta=25°C)

#### PERFORMANCE

Fino a: 118 lm/W

## BEYOND THE CATALOGUE

- DALI at request / DALI a richiesta

## OPTICAL ACCESSORIES

### ACCESSORI OTTICI



Honeycomb anti-glare louver.

Griglia honeycomb antiabbagliamento.



Aluminum adjustable barn doors.

Alette frangiluce orientabili in alluminio.

Accessories factory assembled.  
Please order with products.

Accessori montati in fabbrica.

Si prega di ordinarli in contemporanea con i prodotti.

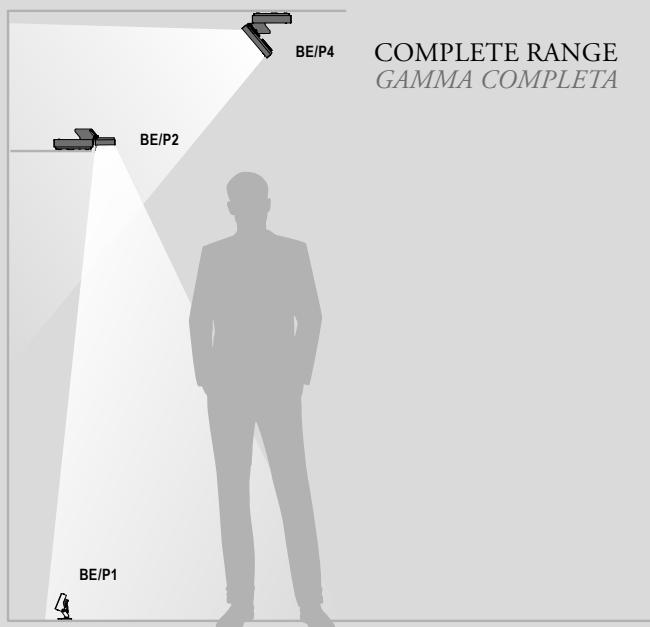



# BE

## P2 IP65 - P4 IP65

### SIZE / DIMENSIONI

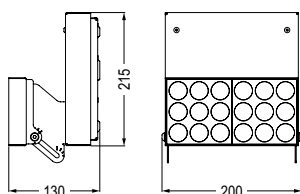
**BE P2 IP65**

Total system power

31 W

Lumen output max

3246 lm

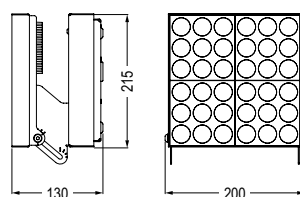
**BE P4 IP65**

Total system power

59 W

Lumen output max

6944 lm

### OPTIC / OTTICHE

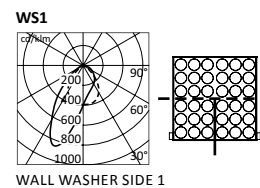
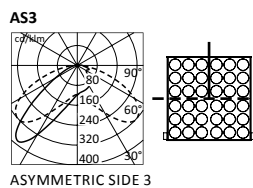
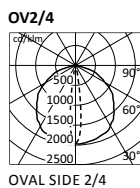
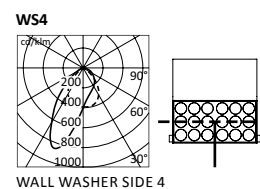
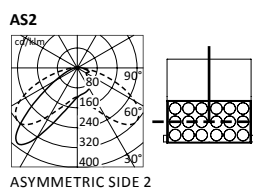
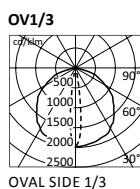
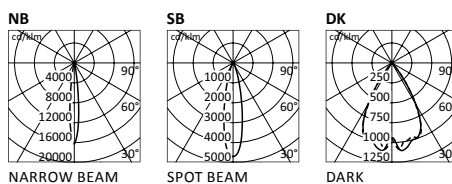

### PRODUCT CODES / CODICI PRODOTTO

**1 2 0 1 - G R - 0 7 9 4**

PRODUCT PRODOTTO	VERSIONS VERSIONI	FINISH FINITURE	LIGHTING COLORS & BEAMS COLORI DELLA LUCE & FASCI
12 = BE IP65	01 = P2 05 = P4	GR = GRAPHITE DN = WHITE	Please visit website Visita il sito internet example/eseempio: 0794 = 3000K CRI>80 Narrow beam





# BOX

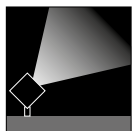

SPOTLIGHT

COMPLETE RANGE  
*GAMMA COMPLETA*

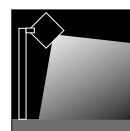

SPOTLIGHT

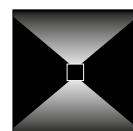

WALL  
SURFACE  
p. 122

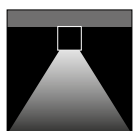

CEILING  
SURFACE  
p. 186



⊕ | IP65 | IK07 | CE | 

GR | AL

#### ENVIRONMENTS

Urban landscape, street lighting, façades and architectural works, industrial areas, places of worship.

#### PHYSICAL FEATURES

Painting: Polyester powder coating, with a multi-process treatment against corrosion (pass the exposure to over 1500 hours in a saline mist environment).

Body: Corrosion resistant die-cast aluminium body

Diffuser: Extra clear tempered glass

Screws: AISI 304 stainless steel screws

Seals: Silicone Rubber

#### ELECTRICAL FEATURES

Driver: Integral ON-OFF or DALI

Voltage: 220-240V

Frequency: 50-60Hz

Wiring: Use only (EN 60598-1) cable type H07RN-F with diameter between 7 and 10mm.

#### SOURCES

LED 4000K CRI>80 3000K CRI>80

MacAdam: Step 2

Lifetime: 60.000h L90B10 (Ta=25°C)

#### PERFORMANCE

Up to: 180 lm/W

#### CONTESTI

Aree urbane/verdi, illuminazione stradale, facciate e architetture, wellness, spazi d'accesso, industria, luoghi di culto.

#### CARATTERISTICHE FISICHE

Verniciatura: a polveri poliesteri, previo pluritrattamenti contro la corrosione (supera il test di 1500 ore in nebbia salina).

Corpo: Corpo in alluminio pressofuso, resistente alla corrosione

Diffusore: Vetro temperato extra chiaro

Viteria: Viteria inox AISI 304

Guarnizioni: Gomma ai siliconi

#### CARATTERISTICHE ELETTRICHE

Driver: Integrato ON-OFF o DALI

Tensione: 220-240V

Frequenza: 50-60Hz

Cablaggio: Ingresso linea utilizzare solo (EN 60598-1) cavo tipo H07RN-F con diametro compreso tra 7 e 10mm.

#### SORGENTI

LED 4000 CRI> 80 4000 CRI> 80

MacAdam: Step 2

Durata: 60.000h L90B10 (Ta=25°C)

#### PERFORMANCE

Fino a: 180 lm/W

#### OPTIONAL ACCESSORIES

##### ACCESSORI OPZIONALI



Universal pole connection. Suitable for one or two fixtures on conical or cylindrical poles with diameters between 65 and 80mm/60 and 63mm. *Ganascia per montaggio a palo. Idonea per montaggio di uno o due apparecchi su palo tronco-conico o cilindrico con diametri compresi tra 65 e 80mm/60 e 63mm.*

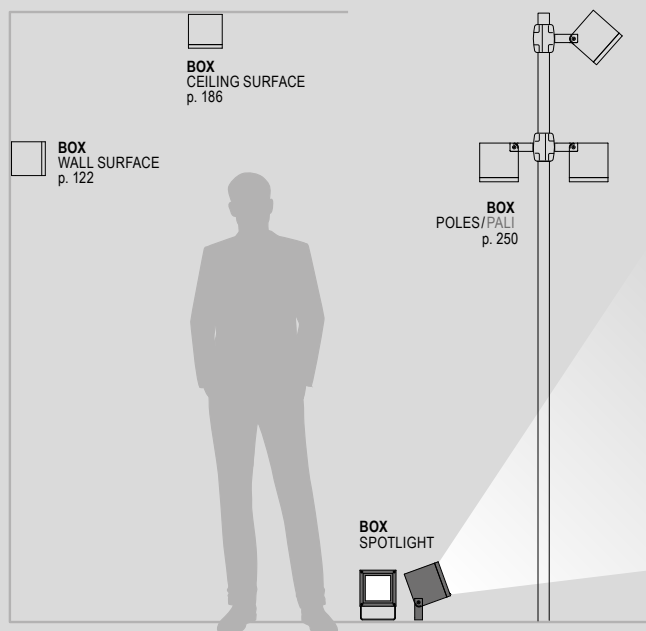





# BOX

## SIZE / DIMENSIONI

	BOX/P0	BOX/P1	BOX/P2	HP
Total system power	6,5 W	13,5 W	24 W	58 W
Lumen output max	770 lm	2430 lm	3278 lm	7245 lm

## BEAMS / FASCI

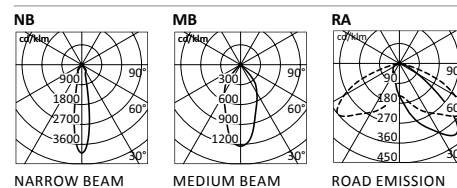

## OPTICAL ACCESSORIES / ACCESSORI OTTICI



Diffused beam lens.  
*Lente a fascio  
diffondente.*



Elliptical beam lens.  
*Lente a fascio ellittico.*



Anti-glare louver.  
*Griglia anabagliante.*

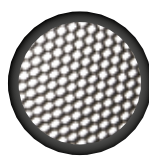

Honeycomb  
anti-glare louver.  
*Griglia honeycomb  
antiabbagliamento.*



Antiglare visor.  
*Visiera  
antiabbagliamento.*

Accessories factory assembled.  
Please order with products.  
*Accessori montati in fabbrica.  
Si prega di ordinarli in contemporanea  
con i prodotti.*

## PRODUCT CODES / CODICI PRODOTTO

**D 5 8 / P 2 - 8 4 - N B - D D - A L**

PRODUCT PRODOTTO	SIZE DIMENSIONI	LIGHTING COLORS COLORI DELLA LUCE	BEAMS FASCI	CONTROLS CONTROLLI	FINISH FINITURE
D58 = BOX spotlight	P0 = 90x90mm (6,5W) P1 = 140x140mm (13,5W) P2 = 207x207mm (24W)	84 = 4000K CRI>80 83 = 3000K CRI>80 84HP* = 4000K CRI>80 83HP* = 3000K CRI>80	NB = NARROW BEAM MB = MEDIUM BEAM RA** = ROAD EMISSION	standard ON-OFF add/aggiungere DD-** = DALI	AL = ALUMINIUM GREY GR = GRAPHITE

\*HP=High power (58W) Only for / Solo per P2 \*\*Only for / Solo per P1- P2

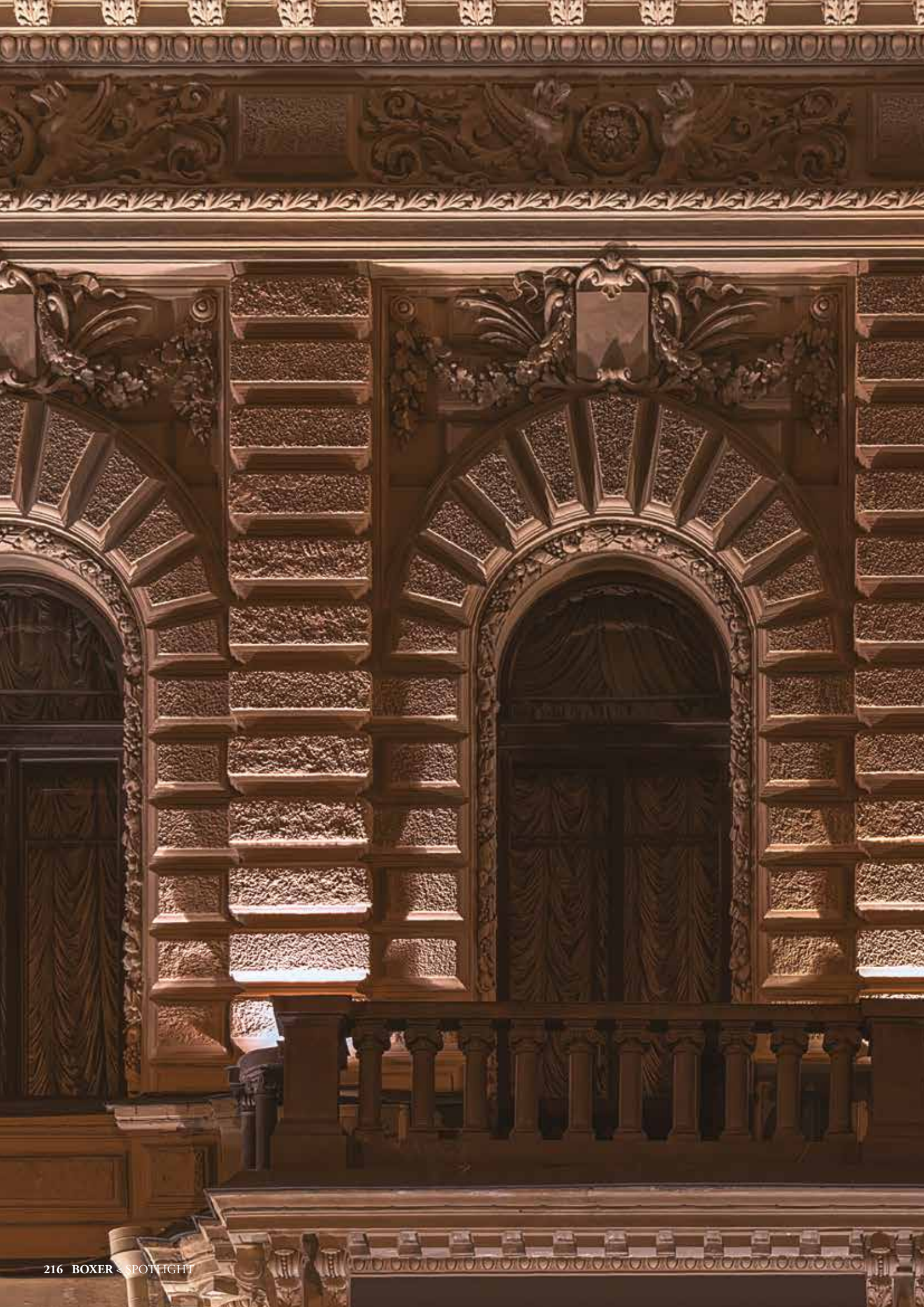



# BOXER

DESIGN BY HABIT(S)

**HIGH FLUX MODULAR FLOODLIGHTS**  
*PROIETTORI MODULARI AD ALTO FLUSSO*



SPOTLIGHT



**ENVIRONMENTS**

Urban landscape, façades and architectural works, industrial areas, places of worship.

**PHYSICAL FEATURES**

Painting: Polyester powder coating, with a multi-process treatment against corrosion (pass the exposure to over 1500 hours in a saline mist environment).

Body: Corrosion resistant die-cast aluminium body

Diffuser: Extra clear tempered glass

Silicon lenses (only for AS).

Screws: AISI 304 stainless steel screws

Seals: Silicone Rubber

**ELECTRICAL FEATURES**

Driver: ON-OFF or DALI

Voltage: 220-240V

Frequency: 50-60Hz

Wiring: Cable entry: predisposed for daisy chain wiring, internal derivation - terminal block screws 5x2,5mm<sup>2</sup> use only (EN 60598-1) cable type H07RN-F with diameter between 7,5 and 12mm.

**SOURCES**

LED 4000K CRI>80 3000K CRI>80

MacAdam: White Step 2 - RGBW Step 3

Lifetime: White 60.000h L90B10 (Ta25°)

RGBW 40.000h L90B10 (Ta25°)

**PERFORMANCE**

Up to: 133lm/W

**CONTESTI**

Aree urbane/verdi, facciate e architetture, industria, luoghi di culto.

**CARATTERISTICHE FISICHE**

Verniciatura: a polveri poliesteri, previo pluritrattamenti contro la corrosione (supera il test di 1500 ore in nebbia salina).

Corpo: in alluminio pressofuso, resistente alla corrosione

Diffusore: Vetro temperato extra chiaro

Lenti in silicone (solo per AS).

Viteria: Viteria inox AISI 304

Guarnizioni: Gomma ai siliconi

**CARATTERISTICHE ELETTRICHE**

Driver: ON-OFF o DALI

Tensione: 220-240V

Frequenza: 50-60Hz

Cablaggio: predisposti per linea passante, derivazione interna - morsetto 5x2,5mm<sup>2</sup> utilizzare solo (EN 60598-1) cavo tipo H07RN-F con diametro compreso tra 7,5 e 12mm.

**SORGENTI**

LED 4000K CRI>80 3000K CRI>80

MacAdam: White Step 2 - RGBW Step 3

Durata: White 60.000h L90B10 (Ta25°)

RGBW 40.000h L90B10 (Ta25°)

**PERFORMANCE**

Fino a: 133lm/W

COMPLETE RANGE  
GAMMA COMPLETA

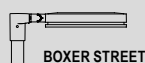

BOXER STREET

POLES/PALI  
p. 250

BOXER PROJECTOR  
SPOTLIGHT



**ZOS ZOOM ON SITE**



With vandal proof system. Easy adjusting gear to change the beam without opening the product (8°-40°).

Con sistema antivandalo. Ghiera per cambiare l'ampiezza del fascio senza aprire il prodotto (8°-40°).

**BEYOND THE CATALOGUE**



Custom version with 3 independent adjustable heads.  
Versione custom con 3 teste orientabili indipendenti.



# BOXER PROJECTOR

DESIGN BY HABIT(S)

## SIZE / DIMENSIONI

	PROJECTOR 2 LED	PROJECTOR 3 LED	PROJECTOR 3 LED RGBW	PROJECTOR 6 LED	PROJECTOR 6 LED RGBW
Total system power	40 W	62 W	49 W	124 W	95 W
Lumen output max	5334 lm	8003 lm	1845 lm	16006 lm	3690 lm

## BEAMS / FASCI

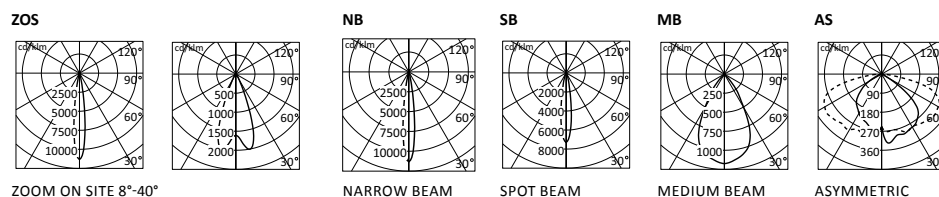

## OPTICAL ACCESSORIES ACCESSORI OTTICI



Honeycomb anti-glare louver.  
Griglia honeycomb antiabbagliamento.

Anti-glare visor.  
Visiera antiabbagliamento.

Accessories factory assembled.  
Please order with products.  
Accessori montati in fabbrica. Si prega di ordinarli in contemporanea con i prodotti.

## PRODUCT CODES / CODICI PRODOTTO

**D 7 0 / P - D D 2 Z O S 8 4 - G R**

PRODUCT PRODOTTO	CONTROLS CONTROLLI	VERSIONS VERSIONI	BEAMS FASCI	LIGHTING COLORS COLORI DELLA LUCE	FINISH FINITURE
D70/P = BOXER PROJECTOR	DD = DALI EL = ON-OFF DX* = DMX	2** = 2 COB VERTICAL 3 = 3 COB VERTICAL 3H = 3 COB HORIZONTAL 6H = 6 COB HORIZONTAL	ZOS** = ZOOM ON SITE NB** = NARROW BEAM SB = SPOT BEAM MB = MEDIUM BEAM AS** = ASYMMETRIC	83 = 3000K CRI>80 84 = 4000K CRI>80 RGBW	GR = GRAPHITE AL = ALUMINIUM GREY

\*Only for / Solo per RGBW \*\*Only for / Solo per WHITE



⊕ □ IP66 IK08 CE

GR AL

### ENVIRONMENTS

Street lighting

### PHYSICAL FEATURES

Painting: Polyester powder coating, with a multi-process treatment against corrosion (pass the exposure to over 1500 hours in a saline mist environment).

Body: Corrosion resistant die-cast aluminium body

Diffuser: Silicon lenses

Screws: AISI 304 stainless steel screws

Seals: Silicone Rubber

### ELECTRICAL FEATURES

Driver: ON-OFF

Voltage: 220-240V

Frequency: 50-60Hz

Wiring: Complete with pre-wired and tested watertight H07RN-F cable.

### SOURCES

LED 4000K CRI>80 3000K CRI>80

MacAdam: Step 2

Lifetime: 60.000h L90B10 (Ta25°)

### PERFORMANCE

Up to: 133lm/W

### CONTESTI

*Illuminazione stradale.*

### CARATTERISTICHE FISICHE

*Verniciatura: a polveri poliesteri, previo pluritrattamenti contro la corrosione (supera il test di 1500 ore in nebbia salina).*

*Corpo: in alluminio pressofuso, resistente alla corrosione*

*Diffusore: Lenti in silicone*

*Viteria: Viteria inox AISI 304.*

*Guarnizioni: Gomma ai siliconi.*

### CARATTERISTICHE ELETTRICHE

*Driver: ON-OFF*

*Tensione: 220-240V*

*Frequenza: 50-60Hz*

*Cablaggio: Completo di spezzone di cavo H07RN-F.*

### SORGENTI

LED 4000K CRI>80 3000K CRI>80

MacAdam: Step 2

Durata: 60.000h L90B10 (Ta25°)

### PERFORMANCE

Fino a: 133lm/W

### COMPLETE RANGE GAMMA COMPLETA

POLES/PALI  
p. 250

BOXER STREET

BOXER PROJECTOR  
SPOTLIGHT



### OPTIONAL ACCESSORIES ACCESSORI OPZIONALI



#### Pole connection.

Suitable for one or two fixtures Boxer Street on conical or cylindrical poles with diameters 60 or 76 mm.

*Ganascia per montaggio a palo.*

*Idonea per montaggio di uno o due apparecchi Boxer Street su palo tronco-conico o cilindrico con diametri 60 o 76 mm.*



# BOXER STREET

DESIGN BY HABIT(S)

## SIZE / DIMENSIONI

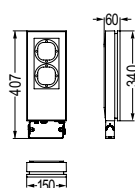
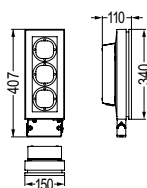
**STREET  
2 LED****STREET  
3 LED**

Total system power	40 W	62 W
Lumen output max	5335 lm	8003 lm

## BEAMS / FASCI

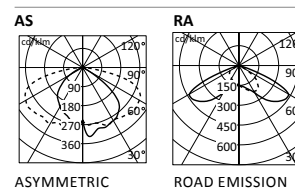

ASYMMETRIC

ROAD EMISSION

## PRODUCT CODES / CODICI PRODOTTO

**D 7 0 / S - E L 2 A S 8 4 - G R**

PRODUCT PRODOTTO	CONTROLS CONTROLLI	VERSIONS VERSIONI	BEAMS FASCI	LIGHTING COLORS COLORI DELLA LUCE	FINISH FINITURE
<b>D70/S</b> = BOXER STREET	<b>EL</b> = ON-OFF Class I <b>2EL</b> = ON-OFF Class II	<b>2</b> = 2 COB <b>3</b> = 3 COB	<b>AS</b> = ASYMMETRIC <b>RA</b> = ROAD EMISSION	<b>83</b> = 3000K CRI>80 <b>84</b> = 4000K CRI>80	<b>GR</b> = GRAPHITE <b>AL</b> = ALUMINIUM GREY







# BOXER ROUND

DESIGN BY HABIT(S)

NOW EVERYTHING IS COMPLETE

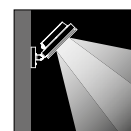

SPOTLIGHT



IP66 | IK08 | CE | DALI

GR AL

#### ENVIRONMENTS

Urban landscape, street lighting, façades and architectural works, industrial areas, places of worship.

#### PHYSICAL FEATURES

Painting: Polyester powder coating, with a multi-process treatment against corrosion (pass the exposure to over 1500 hours in a saline mist environment).

Body: Corrosion resistant die-cast aluminium body

Diffuser: Extra clear tempered glass

Screws: AISI 304 stainless steel screws

Seals: Silicone Rubber

#### ELECTRICAL FEATURES

Driver: ON-OFF or DALI or DMX (only for RGBW)

Voltage: 220-240V

Frequency: 50-60 Hz

Wiring: Predisposed for daisy chain wiring, internal derivation use only (EN 60598-1) cable type H07RN-F.

#### SOURCES

LED 3000K CRI>80 - 4000K CRI>80 - RGBW - DYNAMIC WHITE

MacAdam: Step 2 - STEP 3 (only for RGBW)

Lifetime: 60.000h L90B10 (Ta 25°)

#### PERFORMANCE

Up to: 129 lm/W

#### CONTESTI

Aree urbane/verdi, illuminazione stradale, facciate e architetture, industria, luoghi di culto.

#### CARATTERISTICHE FISICHE

Verniciatura: polveri poliesteri, previo pluritrattamenti contro la corrosione (supera il test di 1500 ore in nebbia salina).

Corpo: in alluminio pressofuso, resistente alla corrosione

Diffusore: Vetro temperato extra chiaro

Viteria: Viteria inox AISI 304

Guarnizioni: Gomma ai siliconi

#### CARATTERISTICHE ELETTRICHE

Driver: ON-OFF o DALI o DMX (solo per RGBW)

Tensione: 220-240V

Frequenza: 50-60 Hz

Cablaggio: predisposti per linea passante, derivazione interna utilizzare solo (EN 60598-1) cavo tipo H07RN-F.

#### SORGENTI

LED 3000K CRI>80 - 4000K CRI>80 - RGBW - DYNAMIC WHITE

MacAdam: Step 2 - STEP 3 (solo per RGBW)

Durata: 60.000h L90B10 (Ta 25°)

#### PERFORMANCE

Fino a: 129 lm/W

### COMPLETE RANGE GAMMA COMPLETA

BOXER ROUND  
POLES/PALI  
p. 250

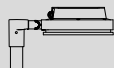

BOXER ROUND  
SPOTLIGHT



### OPTICAL ACCESSORIES ACCESSORI OTTICI



Diffused beam lens.  
Lente a fascio  
diffondente.

Elliptical beam lens.  
Can be turned on-site  
to adjust ellipse.  
Lente a fascio ellittico.  
Può essere ruotata  
durante il montaggio  
per orientare l'ellisse.

Honeycomb  
anti-glare louver.  
Griglia honeycomb  
antiabbagliamento.

Accessories factory assembled. Please order with products.  
Accessori montati in fabbrica.  
Si prega di ordinarli in contemporanea con i prodotti.



# BOXER ROUND

DESIGN BY HABIT(S)

## SIZE / DIMENSIONI

	<b>2 COB</b>	<b>3 COB</b>	<b>3 COB RGBW</b>	<b>4 COB</b>	<b>4 COB RGBW</b>
Total system power	45 W	67 W	49 W	90 W	65 W
Lumen output max	5805 lm	8642 lm	1845 lm	11610 lm	2460 lm

## BEAMS / FASCI

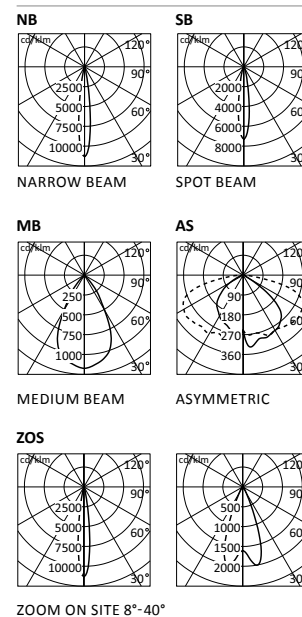

## ZOS ZOOM ON SITE



**With vandal proof system**  
*Con sistema antivandalo.*  
 Easy adjusting gear to change the beam without opening the product.  
*Ghiera per cambiare l'ampiezza del fascio senza aprire il prodotto.*  
 (8°-40°)

## PRODUCT CODES / CODICI PRODOTTO

**D 71 / P - DD 2 ZOS 84 - GR**

PRODUCT PRODOTTO	SIZE DIMENSIONI	CONTROLS CONTROLLI	VERSIONS VERSIONI	BEAMS FASCI	LIGHTING COLORS COLORI DELLA LUCE	FINISH FINITURE
<b>D71 = BOXER ROUND</b>	<b>P = PROJECTOR</b>	<b>DD = DALI</b> <b>EL = ON-OFF</b> <b>DX* = DMX</b>	<b>2 = 2 COB 40W</b> <b>3 = 3 COB 62W</b> <b>3 COB RGBW 49W</b> <b>4 = 4 COB 80W</b> <b>4 COB RGBW 65W</b>	<b>ZOS = ZOOM ON SITE</b> <b>NB = NARROW BEAM</b> <b>SB = SPOT BEAM</b> <b>MB = MEDIUM BEAM</b> <b>AS = ASYMMETRIC</b>	<b>84 = 4000K CRI&gt;80</b> <b>83 = 3000K CRI&gt;80</b> <b>DW** = DYNAMIC WHITE</b> <b>RGBW**</b>	<b>GR = GRAPHITE</b> <b>AL = ALUMINIUM GREY</b>

\*Only for / Solo per RGBW

\*\*Only for / Solo per 3 COB - 4 COB



#### ENVIRONMENTS

Urban landscape, street lighting, façades and architectural works, industrial areas, places of worship.

#### PHYSICAL FEATURES

Painting: Polyester powder coating, with a multi-process treatment against corrosion (pass the exposure to over 1500 hours in a saline mist environment).

Body: Corrosion resistant die-cast aluminium body.  
Aluminium mounting bracket.

Diffuser: Extra clear tempered glass

Screws: AISI 304 stainless steel screws

Seals: Silicone Rubber

#### ELECTRICAL FEATURES

Driver: Integral ON-OFF or DALI with surge protection 4kV

Voltage: 220-240V

Frequency: 50-60Hz

Wiring: Line entry: use only H07RN-F cable (EN 60598-1) with diameter between 7,5 and 12mm.

#### SOURCES

LED 4000K CRI>80 - 3000K CRI>80

MacAdam: Step 2

Lifetime: 60.000h L90B10 (Ta=25°C)

#### PERFORMANCE

Up to: 125 lm/W

#### CONTESTI

Aree urbane/verdi, illuminazione stradale, facciate e architetture, industria, luoghi di culto.

#### CARATTERISTICHE FISICHE

Verniciatura: a polveri poliesteri, previo pluritrattamenti contro la corrosione (supera il test di 1500 ore in nebbia salina).

Corpo: in alluminio pressofuso, resistente alla corrosione.  
Staffa di attacco in alluminio.

Diffusore: Vetro temperato extra chiaro

Viteria: Viteria inox AISI 304

Guarnizioni: Gomma ai siliconi

#### CARATTERISTICHE ELETTRICHE

Driver: Integrato ON-OFF o DALI con protezione scariche 4kV

Tensione: 220-240V

Frequenza: 50-60Hz

Cablaggio: utilizzare solo (EN 60598-1) cavo tipo H07RN-F con diametro compreso tra 7,5 e 12mm.

#### SORGENTI

LED 4000K CRI>80 - 3000K CRI>80

MacAdam: Step 2

Durata: 60.000h L90B10 (Ta=25°C)

#### PERFORMANCE

Fino a: 125 lm/W

## COMPLETE RANGE GAMMA COMPLETA

BOXER/T  
POLES/PALI  
p. 250

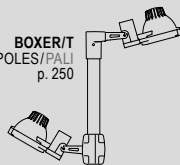

BOXER/T  
SPOTLIGHT



## BEYOND THE CATALOGUE

- Automatic midnight at request.  
Mezzanotte automatica a richiesta.

## OPTIONAL ACCESSORIES

### ACCESSORI OPZIONALI



Universal pole connection.  
Suitable for one or two fixtures on conical or cylindrical poles with diameters between 65 and 80mm/60 and 63mm.  
Ganascia per montaggio a palo.  
Idonea per montaggio di uno o due apparecchi su palo tronco-conico o cilindrico con diametri compresi tra 65 e 80mm/60 e 63mm.



# BOXER/T

## SIZE / DIMENSIONI

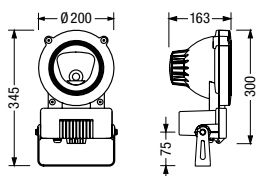

		HP
Total system power	28W	43W
Lumen output max	3309 lm	5394 lm

## BEAMS / FASCI

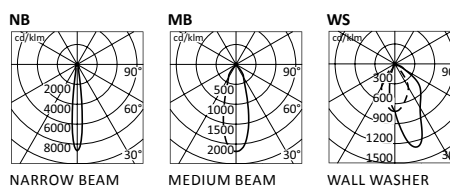

## OPTICAL ACCESSORIES / ACCESSORI OTTICI



Diffused beam lens.  
*Lente a fascio  
diffondente.*



Elliptical beam lens.  
*Lente a fascio  
ellittico.*



Screening shield.  
*Visiera schermante.*

Accessories factory assembled. Please order with products.  
*Accessori montati in fabbrica.  
Si prega di ordinarli in contemporanea con i prodotti.*





## PRODUCT CODES / CODICI PRODOTTO

# D 30 T / H P - L W N - M B - D D - A L

PRODUCT PRODOTTO	VERSION VERSIONI	LIGHTING COLORS COLORI DELLA LUCE	BEAMS FASCI	CONTROLS CONTROLLI	FINISH FINITURE
D30T = BOXER/T spotlight	standard 23W HP = 43W	LWN = 4000K CRI>80 LWW = 3000K CRI>80	NB* = NARROW BEAM MB = MEDIUM BEAM WS** = WALL WASHER	standard ON-OFF add/aggiungere DD-** = DALI	AL = ALUMINIUM GREY GR = GRAPHITE

\*Only for / Solo per standard 23W \*\*Only for / Solo per HP43W





#### ENVIRONMENTS

Urban landscape, façades and architectural works, wellness, hallway, art and culture, retail areas, places of worship, residential lighting.

#### PHYSICAL FEATURES

Painting: Polyester powder coating, with a multi-process treatment against corrosion (pass the exposure to over 1500 hours in a saline mist environment).

Body: Corrosion resistant die-cast aluminium body

Diffuser: Extra clear tempered glass

Screws: AISI 304 stainless steel screws

Seals: Silicone Rubber

#### ELECTRICAL FEATURES

Driver: Integral ON-OFF

Voltage: 220-240V

Frequency: 50-60Hz

Wiring: Pre-wired and tested with resin sealed watertight H05RN-F cable (for a fast and secure connection to the main power line, use ACS/CR1 connector or similar).

#### SOURCES

LED 4000K CRI>80 - 3000K CRI>80

MacAdam: Step 2

Lifetime: 60.000h L90B10 (Ta=25°C)

#### PERFORMANCE

Up to: 111 lm/W

#### CONTESTI

Aree urbane/verdi, facciate e architetture, wellness, spazi d'accesso, arte e cultura, vendita e commercio, luoghi di culto, illuminazione residenziale.

#### CARATTERISTICHE FISICHE

Verniciatura: a polveri poliesteri, previo pluritrattamenti contro la corrosione (supera il test di 1500 ore in nebbia salina).

Corpo: in alluminio pressofuso, resistente alla corrosione

Diffusore: Vetro temperato extra chiaro

Viteria: Inox AISI 304

Guarnizioni: Gomma ai siliconi

#### CARATTERISTICHE ELETTRICHE

Driver: Integrato ON-OFF

Tensione: 220-240V

Frequenza: 50-60Hz

Cablaggio: Completo di spezzone di cavo H05RN-F già collegato e collaudato a tenuta (per un rapido e sicuro collegamento alla linea elettrica utilizzare il connettore ACS/CR1 o similari).

#### SORGENTI

LED 4000K CRI>80 - 3000K CRI>80

MacAdam: Step 2

Durata: 60.000h L90B10 (Ta=25°C)

#### PERFORMANCE

Fino a: 111 lm/W

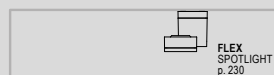

### COMPLETE RANGE GAMMA COMPLETA

FLEX SPOTLIGHT



### OPTIONAL ACCESSORIES ACCESSORI OPZIONALI



Wall mounting.  
Montaggio a parete.



Wall mounting arm.  
Braccio per montaggio a parete.



Ground fixing spike.  
Picchetto di infissione.



Support belt.  
Cinghia di sostegno.



# FLEX T0

## SIZE / DIMENSIONI

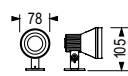
**T0**

Total system power	6,5W
Lumen output max	720 lm

## BEAMS / FASCI

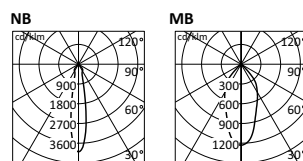

NARROW BEAM

MEDIUM BEAM

## OPTICAL ACCESSORIES / ACCESSORI OTTICI



Diffused beam lens.  
*Lente a fascio  
diffondente.*



Elliptical beam lens.  
*Lente a fascio  
ellittico.*

Accessories factory assembled. Please order with products.  
*Accessori montati in fabbrica. Si prega di ordinarli in contemporanea con i prodotti.*

## PRODUCT CODES / CODICI PRODOTTO

# D55 / T0 - 84 - NB - AL

PRODUCT PRODOTTO	SIZE DIMENSIONI	LIGHTING COLORS COLORI DELLA LUCE	BEAMS FASCI	FINISH FINITURE
D55 = FLEX spotlight	T0 = $\varnothing$ 78 x mm	84 = 4000K CRI>80 83 = 3000K CRI>80	NB = NARROW BEAM MB = MEDIUM BEAM	AL = ALUMINIUM GREY GR = GRAPHITE



#### ENVIRONMENTS

Urban landscape, façades and architectural works, wellness, hallway, art and culture, retail areas, places of worship.

#### PHYSICAL FEATURES

Painting: Polyester powder coating, with a multi-process treatment against corrosion (pass the exposure to over 1500 hours in a saline mist environment).

Body: Corrosion resistant die-cast aluminium body

Diffuser: Extra clear tempered glass

Screws: AISI 304 stainless steel screws

Seals: Silicone Rubber

#### ELECTRICAL FEATURES

Driver: Integral ON-OFF or DALI

Voltage: 220-240V

Frequency: 50-60Hz

Wiring: Use only (EN 60598-1) cable type H07RN-F

#### SOURCES

LED 4000K CRI>80 - 3000K CRI>80

MacAdam: Step 3

Lifetime: 80.000h L90B10 (Ta=25°C)

#### PERFORMANCE

Up to: 95 lm/W

#### CONTESTI

Aree urbane/verdi, facciate e architetture, wellness, spazi d'accesso, arte e cultura, vendita e commercio, luoghi di culto, illuminazione residenziale.

#### CARATTERISTICHE FISICHE

Verniciatura: a polveri poliesteri, previo pluritrattamenti contro la corrosione (supera il test di 1500 ore in nebbia salina).

Corpo: in alluminio pressofuso, resistente alla corrosione

Diffusore: Vetro temperato extra chiaro

Viteria: Viteria inox AISI 304

Guarnizioni: Gomma ai siliconi

#### CARATTERISTICHE ELETTRICHE

Driver: Integrato ON-OFF o DALI

Tensione: 220-240V

Frequenza: 50-60Hz

Cablaggio: Utilizzare solo (EN 60598-1) cavo tipo H07RN-F

#### SORGENTI

LED 4000K CRI>80 - 3000K CRI>80

MacAdam: Step 3

Durata: 80.000h L90B10 (Ta=25°C)

#### PERFORMANCE

Fino a: 95 lm/W

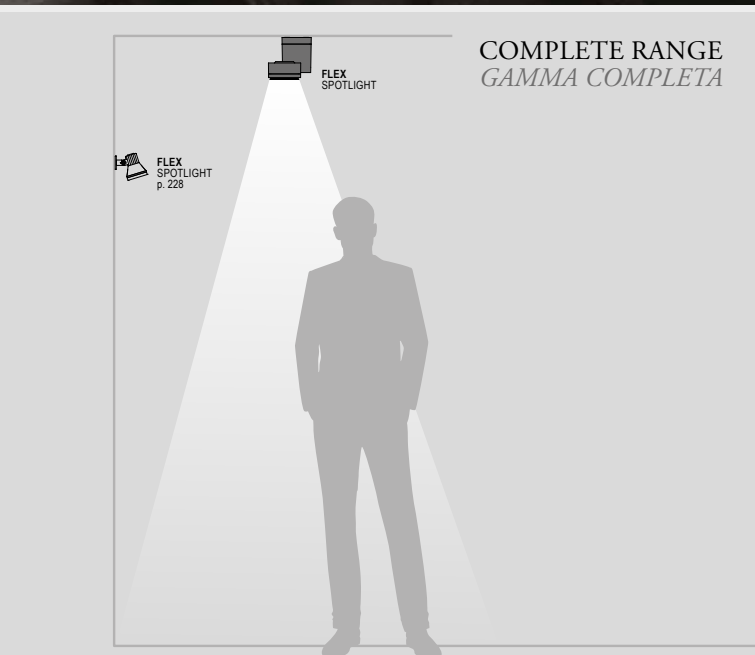

#### OPTICAL ACCESSORIES/ACCESSORI OTTICI

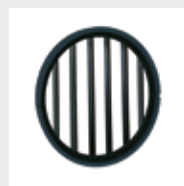

Anti-glare louver.  
Only for T1/Q1  
Griglia anabbagliante.  
Solo per T1/Q1



Aluminum adjustable barn doors.  
Only for T1/Q1  
Alette frangiluce orientabili in alluminio.  
Solo per T1/Q1



Aluminium shielding visor.  
Only for T1/Q1.  
Visiera schermante in alluminio.  
Solo per T1/Q1

#### OPTIONAL ACCESSORIES/ACCESSORI OPZIONALI



Wall mounting.  
Only for T1/Q1  
Braccio per montaggio a parete.  
Solo per T1/Q1



Universal pole connection minimum  $\varnothing$  60mm  
Ganascia per montaggio a palo minimo  $\varnothing$  60mm.





# FLEX

T1 - Q1 - T2

## SIZE / DIMENSIONI

	<p><b>T1</b></p>	<p><b>Q1</b></p>	<p><b>T2</b></p>
Total system power	13,5 W		22,4 W
Lumen output max	1169 lm		2118 lm

## OPTICAL ACCESSORIES / ACCESSORI OTTICI



Diffused beam lens.  
Lente a fascio  
diffondente.



Elliptical beam lens.  
Lente a fascio ellittico.

Accessories factory assembled. Please order with products. Accessori montati in fabbrica. Si prega di ordinarli in contemporanea con i prodotti.

## BEAMS / FASCI

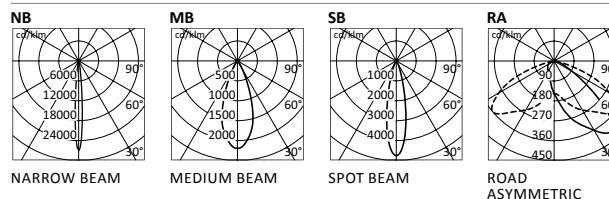

## PRODUCT CODES / CODICI PRODOTTO

**D 5 5 / T 1 - 5 L W N - M B - D D - A L**

PRODUCT PRODOTTO	VERSIONS / SIZE VERSIONI / DIMENSIONI	LIGHTING COLORS COLORI DELLA LUCE	BEAMS FASCI	CONTROLS CONTROLLI	FINISH FINITURE
D55 = FLEX spotlight	T1-5 = Ø116 x mm Q1-5 = Ø132 x mm T2-9 = Ø189 x mm	LWN = 4000K CRI>80 LWW = 3000K CRI>80	NB = NARROW BEAM MB = MEDIUM BEAM SB = SPOT BEAM RA* = ROAD ASYMMETRIC	standard ON-OFF add/aggiungere DD - = DALI	AL = ALUMINIUM GREY GR = GRAPHITE

\* Only for/ Solo per versioni Q1





---

# SNAP

MIND THE GAP

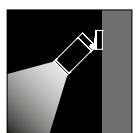

SPOTLIGHT



#### ENVIRONMENTS

Urban landscape, façades and architectural works, places of worship.

#### PHYSICAL FEATURES

Painting: Polyester powder coating, with a multi-process treatment against corrosion (pass the exposure to over 1500 hours in a saline mist environment).

Body: Extruded aluminium cylinder. Die-cast aluminium end caps

Diffuser: Extra clear tempered glass

Screws: AISI 304 stainless steel screws

Seals: Silicone Rubber

#### ELECTRICAL FEATURES

Driver: Remote ON-OFF or DALI (only Snap Ø40)

Integral ON-OFF or DALI (only Snap Ø90 and Ø140)

Voltage: 220-240V

Frequency: 50-60Hz

Wiring: Complete with pre-wired and tested watertight H07RN-F cable.

#### SOURCES

LED 3000K - 4000K CRI>80 - RGBW - DYNAMIC WHITE

MacAdam: Step 2

Lifetime: 60.000h L90B10 (Ta 25°)

#### PERFORMANCE

Up to: 114 lm/W

#### CONTESTI

Aree urbane/verdi, facciate e architetture, luoghi di culto.

#### CARATTERISTICHE FISICHE

Verniciatura: a polveri poliesteri, previo pluritrattamenti contro la corrosione (supera il test di 1500 ore in nebbia salina).

Corpo: Cilindro in alluminio estruso.

Testate in pressofusione d'alluminio.

Diffusore: Vetro temperato extra chiaro

Viteria: Viteria inox AISI 304

Guarnizioni: Gomma ai siliconi

#### CARATTERISTICHE ELETTRICHE

Remoto ON-OFF o DALI (solo Snap Ø40)

integrato ON-OFF o DALI (solo Snap Ø90 e Ø140).

Tensione: 220-240V

Frequenza: 50-60Hz

Cablaggio: Completo di spezzone di cavo H07RN-F già collegato e collaudato a tenuta.

#### SORGENTI

LED 3000K - 4000K CRI>80 e CRI>90 - RGBW - DYNAMIC WHITE

MacAdam: Step 2

Durata: 60.000h L90B10 (Ta 25°)

#### PERFORMANCE

Fino a: 114 lm/W

### TOTALLY ADJUSTABLE ORIENTAMENTO COMPLETO

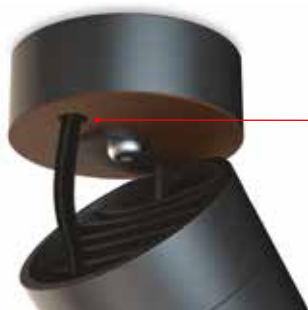

Reference points for horizontal orientation.  
Punti di riferimento per orientamento orizzontale.

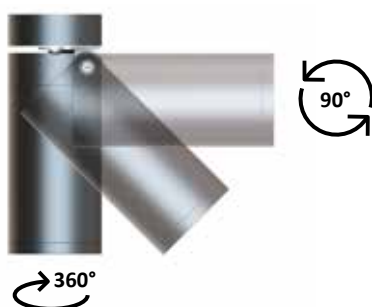

### OPTIONAL ACCESSORIES ACCESSORI OPZIONALI



Aluminium shielding visor.  
Visiera schermante in alluminio.

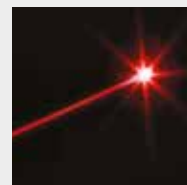

Laser pointing accessory.  
Accessorio puntamento laser.



# SNAP

## SIZE / DIMENSIONI

Size	Ø40	Ø90	Ø90HP	Ø140	Ø140HP
Total system power	2W	10W	20W	17W	35W
Lumen output max	200lm	1000lm	2200lm	1700lm	4000lm

## OPTIONAL ACCESSORIES / ACCESSORI OPZIONALI



Diffused beam lens.  
*Lente a fascio  
diffondente.*

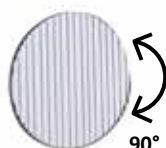

Elliptical beam lens.  
Can be turned on-site to  
adjust ellipse.  
*Lente a fascio ellittico.  
Può essere ruotata  
durante il montaggio  
per orientare l'ellisse.*

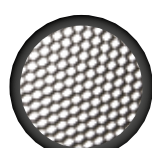

Honeycomb anti-glare  
louwer.  
*Griglia honeycomb  
antiabbagliamento.*

Accessories factory assembled.  
Please order with products.  
*Accessori montati in fabbrica.  
Si prega di ordinarli in contemporanea  
con i prodotti.*

## BEAMS / FASCI

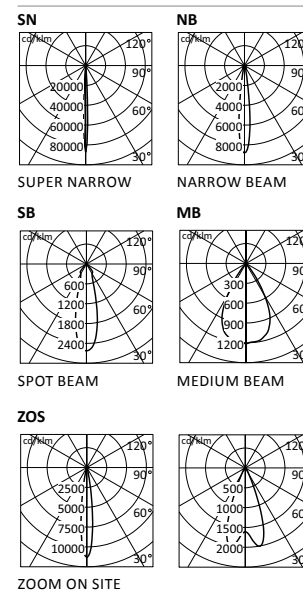

## PRODUCT CODES / CODICI PRODOTTO

# D 7 2 / 9 0 H P - E L 8 3 N B - G R

PRODUCT PRODOTTO	VERSIONS/SIZE VERSIONI/DIMENSIONI	CONTROLS CONTROLLI	LIGHTING COLORS COLORI DELLA LUCE	BEAMS FASCI	FINISH FINITURE
D72 = SNAP	40 = Ø 40 mm - 2W 90 = Ø 90 mm - 10W 90HP = Ø 90 mm - 20W 140 = Ø 140 mm - 17W 140HP = Ø 140 mm - 35W	EL* = ON-OFF DD* = DALI DX** = DMX	83 = 3000K CRI>80 84 = 4000K CRI>80 DW* = DYNAMIC WHITE RGBW*	SN* = SUPER NARROW NB = NARROW BEAM SB = SPOT BEAM MB = MEDIUM BEAM ZOS* = ZOOM ON SITE	GR = GRAPHITE AL = ALUMINIUM GREY DN = WHITE

\* Only for/ Solo per Ø90-140mm (Ø40mm remote driver) \*\*Only for RGBW/ Solo per RGBW

# HANDRAIL

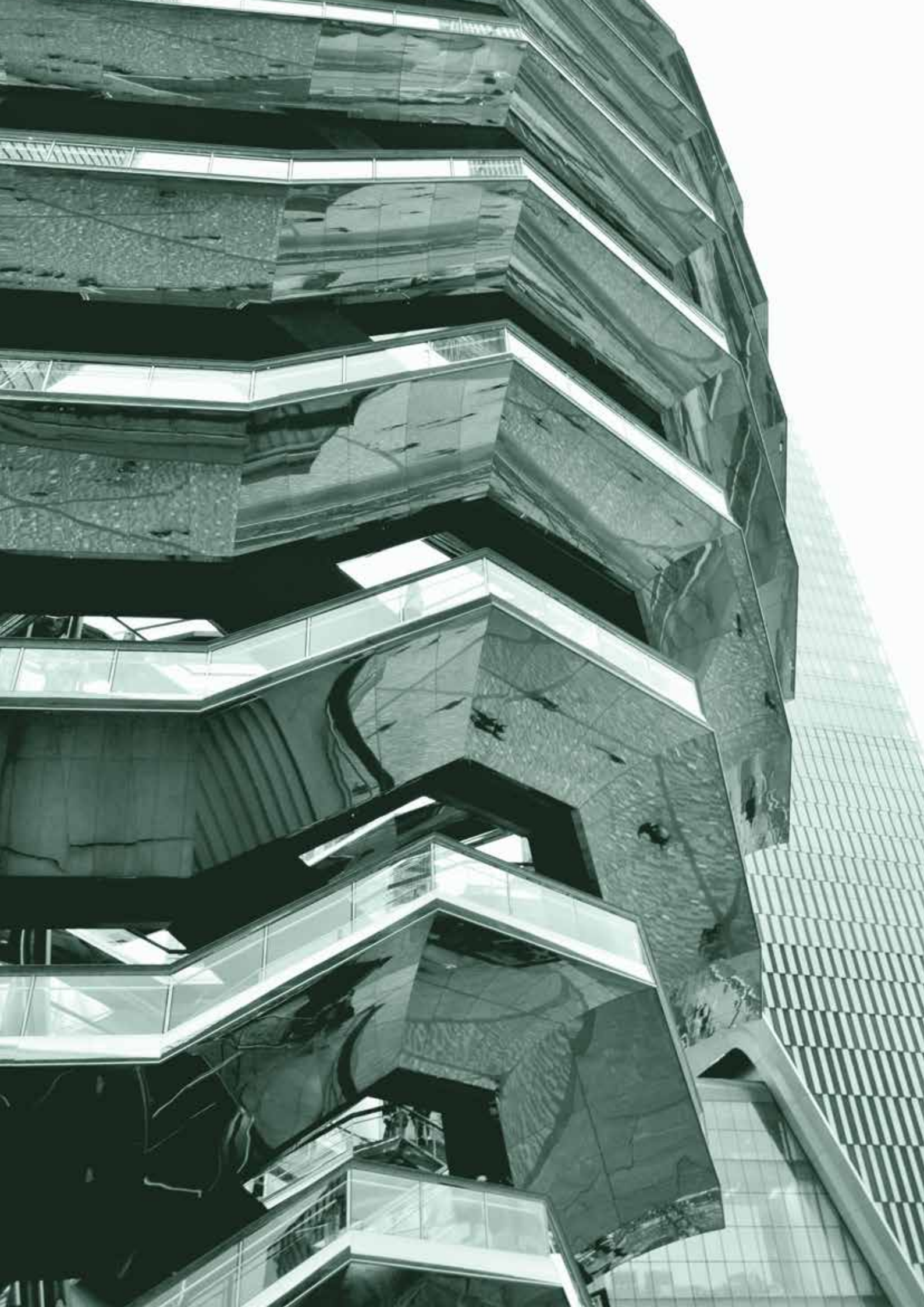

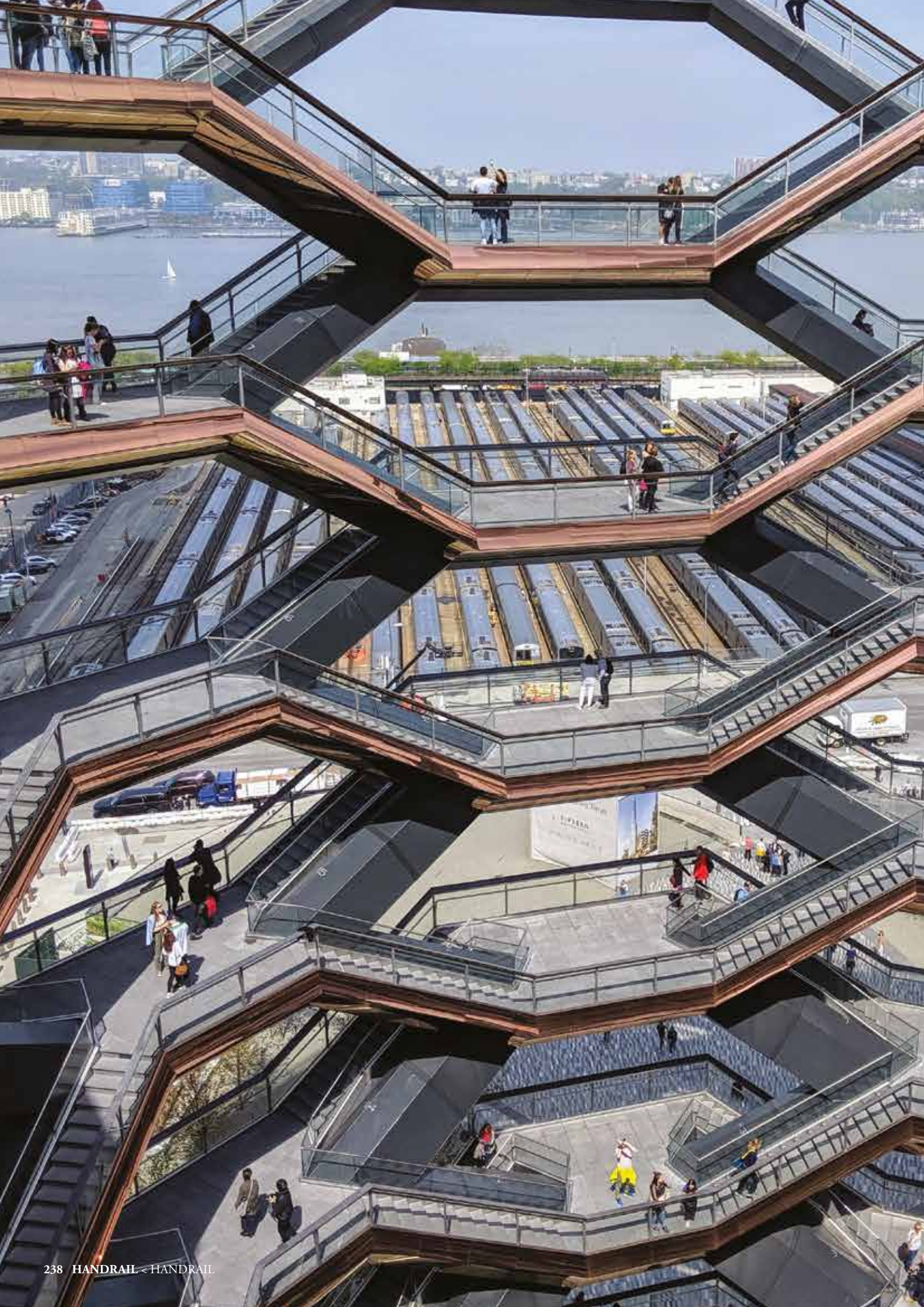





---

# HANDRAIL





IP67 | IK08 | CE | DALI

BS

#### ENVIRONMENTS

Urban landscape, street lighting, façades and architectural works, industrial areas, places of worship, residential lighting.

#### PHYSICAL FEATURES

Body: Corrosion resistant aluminium endcaps, body in stainless steel AISI 316.  
 Polycarbonate diffuser with internal anti-glare deflector.  
 Diffuser: PC with anti-aging UV rays  
 Screws: AISI 316 stainless steel screws  
 Seals: Silicone Rubber

#### ELECTRICAL FEATURES

Driver: Remote ON-OFF 1-10V or DALI  
 Voltage: 24V or 48V  
 Wiring: Predisposed for daisy chain wiring, internal derivation use only (EN 60598-1) cable type H07RN-F.

#### SOURCES

LED 3000K CRI>80 - 4000K CRI>80  
 MacAdam: Step 3  
 Lifetime: 50.000h L70B50 (Ta=25°C)

#### PERFORMANCE

Up to: 50 lm/W

#### CONTESTI

Aree urbane/verdi, facciate e architetture, industria, luoghi di culto, illuminazione residenziale.

#### CARATTERISTICHE FISICHE

Corpo: Testate in alluminio resistente alla corrosione, corpo in acciaio INOX AISI 316. Schermo in policarbonato con deflettore interno antiabbagliamento.  
 Diffusore: PC con anti invecchiamento ai raggi UV  
 Viteria: Viteria inox AISI 316  
 Guarnizioni: Gomma ai siliconi

#### CARATTERISTICHE ELETTRICHE

Driver: ON-OFF, 1-10V o DALI remoto  
 Tensione: 24V o 48V  
 Cablaggio: Predisposti per linea passante, derivazione interna utilizzare solo (EN 60598-1) cavo tipo H07RN-F.

#### SORGENTI

LED 3000K CRI>80 - 4000K CRI>80  
 MacAdam: Step 3  
 Durata: 50.000h L70B50 (Ta=25°C)

#### PERFORMANCE

Fino a: 50 lm/W

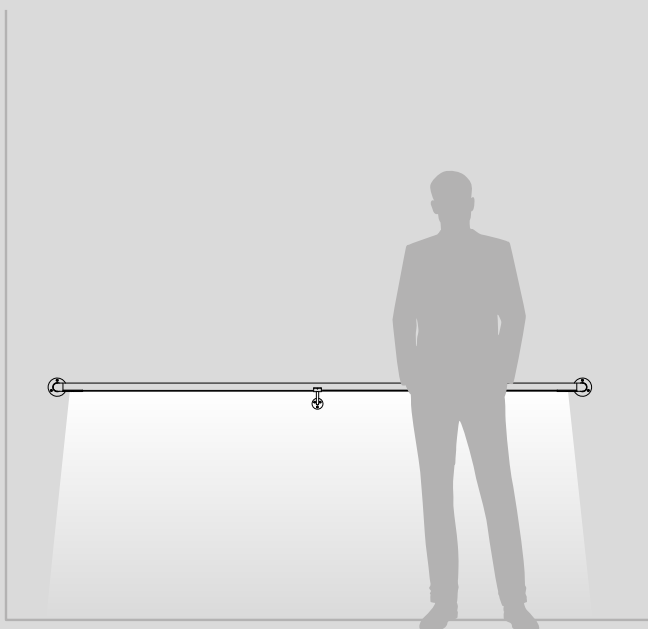

#### DETAILS / DETTAGLI



Internal deflector to increase visual comfort.

Deflettore interno per un maggior comfort visivo.



# HANDRAIL

## SIZE / DIMENSIONI

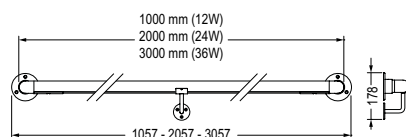

	1000 mm	2000 mm	3000 mm
Total system power	12 W	24 W	36 W
Lumen output max without deflector / senza deflettore	720 lm	1440 lm	2160 lm

## OPTIC / OTTICHE

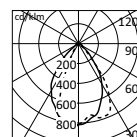

## HOW TO ORDER / COME ORDINARE

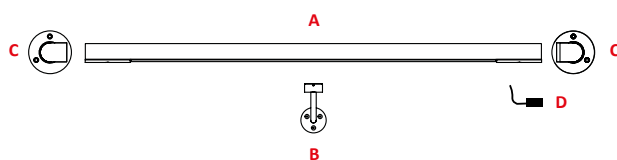

- A** Choose lighting modules with lengths in according to your project  
*Scegli i moduli illuminanti con lunghezze in base al tuo progetto*
- B** Intermediate bracket. For quantity please contact our technical staff  
*Per determinare la quantità contatta il nostro staff tecnico*
- C** End brackets / *Staffe finali*
- D** Remote driver / *Driver remoto*

## PRODUCT CODES / CODICI PRODOTTO

**5 1 0 1 - 1 0 0 1 2 - 8 3 2 4 V - B S**

PRODUCT PRODOTTO	DIMENSIONS DIMENSIONI	POWER POTENZA	LIGHTING COLORS COLORI DELLA LUCE	VOLTAGE VOLTAGGIO	FINISH FINITURE
5101 = HANDRAIL IP67	100 = 1000mm 200 = 2000mm 300 = 3000mm	12 = 12W/m	83 = 3000K CRI>80 84 = 4000K CRI>80	24V 48V	BS = BRUSHED STAINLESS STEEL

# UNDERWATER



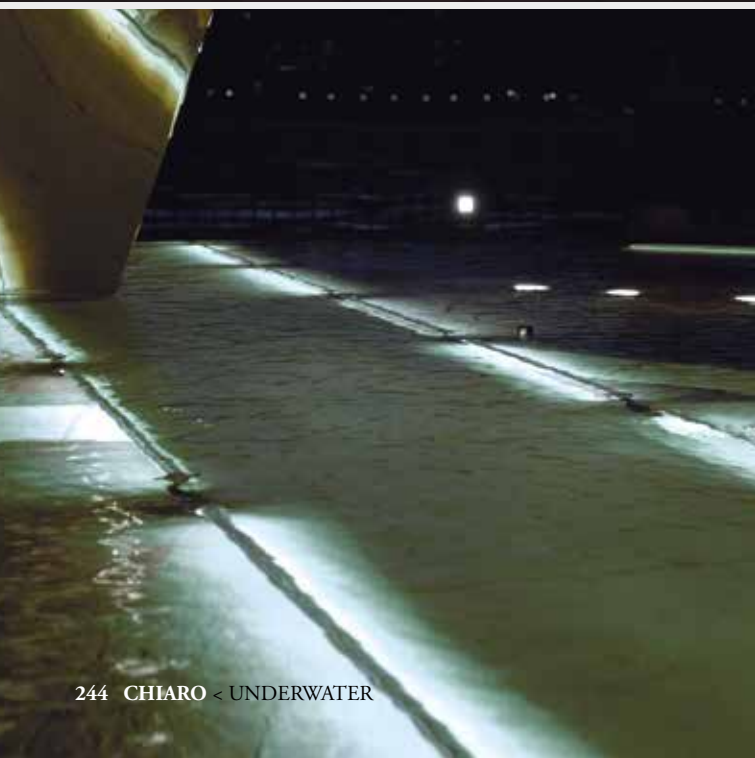

◆ | IP68 | IK10 | CE | 

IS

#### ENVIRONMENTS

Façades and architectural works, wellness, hallway, leisure areas, retail areas, industrial areas, places of worship.

#### PHYSICAL FEATURES

Body: Internal structure made of natural anodised extruded aluminium.

Diffuser: PC with anti-aging UV rays

Screws: AISI 316 stainless steel

Seals: Silicone Rubber

#### ELECTRICAL FEATURES

Driver: Remote ON-OFF or DALI

Voltage: 24V-DC

Wiring: Complete with pre-wired and tested watertight cable (L=2500mm).

#### SOURCES

LED 4000K CRI>80 3000K CRI>80

MacAdam: Step 3

Lifetime: 50.000h L80B50 (Ta=25°C)

#### PERFORMANCE

Up to: 102 lm/W

#### CONTESTI

Facciate e architetture, wellness, spazi d'accesso, intrattenimento, vendita e commercio, industria, luoghi di culto.

#### CARATTERISTICHE FISICHE

Corpo: Struttura interna in estruso di alluminio anodizzato naturale.

Diffusore: PC con anti invecchiamento ai raggi UV

Viteria: inox AISI 316

Guarnizioni: Gomma ai siliconi.

#### CARATTERISTICHE ELETTRICHE

Driver: Remoto ON-OFF o DALI

Tensione: 24V-DC

Cablaggio: Completo di spezzone di cavo già collegato e collaudato a tenuta (L=2500mm).

#### SORGENTI

LED 4000K CRI>80 3000K CRI>80

MacAdam: Step 3

Durata: 50.000h L80B50 (Ta=25°C)

#### PERFORMANCE

Fino a: 102 lm/W

#### OPTIC / OTTICHE

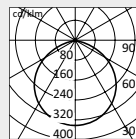

DIRECT

#### OPTIONAL ACCESSORIES

##### ACCESSORI OPZIONALI



Pair of 316L AISI stainless steel brackets for ceiling/wall/floor installation (not walk-over).

Coppia di staffe in acciaio INOX AISI 316L per fissaggio a plafone/parete/terra (non calpestabile).



# CHIARO Ø30

## SIZE / DIMENSIONI

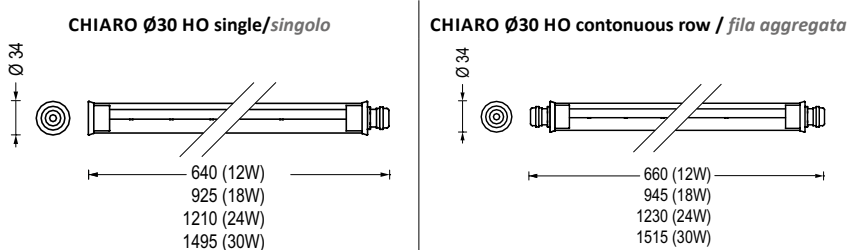

Total system power max

25W

Lumen output max

2562 lm

## CONFIGURATIONS / CONFIGURAZIONI

### CHIARO Ø30 Continuous row / Fila aggregata

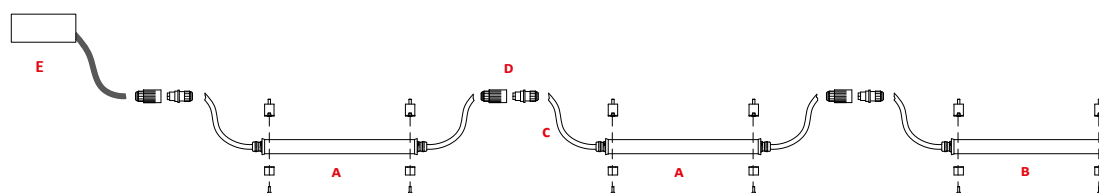

- A CHIARO Continuous / Continuo
- B CHIARO Single / Singolo

Included / Incluso

- C CHIARO Continuous / Continuo  
2 cables / 2 cavi H05RN-F  
(L=2500mm)

- CHIARO Single / Singolo  
1 cables / 1 cavi H05RN-F  
(L=2500mm)

Not included / non inclusi:

- D Connector / Connettore

- E Remote driver / Driver remoto

## PRODUCT CODES / CODICI PRODOTTO

**1 0 7 K L 1 3 7**

PRODUCT PRODOTTO	TYPOLOGY TIPOLOGIA	LIGHTING COLOR COLORI DELLA LUCE	LENGTHS LUNGHEZZE
107 = CHIARO underwater	KL = SINGLE/SINGOLO KM = CONTINUOUS ROW/FILA AGGREGATA	11 = 4000K CRI>80 13 = 3000K CRI>80	7 = 640 or 660 mm (12W) 8 = 925 or 945 mm (18W) 9 = 1210 or 1230 mm (24W) 0 = 1495 or 1515 mm (30W)



◆ IP68 - 10m | IK08 | CE



#### ENVIRONMENTS

Urban landscape, wellness, hallway.

#### PHYSICAL FEATURES

Body: Injection moulded high stress resistant composite technopolymer niche and floodlight.

Fixing: Stainless steel adaptable springs

Seals: Resin sealed luminaire

#### ELECTRICAL FEATURES

Driver: Remote ON-OFF

Voltage: 12V

#### SOURCES

LED 10.000K CRI>70 3000K CRI>80

#### PERFORMANCE

Up to: 67 lm/W

#### CONTESTI

Aree urbane/verdi, wellness, spazi d'accesso.

#### CARATTERISTICHE FISICHE

Corpo: Parti componenti stampate ad iniezione in tecnopolimeri compositi ad alta resistenza.

Fissaggio: Molle adattabili in acciaio inossidabile

Guarnizioni: Corpo illuminante resinato

#### CARATTERISTICHE ELETTRICHE

Driver: Remoto ON-OFF

Tensione: 12V

#### SORGENTI

LED 10.000K CRI>70 3000K CRI>80

#### PERFORMANCE

Fino a: 67 lm/W

#### OPTIONAL ACCESSORIES ACCESSORI OPZIONALI



Niche for fibreglass or vinyl liner pool installation.  
Cassaforma per piscine in fibra di vetro o viniliche.

#### INSTALLATION FLEXIBILITY FLESSIBILITÀ D'INSTALLAZIONE

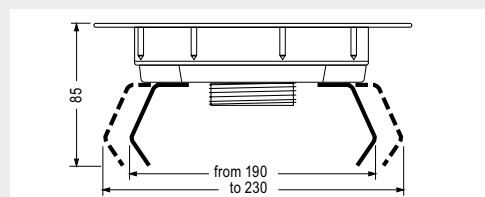





# TARZAN

## SIZE / DIMENSIONI

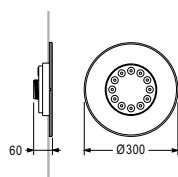

Total system power	18 W
Lumen output max	1200 lm

## OPTIC / OTTICHE

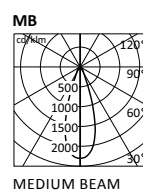

## PRODUCT CODES / CODICI PRODOTTO

**D 17 / 3 - 83 MB - DN**

PRODUCT PRODOTTO	SIZE DIMENSIONI	LIGHTING COLORS COLORI DELLA LUCE	BEAMS FASCI	FINISH FINITURE
D17 = TARZAN underwater	3 = Ø 300mm (18W)	83 = 3000K CRI>80 71 = 10000K CRI>70	MB = MEDIUM BEAM	DN = WHITE SS = STAINLESS STEEL

# POLES



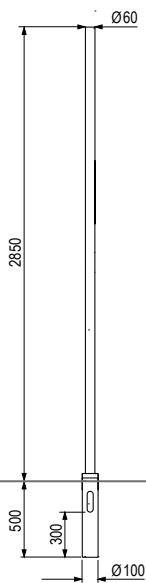

**D43/P300-GR**

Extruded anodized aluminum pole Ø60mm, height above ground level 3 m.  
**GR GRAPHITE**

*Palo in alluminio estruso anodizzato Ø60mm, altezza 3 m fuori terra.  
 GR GRAPHITE*

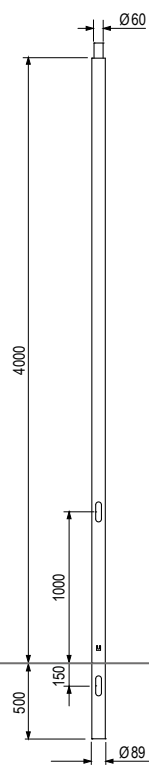

**8PTA40608931V-GR**

Tapered pole, height above ground level 4m. Complete with shunt terminal block. Hot zinc coated and painted  
**GR GRAPHITE**

*Palo rastremato, altezza fuori terra 4m. Completo di morsettiera di derivazione. Zincato a caldo e verniciato  
 GR GRAPHITE*

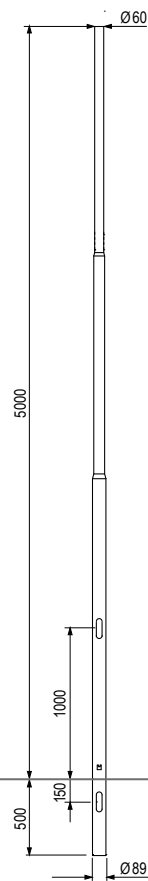

**8PRA50608931V-GR**

Tapered pole, height above ground level 5m. Complete with shunt terminal block. Hot zinc coated and painted  
**GR GRAPHITE**

*Palo rastremato, altezza fuori terra 5m. Completo di morsettiera di derivazione. Zincato a caldo e verniciato  
 GR GRAPHITE*

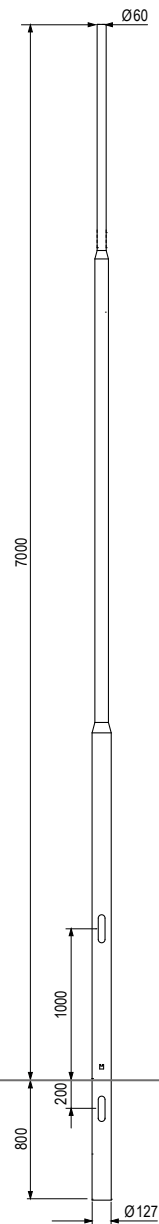

**8PRA7060C731V-GR**

Tapered pole, height above ground level 7m. Complete with shunt terminal block. Hot zinc coated and painted  
**GR GRAPHITE**

*Palo rastremato, altezza fuori terra 7m. Completo di morsettiera di derivazione. Zincato a caldo e verniciato  
 GR GRAPHITE*

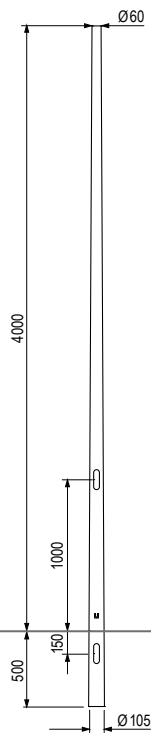

**8PCA4060A531V-GR**

Cone-shaped pole upper,  
height above ground level 4 m.  
Complete with shunt terminal block.  
Hot zinc coated and painted.

**GR GRAPHITE**

*Palo a forma tronco conica,  
altezza fuori terra 4 m.  
Completo di morsettiera di derivazione.  
Zincato a caldo e verniciato.  
GR GRAPHITE*

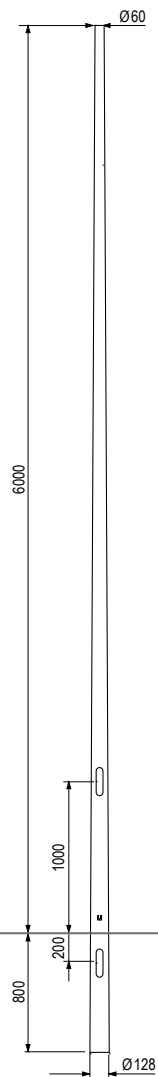

**8PCA6060C831V-GR**

Cone-shaped pole upper,  
height above ground level 6 m.  
Complete with shunt terminal block.  
Hot zinc coated and painted.

**GR GRAPHITE**

*Palo a forma tronco conica,  
altezza fuori terra 6 m.  
Completo di morsettiera di derivazione.  
Zincato a caldo e verniciato.  
GR GRAPHITE*

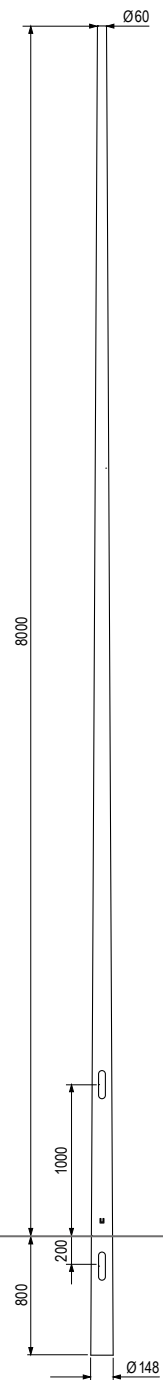

**8PCA8060E831V-GR**

Cone-shaped pole upper,  
height above ground level 8 m.  
Complete with shunt terminal block.  
Hot zinc coated and painted.

**GR GRAPHITE**

*Palo a forma tronco conica,  
altezza fuori terra 8 m.  
Completo di morsettiera di derivazione.  
Zincato a caldo e verniciato.  
GR GRAPHITE*

# PROFILES

CHANNEL 25	p. 260
EMY 32	p. 262
EMY 44	p. 264
GIO' 10	p. 266
GIO' 15	p. 268
GIO' 25	p. 270
PELLY GIO' 10	p. 272
PELLY GIO' 15	p. 274
PELLY GIO' 25	p. 276



**All our products  
are made by us,  
here in Italy.**

**Tutto i nostri prodotti  
sono fatti da noi,  
in Italia.**





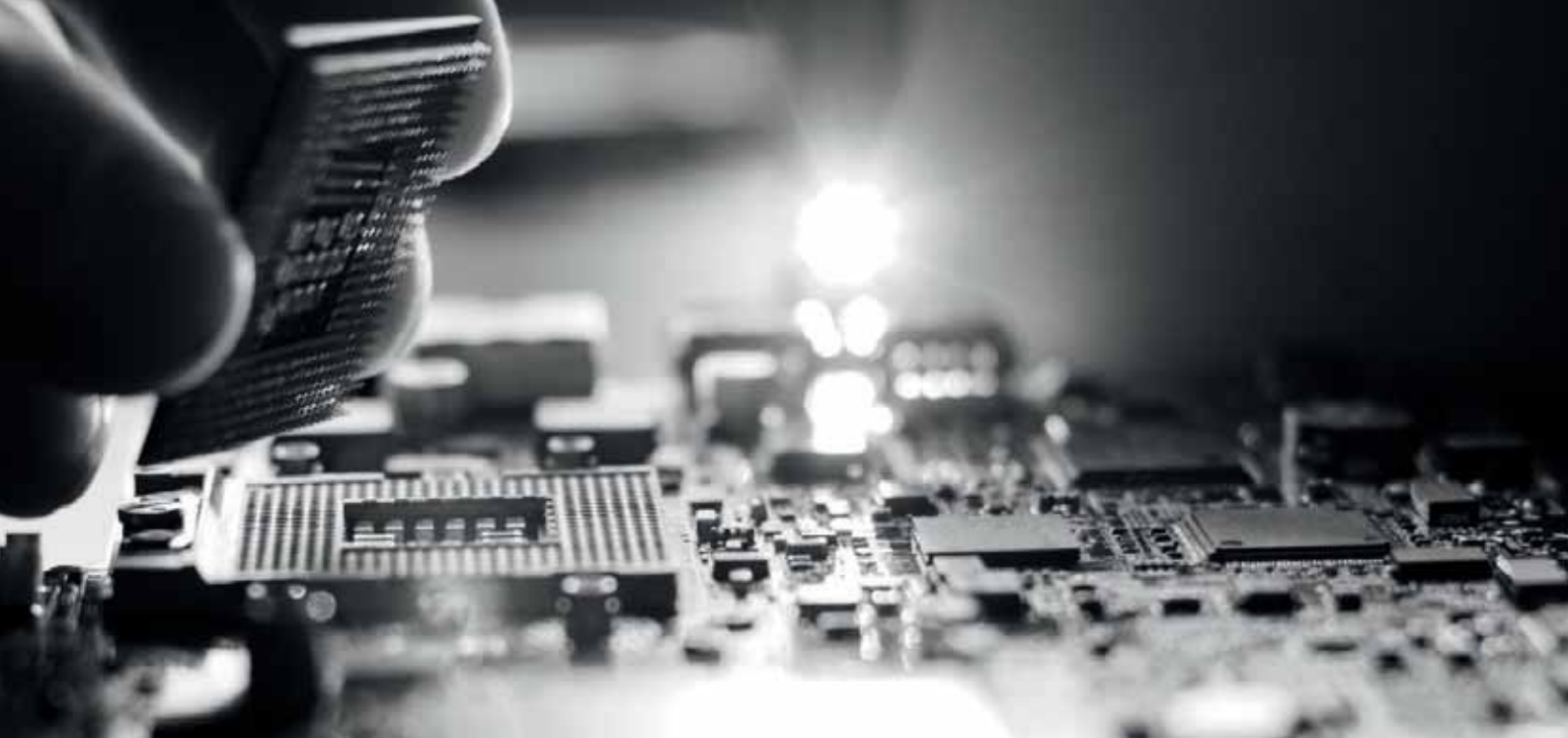

# POWER (W/m)



--- PROFILES INDOOR

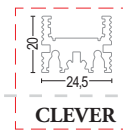

**CLEVER**

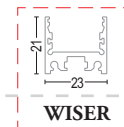

**WISER**

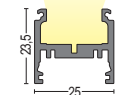

**CHANNEL 25**

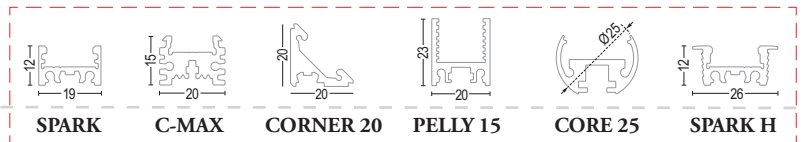

**SPARK**

**C-MAX**

**CORNER 20**

**PELLY 15**

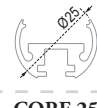

**CORE 25**

**SPARK H**

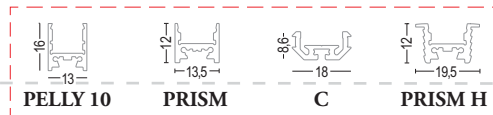

**PELLY 10**

**PRISM**

**C**

**PRISM H**

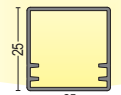

**GIO' 25**



**CORNER 13**



**GIO' 15**

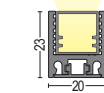

**PELLYGIO' 15**



**GIO' 10**



**PELLYGIO' 10**

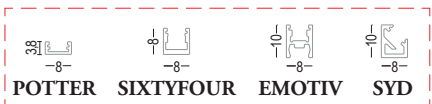

**POTTER**

**SIXTYFOUR**

**EMOTIV**

**SYD**

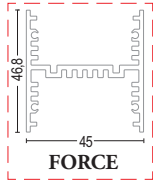

**FORCE**

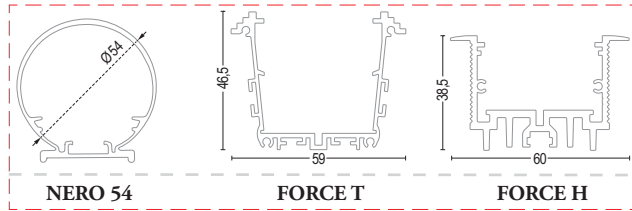

**NERO 54**

**FORCE T**

**FORCE H**

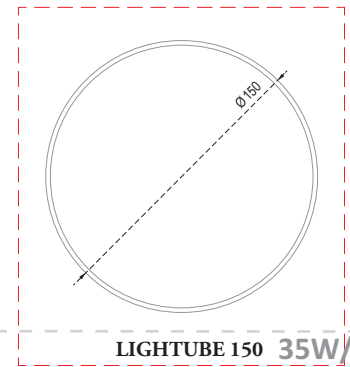

**LIGHTTUBE 150 35W/m**

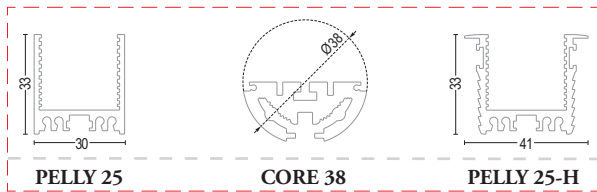

**PELLY 25**

**CORE 38**

**PELLY 25-H**

**30W/m**

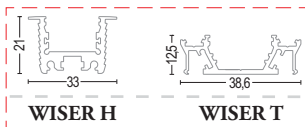

**WISER H**

**WISER T**

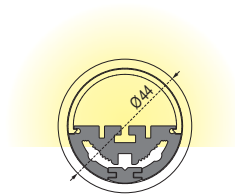

**EMY 44**

**25W/m**

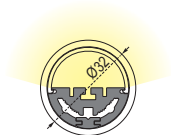

**EMY 32**

**20W/m**

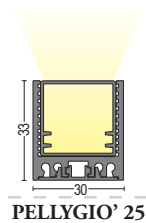

**PELLYGIO' 25**

**15W/m**

**10W/m**

**SIZE** (mm)

## FEATURES

## 48V

**LONG STRECH** Roll longer than 24V version.  
Bobine di lunghezza maggiore rispetto alla versione 24V.

### FLEXIBLE

CRI>80	<p><b>QUEEN 168</b></p> <p>LP 7 W/m MP 12 W/m HP 20 W/m XP 25 W/m</p> <p><b>*POLARIS 168</b> 30 W/m</p>	<p>IP65 available</p>
CRI>90	<p><b>DECOR 168</b></p> <p>LP 7 W/m MP 12 W/m HP 20 W/m XP 25 W/m</p> <p><b>*DECOR POLARIS 168</b> 30 W/m</p>	<p>IP65 available</p>
<p><b>UNIFORMITY</b> CRI&gt;80</p> <p>Short pitch &amp; cutting unit. Passo LED ridotto e modularità aumentata.</p> <p>CRI&gt;90</p>		
<p><b>MICRO</b> CRI&gt;90</p> <p>For very compact profiles. Per profili con dimensioni ridotte.</p>		
<b>RGB</b>	<b>SUNSHINE 96</b>	19 W/m

### SEMI RIGID

CRI>80 and CRI>90	<b>YOUNG 140</b>	LP 7 W/m MP 12 W/m HP 25 W/m
-------------------------	------------------	------------------------------------

### RIGID

CRI>80 and CRI>90 and DYNAMIC WHITE	<b>KING 112 S</b>	23 W/m
	<b>*KING 112</b>	35 W/m
	<b>*KING DW 112 + 112</b>	23 + 23 W/m

CRI>80  
with lenses

48V

24V

\*Available indoor versions:  
Disponibili versioni indoor:

POLARIS 168	DECOR 168
DECOR POLARIS 168	DECOR 216
KING 112	KING 112
KING DW 112 + 112	KING DW 112 + 112
	KING DW 56

# 24V

<b>EVO 168</b>	LP	7 W/m	IP65 available
	MP	12 W/m	
	HP	20 W/m	
	XP	25 W/m	

<b>*DECOR 168</b>	LP	7 W/m	IP65 available
	MP	12 W/m	
	HP	20 W/m	
	XP	25 W/m	

<b>EVO 216</b>	15 W/m
<b>UNIFORM 288</b>	19 W/m

<b>*DECOR 216</b>	15 W/m
-------------------	--------

<b>MICRODECOR 180</b>	9,6 W/m
-----------------------	---------

<b>SUNSHINE 72</b>	14,4 W/m
<b>SUNSHINE 96</b>	19 W/m

<b>YOUNG 140</b>	LP	7 W/m
	MP	12 W/m
	HP	25 W/m

<b>KING 112S</b>	23 W/m
<b>*KING 112</b>	35 W/m
<b>*KING DW 112 + 112</b>	23 + 23 W/m

<b>KING 56S</b>	17 W/m
<b>KING 56</b>	23 W/m
<b>*KING DW 56</b>	17 + 17 W/m

<b>IRON 6</b>	9 W/m module 280 mm
---------------	---------------------

## FLEXIBLE

## SEMI RIGID

## RIGID



## INSTALLATION / INSTALLAZIONE



SUSPENDED / *SOSPESO*



CEILING / *PLAFONE*



WALL / *PARETE*

## CABLE OUTLET / USCITA CAVO

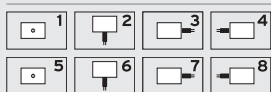

## RESINABLE / RESINABILE



Channel 25 is a aluminum profile (25x25 mm) with the possibility to use standard strips dispersing up to 25W power. The cap makes it possible to orient the power cable in the 4 possible positions (front exit, lower exit, right exit, left exit), without drilling into the profile. The profile can also be resined in order to obtain an IP65 rating. By inserting the back profile, you can use all of the Pelly 25 accessories (magnets, springs, suspension, etc.). A new spring has been designed to fit the profile to the ceiling, allowing the free passage of further cables for any additional connections required. The dimensions of Channel (25x25 mm) allow you to insert it inside the Pelly 25 and use it as an outer casing.

*Channel 25 è un profilo in alluminio (25x25 mm) con la possibilità di poter dissipare strip standard fino alla potenza 25W. Il tappo, permette di orientare il cavo di alimentazione nelle 4 posizioni possibili (Uscita Frontale, Uscita Inferiore, uscita DX, Uscita SX), senza forare il profilo. Il profilo permette di essere resinato in modo da ottenere il grado IP65. Con l'inserimento del profilo posteriore è possibile utilizzare tutti gli accessori del Pelly 25 (calamite, molle, sospensione, ecc.). È stata progettata una nuova molla che permette di fissare il profilo a plafone, consentendo il transito di ulteriori cavi di collegamento per connessioni supplementari. Le dimensioni del Channel (25x25 mm) permettono di inserirlo all'interno del Pelly 25 e utilizzarlo come controcassa.*

## ACCESSORIES / ACCESSORI



Back profile.  
*Profilo posteriore.*  
**EAWN6000V0T**

W  G  N



Frosted diffuser.  
*Schermo acidato.*  
**SCC341B**



Clear diffuser.  
*Schermo trasparente.*  
**SCB341B**

SF (no hole) F (with hole)



End cap kit.  
*Kit testate di chiusura.*

**ST3602K** INFER.  
**ST3603K** ALIM. FRONT  
**ST3604K** ALIM. DX  
**ST3605K** ALIM. SX  
**ST3606K** ALIM. PASS  
 W  G  N  
Special color



Mounting clip kit.  
*Kit graffetta di montaggio.*

**ST3600K**



Magnet + plate kit.  
*Kit magnete + lamina.*

**ST0431K**



Magnet kit for metallic structures.  
*Kit magnete per strutture metalliche.*

**CANEQ2V0**



Fairlead rose.  
*Rosone passacavo.*

**ST0034K**

W  G  N



Low adjustable bracket kit.  
*Kit staffe orientabili basse.*  
**ST1607K**

W  G  N



Medium adjustable bracket kit.  
*Kit staffe orientabili medie.*  
**ST1608K**

W  G  N



High adjustable bracket kit.  
*Kit staffe orientabili alte.*  
**ST1609K**

W  G  N



Standard profile suspension kit.  
*Kit sospensione profili standard.*

**ST9016K - 3 m**  
**ST9018K - 5 m**



Medium profile suspension kit.  
*Kit sospensione profili intermedio.*

**ST9017K - 3 m**  
**ST9019K - 5 m**



Kit of two safety cords.  
*Kit due cordini di sicurezza.*

**ST0038K**



# CHANNEL 25

## PROFILE / PROFILO

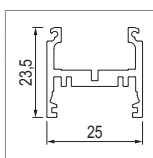

DESCRIPTION / DESCRIZIONE	PART NUMBER / CODICE	FINISH / FINITURA		
		W	G	N
<b>Channel 25 profile</b> <i>Profilo Channel 25</i>	<b>EAWN6000V0</b>			

## STRIPS COMPATIBILITY / STRIP COMPATIBILI



DESCRIPTION DESCRIZIONE	POWER POTENZA	COLOUR COLORE	PAGE PAGINA	DESCRIPTION DESCRIZIONE	POWER POTENZA	COLOUR COLORE	PAGE PAGINA
Queen 168 LP / 48 Vdc	7 W/m	2200-5700K	280	Microdecor 180 / 24 Vdc	9 W/m	2200-6000K	296
Queen 168 MP / 48 Vdc	12 W/m	2200-5700K	281	Sunshine 72 / 24 Vdc	14,4 W/m	RGB	304
Queen 168 HP / 48 Vdc	20 W/m	2200-5700K	283	Sunshine 96 / 24 Vdc / 48 Vdc	19 W/m	RGB	304
Queen 168 XP / 48 Vdc	25 W/m	2200-5700K	283	King 56 / 24 Vdc	23 W/m	2200-5700K	308
Decor 168 LP / 24 Vdc / 48 Vdc	7 W/m	2200-5700K	284-285	King 56S / 24 Vdc	17 W/m	2200-5700K	309
Decor 168 MP / 24 Vdc / 48 Vdc	12 W/m	2200-5700K	286-287	Easy 5050-60 / 24 Vdc	14,4 W/m	2800-6500K	316
Decor 168 HP / 24 Vdc / 48 Vdc	20 W/m	2200-5700K	287	Easy 3528-120 / 24 Vdc	9,6 W/m	2700-6500K	317
Decor 168 XP / 24 Vdc / 48 Vdc	25 W/m	2200-5700K	288	Easy 3528-120 colors / 24 Vdc	9,6 W/m	color	318
Decor 216 MP / 24 Vdc	15 W/m	2200-5700K	289	Micro Easy 3528-120 colors / 24 Vdc	9,6 W/m	color	319
Evo 216 MP / 24 Vdc	15 W/m	2200-5700K	290	Easy 2835-96 / 24 Vdc	20 W/m	2700-6500K	320
Uniform 288 / 24 Vdc	19 W/m	2200-5700K	290	Easy 3528-120 DW / 24 Vdc	20 W/m	LED DW	320
Evo 168 LP / 24 Vdc	7 W/m	2200-5700K	292	Easy 3528-180 / 24 Vdc	15 W/m	2700-6500K	321
Evo 168 MP / 24 Vdc	12 W/m	2200-5700K	294	Easy 3528-120 RGBW / 24 Vdc	20 W/m	RGBW	322
Evo 168 HP / 24 Vdc	20 W/m	2200-5700K	294-295	Easy 5050-60 RGB / 24 Vdc	14,4 W/m	RGB	322
Evo 168 XP / 24 Vdc	25 W/m	2200-5700K	295				

All strips are IP00.  
Tutte le strip sono IP00.



#### INSTALLATION / INSTALLAZIONE



SUSPENDED / *SOSPESO*



CEILING / *PLAFONE*



WALL / *PARETE*

#### CABLE OUTLET / *USCITA CAVO*

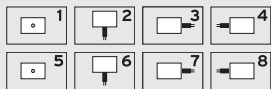

#### RESINABLE / *RESINABILE*



**Emy 32 is a polycarbonate tube** with an external diameter of 32 mm and a thickness of 4 mm, complete with AISI316L steel caps, **allows the housing of various types of strips for a maximum power of 20 W/m.** The fixing brackets have been made as accessories, with the possibility of rotating the profile and locking in the desired position. In addition, there is an accessory available that allows the unit to be suspended.

*Emy 32 è un tubo in policarbonato del diametro esterno di 32 mm dello spessore di 4 mm, completo con tappi in acciaio AISI316L, permette alloggiare varie tipologie di strip per una potenza massima di 20 W/m.*

*Come accessori sono state realizzate le staffe di fissaggio, con la possibilità di ruotare il profilo e bloccare nella posizione voluta.*

*Inoltre è disponibile anche l'accessorio per essere utilizzato come sospensione.*

#### ACCESSORIES / *ACCESSORI*



Mounting clip kit.  
*Kit fissaggio parete.*

ST3506K ● G



Suspension kit.  
*Kit sospensione.*

ST3509K - 3 m ● G  
ST3510K - 5 m ● G





# EMY 32

## PROFILE / PROFILO

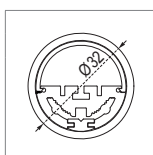

DESCRIPTION / DESCRIZIONE	PART NUMBER / CODICE	WIDTH / LUNGHEZZA	FINISH / FINITURA		
			W	G	N
<b>Emy 32 opal profile</b> <i>Profilo opale Emy 32</i>	<b>ST3511K*</b> <b>ST3521K*</b> <b>ST3531K*</b>	<b>1000 mm</b> <b>2000 mm</b> <b>3000 mm</b>	—	●	—

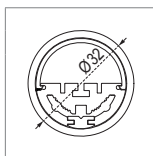

DESCRIPTION / DESCRIZIONE	PART NUMBER / CODICE	WIDTH / LUNGHEZZA	FINISH / FINITURA		
			W	G	N
<b>Emy 32 clear profile</b> <i>Profilo trasparente Emy 32</i>	<b>ST3515K*</b> <b>ST3525K*</b> <b>ST3535K*</b>	<b>1000 mm</b> <b>2000 mm</b> <b>3000 mm</b>	—	●	—

Price for version with integral looping line at request. **ATTENTION:** order strip separately; for custom lengths please contact our Sales Department. \*  
Prezzo a richiesta per versione con linea passante integrata. **ATTENZIONE:** ordinare la strip separatamente; per lunghezze custom contattare il nostro Ufficio Commerciale.

## STRIPS COMPATIBILITY / STRIP COMPATIBILI



DESCRIPTION DESCRIZIONE	POWER POTENZA	COLOUR COLORE	PAGE PAGINA	DESCRIPTION DESCRIZIONE	POWER POTENZA	COLOUR COLORE	PAGE PAGINA
Queen 168 LP / 48 Vdc	7 W/m	2200-5700K	280	Sunshine 72 / 24 Vdc	14,4 W/m	RGB	304
Queen 168 MP / 48 Vdc	12 W/m	2200-5700K	281	Sunshine 96 / 24 Vdc / 48 Vdc	19 W/m	RGB	304
Queen 168 HP / 48 Vdc	20 W/m	2200-5700K	283	King 56S / 24 Vdc	17 W/m	2200-5700K	309
Decor 168 LP / 24 Vdc / 48 Vdc	7 W/m	2200-5700K	284-285	Easy 5050-60 / 24 Vdc	14,4 W/m	2800-6500K	316
Decor 168 MP / 24 Vdc / 48 Vdc	12 W/m	2200-5700K	286-287	Easy 3528-120 / 24 Vdc	9,6 W/m	2700-6500K	317
Decor 168 HP / 24 Vdc / 48 Vdc	20 W/m	2200-5700K	287	Easy 3528-120 colors / 24 Vdc	9,6 W/m	color	318
Decor 216 MP / 24 Vdc	15 W/m	2200-5700K	289	Micro Easy 3528-120 colors / 24 Vdc	9,6 W/m	color	319
Evo 216 MP / 24 Vdc	15 W/m	2200-5700K	290	Easy 2835-96 / 24 Vdc	20 W/m	2700-6500K	320
Uniform 288 / 24 Vdc	19 W/m	2200-5700K	290	Easy 3528-120 DW / 24 Vdc	20 W/m	LED DW	320
Evo 168 LP / 24 Vdc	7 W/m	2200-5700K	292	Easy 3528-180 / 24 Vdc	15 W/m	2700-6500K	321
Evo 168 MP / 24 Vdc	12 W/m	2200-5700K	294	Easy 3528-120 RGBW / 24 Vdc	20 W/m	RGBW	322
Evo 168 HP / 24 Vdc	20 W/m	2200-5700K	294-295	Easy 5050-60 RGB / 24 Vdc	14,4 W/m	RGB	322
Microdecor 180 / 24 Vdc	9 W/m	2200-6000K	296				

All strips are IP00.  
Tutte le strip sono IP00.



#### INSTALLATION / INSTALLAZIONE

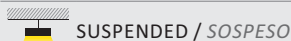

SUSPENDED / *SOSPESO*

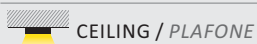

CEILING / *PLAFONE*



WALL / *PARETE*

#### CABLE OUTLET / USCITA CAVO

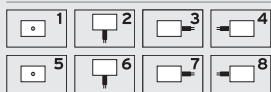

#### RESINABLE / RESINABILE



**Emy 44 is a polycarbonate tube with 44 mm external diameter and 4 mm thickness, complete with AISI316L steel caps, allows you to install various types of strips up to a maximum power of 25 W/m (except Iron 6).**

The fixing brackets have been made as accessories, with the possibility of rotating the profile and locking in the desired position.

In addition, there is an accessory available that allows the unit to be suspended.

*Emy 44 è un tubo in policarbonato del diametro esterno di 44 mm dello spessore di 4 mm, completo con tappi in acciaio AISI316L, permette di installare varie tipologie di strip per una potenza massima di 25 W/m (eccetto Iron 6).*

*Come accessori sono state realizzate le staffe di fissaggio, con la possibilità di ruotare il profilo e bloccare nella posizione voluta.*

*Inoltre è disponibile l'accessorio per l'utilizzo in sospensione.*

#### ACCESSORIES / ACCESSORI



Mounting clip kit.  
*Kit fissaggio parete.*

ST4402K ● G



Suspension kit.  
*Kit sospensione.*

ST4408K - 3 m ● G

ST4409K - 5 m ● G



# EMY 44

## PROFILE / PROFILO

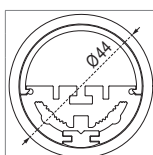

DESCRIPTION / DESCRIZIONE	PART NUMBER / CODICE	WIDTH / LUNGHEZZA	FINISH / FINITURA		
			W	G	N
<b>Emy 44 opal profile</b> <i>Profilo opale Emy 44</i>	<b>ST4410K*</b> <b>ST4420K*</b> <b>ST4430K*</b>	<b>1000 mm</b> <b>2000 mm</b> <b>3000 mm</b>	—	●	—

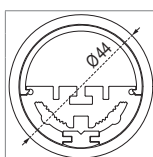

DESCRIPTION / DESCRIZIONE	PART NUMBER / CODICE	WIDTH / LUNGHEZZA	FINISH / FINITURA		
			W	G	N
<b>Emy 44 clear profile</b> <i>Profilo trasparente Emy 44</i>	<b>ST4415K*</b> <b>ST4425K*</b> <b>ST4435K*</b>	<b>1000 mm</b> <b>2000 mm</b> <b>3000 mm</b>	—	●	—

Price for version with integral looping line at request. **ATTENTION:** order strip separately; for custom lengths please contact our Sales Department. \*  
Prezzo a richiesta per versione con linea passante integrata. **ATTENZIONE:** ordinare la strip separatamente; per lunghezze custom contattare il nostro Ufficio Commerciale.

## STRIPS COMPATIBILITY / STRIP COMPATIBILI



DESCRIPTION DESCRIZIONE	POWER POTENZA	COLOUR COLORE	PAGE PAGINA	DESCRIPTION DESCRIZIONE	POWER POTENZA	COLOUR COLORE	PAGE PAGINA
Queen 168 LP / 48 Vdc	7 W/m	2200-5700K	280	Sunshine 72 / 24 Vdc	14,4 W/m	RGB	304
Queen 168 MP / 48 Vdc	12 W/m	2200-5700K	281	Sunshine 96 / 24 Vdc / 48 Vdc	19 W/m	RGB	304
Queen 168 HP / 48 Vdc	20 W/m	2200-5700K	283	King 56 / 24 Vdc	23 W/m	2200-5700K	308
Queen 168 XP / 48 Vdc	25 W/m	2200-5700K	283	King 56S / 24 Vdc	17 W/m	2200-5700K	309
Decor 168 LP / 24 Vdc / 48 Vdc	7 W/m	2200-5700K	284-285	King 112S / 24 Vdc / 48 Vdc	23 W/m	2200-5700K	310-311
Decor 168 MP / 24 Vdc / 48 Vdc	12 W/m	2200-5700K	286-287	Iron 6 / 24 Vdc	30 W/m	2700-5700K	312
Decor 168 HP / 24 Vdc / 48 Vdc	20 W/m	2200-5700K	287	Easy 5050-60 / 24 Vdc	14,4 W/m	2800-6500K	316
Decor 168 XP / 24 Vdc / 48 Vdc	25 W/m	2200-5700K	288	Easy 3528-120 / 24 Vdc	9,6 W/m	2700-6500K	317
Decor 216 MP / 24 Vdc	15 W/m	2200-5700K	289	Easy 3528-120 colors / 24 Vdc	9,6 W/m	color	318
Evo 216 MP / 24 Vdc	15 W/m	2200-5700K	290	Micro Easy 3528-120 colors / 24 Vdc	9,6 W/m	color	319
Uniform 288 / 24 Vdc	19 W/m	2200-5700K	290	Easy 2835-96 / 24 Vdc	20 W/m	2700-6500K	320
Evo 168 LP / 24 Vdc	7 W/m	2200-5700K	292	Easy 3528-120 DW / 24 Vdc	20 W/m	LED DW	320
Evo 168 MP / 24 Vdc	12 W/m	2200-5700K	294	Easy 3528-180 / 24 Vdc	15 W/m	2700-6500K	321
Evo 168 HP / 24 Vdc	20 W/m	2200-5700K	294-295	Easy 3528-120 RGBW / 24 Vdc	20 W/m	RGBW	322
Evo 168 XP / 24 Vdc	25 W/m	2200-5700K	295	Easy 5050-60 RGB / 24 Vdc	14,4 W/m	RGB	322
Microdecor 180 / 24 Vdc	9 W/m	2200-6000K	296				

All strips are IP00.  
Tutte le strip sono IP00.



## INSTALLATION / INSTALLAZIONE

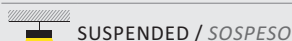

SUSPENDED / *SOSPESO*



CEILING / *PLAFONE*

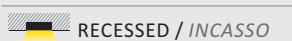

RECESSED / *INCASSO*



WALL / *PARETE*

## CABLE OUTLET / USCITA CAVO

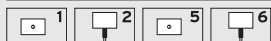

## RESINABLE / RESINABILE



**Giò 10 is a flexible opal polycarbonate profile** (check the corner radius) (10x10 mm).  
Giò 10 allows a luminous flux on three sides. Giò 10 can be installed magnetically on metallic surfaces or housed inside the Pelly 10 profile. Giò 10 is also available in IP65 to be used in damp and outdoor environments.

*Giò 10 è un profilo in policarbonato opale flessibile (verificare il raggio di curvatura) (10x10 mm). Giò 10 consente un flusso luminoso su tre lati. Giò 10 può essere installato a calamita su superfici metalliche o alloggiato all'interno del profilo Pelly 10. Giò 10 è disponibile anche in IP65 per l'utilizzo in ambienti umidi ed esterni.*

## ACCESSORIES / ACCESSORI



IP65 cover cap.  
*Copri tappo IP65.*

ST0645W  
ST0645  
 W  Stainless steel



IP65 end cap kit.  
*Kit testate di chiusura IP65.*

ST0636K = F + SF  
ST0639K = F + F



IP44 end cap kit.  
*Kit testate di chiusura IP44.*

ST0600K



IP65 end cap kit with cover caps (4 pcs).  
*Kit testate di chiusura IP65 con copritestate (4 pz).*

ST0637K  
Power cable at bottom.  
*Cavo di alimentazione in basso.*



IP65 end cap kit with adjustable cover caps (4 pcs).  
*Kit testate di chiusura orientabili IP65 con copritestate (4 pz).*

ST0638K = F + F



End cap.  
*Testata di chiusura.*

TVFGGASTV0W  W



Curvy connection system.  
*Raccordo Curvy.*

ST0687KW  W



Support kit (2 pcs.).  
*Kit supporto (2 pz.).*

ST0604K



External plate kit.  
*Kit lamina esterna.*

ST0615KW  W



Magnet.  
*Magnete.*

CANE6X1,5X20



Slim bracket kit.  
*Kit staffa slim.*

ST0664KW  
ST0664K  
 W  Stainless steel



45° flush-mounting support for wooden structures.  
*Controcassa 45° per supporti in legno.*

ST0665W\*  W

\* **WARNING!**  
Not suitable for applications in direct contact with water.  
**ATTENZIONE!**  
Non adatto per applicazioni a diretto contatto con l'acqua.



Curvy suspension.  
*Sospensione Curvy.*

ST0696K - 3 m



Standard profile suspension kit.  
*Kit sospensione profili standard.*

ST9010K - 3 m  
ST9012K - 5 m



Medium profile suspension kit.  
*Kit sospensione profili intermedio.*

ST9011K - 3 m  
ST9013K - 5 m



Direction of light  
*Direzione delle luce*



# GIO' 10

## PROFILE / PROFILO

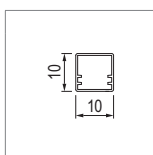

DESCRIPTION / DESCRIZIONE	PART NUMBER / CODICE	FINISH / FINITURA
<b>Giò 10 profile with plate</b> <i>Profilo con lamina Giò 10</i>	<b>ST0626K</b>	—

## STRIPS CHARACTERISTICS / CARATTERISTICHE STRIP

PROFILE / PROFILO	STRIP WIDTH / LARGHEZZA STRIP	MAX DISSIPATION / MASSIMA DISSIPAZIONE
<b>Giò' 10</b>	<b>8 mm</b>	<b>9 W/mt</b>

## STRIPS COMPATIBILITY / STRIP COMPATIBILI



DESCRIPTION / DESCRIZIONE	POWER / POTENZA	COLOUR / COLORE	PAGE / PAGINA
<b>Young 140 LP / 24 Vdc / 48 Vdc</b>	<b>7 W/m</b>	 <b>2200-5700K</b>	<b>298-300</b>

All strips are IP00.  
Tutte le strip sono IP00.



## INSTALLATION / INSTALLAZIONE



SUSPENDED / *SOSPESO*



CEILING / *PLAFONE*



WALL / *PARETE*

## CABLE OUTLET / USCITA CAVO

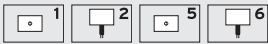

## RESINABLE / RESINABILE



**Giò 15 is a flexible opal polycarbonate profile** (check the corner radius) (15x15 mm).  
Giò 15 allows a luminous flux on three sides. Giò 15 can be installed magnetically on metallic surfaces or housed inside the Pelly 15 profile.  
Giò 15 is also available in IP65 to be used in damp and outdoor environments.

*Giò 15 è un profilo in policarbonato opale flessibile (verificare il raggio di curvatura) (15x15 mm). Giò 15 consente un flusso luminoso su tre lati.*

*Giò 15 può essere installato a calamita su superfici metalliche o alloggiato all'interno del profilo Pelly 15.*

*Giò 15 è disponibile anche in IP65 per l'utilizzo in ambienti umidi ed esterni.*

## ACCESSORIES / ACCESSORI

F (with hole) SF (no hole)



**IP65 end caps.**  
*Kit testate di chiusura IP65.*

**ST0673K = F + SF**  
**ST0674K = F + F**



**IP44 end caps kit.**  
*Kit testate di chiusura IP44.*

**ST0601K**



**Pair of mounting end caps with cover caps (4 pcs.).**  
*Coppia testate fissaggio con copritestate (4 pz.).*

**ST0610K**



**End cap.**  
*Testata di chiusura.*

**TVFGGBSTV0W** |  W



**15 mm bracket kit.**  
*Kit staffa 15 mm.*

**ST0657KW**  
**ST0657K**

W |  Stainless steel



**40 mm bracket kit.**  
*Kit staffa 40 mm.*

**ST0658KW**  
**ST0658K**

W |  Stainless steel



**Slim bracket kit.**  
*Kit staffa slim.*

**ST0659KW**  
**ST0659K**

W |  Stainless steel



**Inside half-corner kit.**  
*Kit semiangolo interno.*

**ST0662KW**  
**ST0662K**

W |  Stainless steel



**Outside corner kit.**  
*Kit angolo esterno.*

**ST0660KW**  
**ST0660K**

W |  Stainless steel



**Flat corner kit.**  
*Kit angolo piano.*

**ST0661KW**  
**ST0661K**

W |  Stainless steel



**Bold bracket kit (30 mm).**  
*Kit staffa (30 mm).*

**ST0641KW**  
**ST0641K**

W |  Stainless steel



**Terminal plug brackets.**  
*Tappo terminale staffe.*

**ST0633W**  
**ST0633**

W |  Stainless steel



**External plate kit.**  
*Kit lamina esterna.*

**ST0616KW** |  W



**Magnet.**  
*Magnete.*

**CANE6X2X20SF1**



**Curvy connection system.**  
*Raccordo Curvy.*

**ST0675W** |  W



**Curvy suspension.**  
*Sospensione Curvy.*

**ST0695K - 3 m**

FLEXIBLE  
◀◀◀◀◀◀◀◀

# GIO' 15

## PROFILE / PROFILO

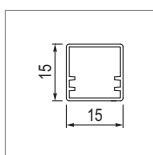

DESCRIPTION / DESCRIZIONE	PART NUMBER / CODICE	FINISH / FINITURA
<b>Gio' 15 profile with plate</b> <i>Profilo con lamina Gio' 15</i>	<b>ST0627K</b>	—

## STRIPS CHARACTERISTICS / CARATTERISTICHE STRIP

PROFILE / PROFILO	STRIP WIDTH / LARGHEZZA STRIP	MAX DISSIPATION / MASSIMA DISSIPAZIONE
<b>Gio' 15</b>	13 mm	12 W/mt

## STRIPS COMPATIBILITY / STRIP COMPATIBILI



DESCRIPTION / DESCRIZIONE	POWER / POTENZA	COLOUR / COLORE	PAGE / PAGINA
<b>Young 140 MP / 24 Vdc / 48 Vdc</b>	12 W/m	 2200-5700K	300-301

All strips are IP00.  
Tutte le strip sono IP00.



## INSTALLATION / INSTALLAZIONE



SUSPENDED / *SOSPESO*



CEILING / *PLAFONE*



WALL / *PARETE*

## CABLE OUTLET / USCITA CAVO

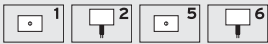

## RESINABLE / RESINABILE



**Giò 25 is a flexible opal polycarbonate profile** (check the corner radius) (25x25 mm). Giò 25 allows a luminous flux on three sides. Giò 25 can be installed magnetically on metallic surfaces or housed inside the Pelly 25 profile. Giò 25 is also available in IP65 to be used in damp and outdoor environments.

*Giò 25 è un profilo in policarbonato opale flessibile (verificare il raggio di curvatura) (25x25 mm). Giò 25 consente un flusso luminoso su tre lati.*

*Giò 25 può essere installato a calamita su superfici metalliche o alloggiato all'interno del profilo Pelly 25. Giò 25 è disponibile anche in IP65 per l'utilizzo in ambienti umidi ed esterni.*

## ACCESSORIES / ACCESSORI

F (with hole) SF (no hole)



**IP65 end caps kit.**  
*Kit testate di chiusura IP65.*  
ST0679K = F + SF  
ST0680K = F + F



**IP44 end caps kit.**  
*Kit testate di chiusura IP44.*  
ST0602K



**End cap.**  
*Testata di chiusura.*  
TVFGGCVT0W  W



**Curvy connection system.**  
*Raccordo Curvy.*  
ST0697W  W



**15 mm bracket kit.**  
*Kit staffa 15 mm.*  
ST0651KW  
ST0651K  
 W  Stainless steel



**40 mm bracket kit.**  
*Kit staffa 40 mm.*  
ST0652KW  
ST0652K  
 W  Stainless steel



**Slim bracket kit.**  
*Kit staffa slim.*  
ST0653KW  
ST0653K  
 W  Stainless steel



**Inside half-corner kit.**  
*Kit semiangolo interno.*  
ST0656KW  
ST0656K  
 W  Stainless steel



**Outside corner kit.**  
*Kit angolo esterno.*  
ST0654KW  
ST0654K  
 W  Stainless steel



**Flat corner kit.**  
*Kit angolo piano.*  
ST0655KW  
ST0655K  
 W  Stainless steel



**Fixing kit.**  
*Kit fissaggio.*  
ST0672KW  
ST0672K  
 W  Stainless steel



**Fixing kit.**  
*Kit fissaggio.*  
ST0682KW  
ST0682K  
 W  Stainless steel



**Small suspending kit.**  
*Kit sospensione intermedio.*  
ST0670KW  W



**Suspending kit.**  
*Kit sospensione.*  
ST0669KW  W



**Standard profile suspension kit.**  
*Kit sospensione profili standard.*  
ST9010K - 3 m  
ST9012K - 5 m



**Medium profile suspension kit.**  
*Kit sospensione profili intermedio.*  
ST9011K - 3 m  
ST9013K - 5 m



**Terminal plug brackets.**  
*Tappo terminale staffe.*  
ST0620W  
ST0620  
 W  Stainless steel



**External plate kit.**  
*Kit lamina esterna.*  
ST0617KW  W



**Magnet kit for metallic structures.**  
*Kit magneti per strutture metalliche.*  
CANELTCV0



**Curvy suspension kit.**  
*Sospensione Curvy.*  
ST0694K - 3 m





**FLEXIBLE**  
◀◀◀◀◀◀◀◀

# GIO' 25

## PROFILE / PROFILO

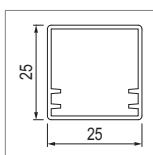

DESCRIPTION / DESCRIZIONE	PART NUMBER / CODICE	FINISH / FINITURA
<b>Giò 25 profile with plate</b> <i>Profilo con lamina Giò 25</i>	<b>ST0628K</b>	—

## STRIPS CHARACTERISTICS / CARATTERISTICHE STRIP

PROFILE / PROFILO	STRIP WIDTH / LARGHEZZA STRIP	MAX DISSIPATION / MASSIMA DISSIPAZIONE
<b>Giò' 25</b>	23 mm	15 W/mt

## STRIPS COMPATIBILITY / STRIP COMPATIBILI



DESCRIPTION / DESCRIZIONE	POWER / POTENZA	COLOUR / COLORE	PAGE / PAGINA
<b>Young 140 HP / 24 Vdc / 48 Vdc</b>	15 W/m	 2200-5700K	302-303

All strips are IP00.  
Tutte le strip sono IP00.



## INSTALLATION / INSTALLAZIONE



SUSPENDED / *SOSPESO*

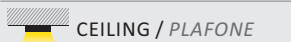

CEILING / *PLAFONE*

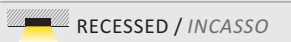

RECESSED / *INCASSO*



WALL / *PARETE*

## CABLE OUTLET / USCITA CAVO



## RESINABLE / RESINABILE



**Pelly Giò 10 is an anodized aluminium and opal flexible polycarbonate profile (13x16 mm).**

Pelly Giò 10 is obtained by combining the Pelly 10 profile with the extruded total white Giò 10 (page 266): the Pelly 10 profile acts as an outer casing of the total white Giò 10 for easy and fast maintenance.

Pelly Giò 10 is also available in IP65 for use in damp and outdoor environments.

*Pelly Giò 10 è un profilo in alluminio anodizzato e policarbonato opale flessibile (13x16 mm). Pelly Giò 10 si ottiene combinando il profilo Pelly 10 con l'estruso total white Giò 10 (pag. 266): il profilo Pelly 10 funge da controcassa del total white Giò 10 per una manutenzione facile e veloce. Pelly Giò 10 è disponibile anche in IP65 per l'utilizzo in ambienti umidi ed esterni.*

## ACCESSORIES / ACCESSORI

F (with hole) SF (no hole) F (with hole) SF (no hole)



**End cap kit.**  
*Kit testate di chiusura.*

**ST1500 = F + SF**

**ST1501 = F + F**

○ W ● G ● N



**IP65 end cap kit.**  
*Kit testate di chiusura IP65.*

**ST1509 = F + SF**

**ST1510 = F + F**

○ W ● G ● N



**Mounting clip kit.**  
*Kit graffetta di montaggio.*

**ST0009K**



**Magnet + plate kit.**  
*Kit magnete + lamina.*

**ST0025K**



**Magnet kit for metallic structures.**  
*Kit magnete per strutture metalliche.*

**CANELTCVO**



**Rear joining plate kit.**  
*Kit lamina giunzione posteriore.*

**ST0010K**



**Low adjustable bracket kit.**  
*Kit staffe orientabili basse.*

**ST0213K**

○ W ● G ● N



**Medium adjustable bracket kit.**  
*Kit staffe orientabili medie.*

**ST0214K**

○ W ● G ● N



**High adjustable bracket kit.**  
*Kit staffe orientabili alte.*

**ST0215K**

○ W ● G ● N



**Vertical 90° joining rear bracket.**  
*Staffa unione barre verticale 90°.*

**ST1425K**



**Standard profile suspension kit.**  
*Kit sospensione profili standard.*

**ST9010K - 3 m**

**ST9012K - 5 m**



**Medium profile suspension kit.**  
*Kit sospensione profili intermedio.*

**ST9011K - 3 m**

**ST9013K - 5 m**



**Kit of two safety cords.**  
*Kit due cordini di sicurezza.*

**ST0038K**

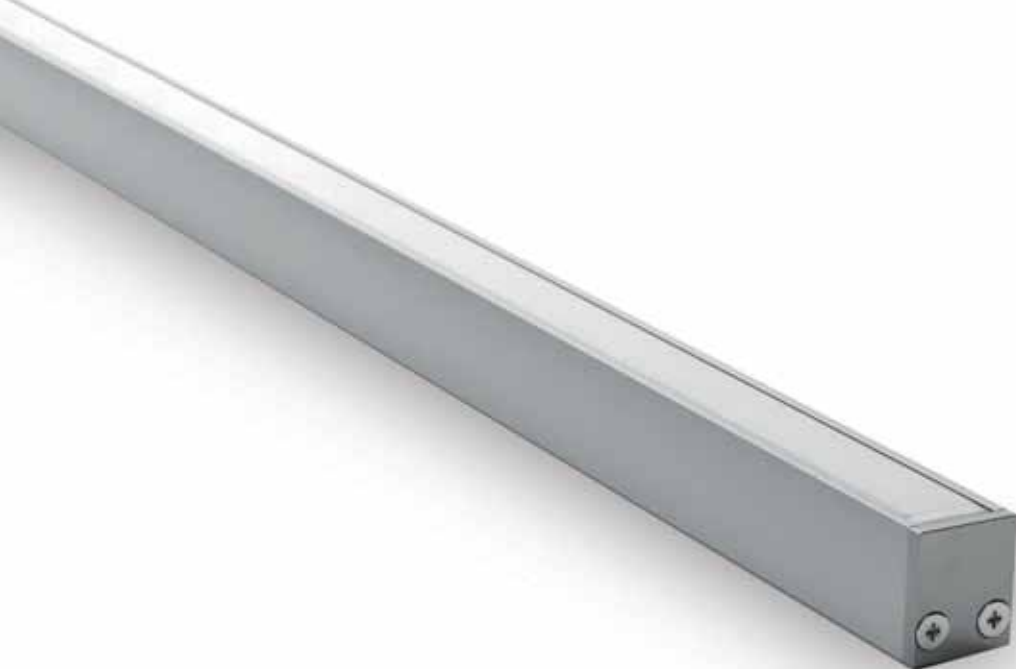

# PELLEY GIO' 10

## PROFILE / PROFILO

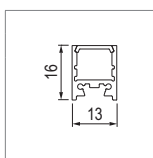

DESCRIPTION / DESCRIZIONE	PART NUMBER / CODICE	FINISH / FINITURA		
		*W	*G	*N
<b>Pelly Gio' 10 profile</b> Profilo Pelly Giò 10	<b>PASA1*AV0</b>			

## STRIPS CHARACTERISTICS / CARATTERISTICHE STRIP

PROFILE / PROFILO	STRIP WIDTH / LARGHEZZA STRIP	MAX DISSIPATION / MASSIMA DISSIPAZIONE
<b>Pelly Gio' 10</b>	<b>8 mm</b>	<b>11 W/mt</b>

## STRIPS COMPATIBILITY / STRIP COMPATIBILI



DESCRIPTION / DESCRIZIONE	POWER / POTENZA	COLOUR / COLORE	PAGE / PAGINA
<b>Young 140 LP / 24 Vdc / 48 Vdc</b>	<b>7 W/m</b>	<b>2200-5700K</b>	<b>298-300</b>

All strips are IP00.  
Tutte le strip sono IP00.



## INSTALLATION / INSTALLAZIONE

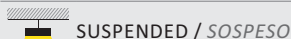

SUSPENDED / *SOSPESO*

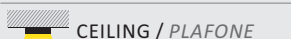

CEILING / *PLAFONE*

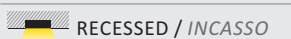

RECESSED / *INCASSO*



WALL / *PARETE*

## CABLE OUTLET / USCITA CAVO



## RESINABLE / RESINABILE



**Pelly Giò 15 is an anodized aluminium and opal flexible polycarbonate profile (20x23 mm).**

Pelly Giò 15 is obtained by combining the Pelly 15 profile with the extruded total white Giò 15 (page 268): the Pelly 15 profile acts as an outer casing of the total white Giò 15 for easy and fast maintenance.

Pelly Giò 15 is also available in IP65 for use in damp and outdoor environments.

*Pelly Giò 15 è un profilo in alluminio anodizzato e policarbonato opale flessibile (20x23 mm). Pelly Giò 15 si ottiene combinando il profilo Pelly 15 con l'estruso total white Giò 15 (pag. 268): il profilo Pelly 15 funge da controscassa del total white Giò 15 per una manutenzione facile e veloce. Pelly Giò 15 è disponibile anche in IP65 per l'utilizzo in ambienti umidi ed esterni.*

## ACCESSORIES / ACCESSORI



Rear profile.  
*Profilo posteriore.*  
**EAQ26000V0T**

W  G  N

F (with hole) SF (no hole)



End cap kit.  
*Kit testate di chiusura.*

**ST1503 = F + SF**  
**ST1504 = F + F**

W  G  N

F (with hole) SF (no hole)



IP65 end cap kit.  
*Kit testate di chiusura IP65.*

**ST1700 = F + SF**  
**ST1701 = F + F**

W  G  N



Mounting clip kit.  
*Kit graffetta di montaggio.*

**ST1611K**



Magnet + plate kit.  
*Kit magnete + lamina.*

**ST1610K**



Magnet kit for metallic structures.  
*Kit magnete per strutture metalliche.*

**CANEQ2V0**



Rear joining plate kit.  
*Kit lamina giunzione posteriore.*

**ST1616K**



Vertical 90° joining rear bracket.  
*Staffa unione barre verticale 90°.*

**ST1625K**



L shaped side fixing bracket.  
*Staffa a L per fissaggio laterale.*

**ST1626K**



90° joining rear bracket kit.  
*Kit staffa unione barre 90°.*

**ST1810K**

W  G  N



Low adjustable bracket kit.  
*Kit staffe orientabili basse.*

**ST1607K**

W  G  N



Medium adjustable bracket kit.  
*Kit staffe orientabili medie.*

**ST1608K**

W  G  N



High adjustable bracket kit.  
*Kit staffe orientabili alte.*

**ST1609K**

W  G  N



Standard profile suspension kit.  
*Kit sospensione profili standard.*

**ST9010K - 3 m**

**ST9012K - 5 m**



Medium profile suspension kit.  
*Kit sospensione profili intermedio.*

**ST9011K - 3 m**

**ST9013K - 5 m**



Kit of two safety cords.  
*Kit due cordini di sicurezza.*

**ST0038K**



# PELLEY GIO' 15

## PROFILE / PROFILO

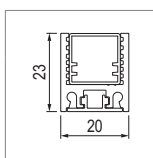

DESCRIPTION / DESCRIZIONE	PART NUMBER / CODICE	FINISH / FINITURA		
		*W	*G	*N
<b>Pelly Gio' 15 profile</b> <i>Profilo Pelly Gio' 15</i>	<b>PASB2*BVO</b>			

## STRIPS CHARACTERISTICS / CARATTERISTICHE STRIP

PROFILE / PROFILO	STRIP WIDTH / LARGHEZZA STRIP	MAX DISSIPATION / MASSIMA DISSIPAZIONE
<b>Pelly Gio' 15</b>	13 mm	12 W/mt

## STRIPS COMPATIBILITY / STRIP COMPATIBILI



DESCRIPTION / DESCRIZIONE	POWER / POTENZA	COLOUR / COLORE	PAGE / PAGINA
<b>Young 140 MP / 24 Vdc / 48 Vdc</b>	12 W/m	2200-5700K	300-301

All strips are IP00.  
Tutte le strip sono IP00.



## INSTALLATION / INSTALLAZIONE



SUSPENDED / *SOSPESO*

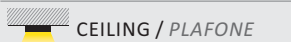

CEILING / *PLAFONE*

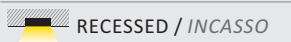

RECESSED / *INCASSO*



WALL / *PARETE*

## CABLE OUTLET / USCITA CAVO



## RESINABLE / RESINABILE



**Pelly Giò 25 is an anodized aluminium and opal flexible polycarbonate profile (30x33 mm).**

Pelly Giò 25 is obtained by combining the Pelly 25 profile with the extruded total white Giò 25 (page 270): the Pelly 25 profile acts as an outer casing of the total white Giò 25 for easy and fast maintenance.

Pelly Giò 25 is also available in IP65 for use in damp and outdoor environments.

*Pelly Giò 25 è un profilo in alluminio anodizzato e policarbonato opale flessibile (30x33 mm). Pelly Giò 25 si ottiene combinando il profilo Pelly 25 con l'estruso total white Giò 25 (pag. 270): il profilo Pelly 25 funge da controscassa del total white Giò 25 per una manutenzione facile e veloce. Pelly Giò 25 è disponibile anche in IP65 per l'utilizzo in ambienti umidi ed esterni.*

## ACCESSORIES / ACCESSORI



**Rear profile.**  
*Profilo posteriore.*  
**EAQ36000V0T**

W  G  N

F (with hole) SF (no hole)



**End cap kit.**  
*Kit testate di chiusura.*  
**ST1506 = F + SF**  
**ST1507 = F + F**

W  G  N

F (with hole) SF (no hole)



**IP65 end cap kit.**  
*Kit testate di chiusura IP65.*  
**ST1900 = F + SF**  
**ST1901 = F + F**

W  G  N



**Mounting clip kit.**  
*Kit graffetta di montaggio.*

**ST1611K**



**Magnet + plate kit.**  
*Kit magnete + lamina.*

**ST1805K**



**Magnet kit for metallic structures.**  
*Kit magnete per strutture metalliche.*

**CANEQ2V0**



**Rear joining plate kit.**  
*Kit lamina giunzione posteriore.*

**ST1616K**



**Vertical 90° joining rear bracket kit.**  
*Staffa unione barre verticale 90°.*

**ST1825K**



**90° joining rear bracket kit.**  
*Kit staffa unione barre 90°.*

**ST1826K**



**L shaped fixing bracket.**  
*Staffa a L per fissaggio laterale.*

**ST1809K**

W  G  N



**Low adjustable bracket kit.**  
*Kit staffe orientabili basse.*

**ST1801K**

W  G  N



**Medium adjustable bracket kit.**  
*Kit staffe orientabili medie.*

**ST1802K**

W  G  N



**High adjustable bracket kit.**  
*Kit staffe orientabili alte.*

**ST1803K**

W  G  N



**Standard profile suspension kit.**  
*Kit sospensione profili standard.*

**ST9010K - 3 m**

**ST9012K - 5 m**



**Medium profile suspension kit.**  
*Kit sospensione profili intermedio.*

**ST9011K - 3 m**

**ST9013K - 5 m**



**Kit of two safety cords.**  
*Kit due cordini di sicurezza.*

**ST0038K**



# PELLEY GIO' 25

## PROFILE / PROFILO

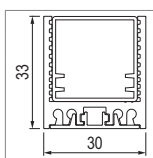

DESCRIPTION / DESCRIZIONE	PART NUMBER / CODICE	FINISH / FINITURA		
		*W	*G	*N
<b>Pelly Gio' 25 profile</b> Profilo Pelly Gio' 25	<b>PASC3*CV0</b>			

## STRIPS CHARACTERISTICS / CARATTERISTICHE STRIP

PROFILE / PROFILO	STRIP WIDTH / LARGHEZZA STRIP	MAX DISSIPATION / MASSIMA DISSIPAZIONE
<b>Pelly Gio' 25</b>	23 mm	15 W/mt

## STRIPS COMPATIBILITY / STRIP COMPATIBILI



DESCRIPTION / DESCRIZIONE	POWER / POTENZA	COLOUR / COLORE	PAGE / PAGINA
<b>Young 140 HP / 24 Vdc / 48 Vdc</b>	15 W/m	2200-5700K	302-303

All strips are IP00.  
Tutte le strip sono IP00.

# HIGH TECHNOLOGY STRIPS

<b>LONG STRETCH</b>	p. 280
<b>TRUE COLOR</b>	p. 284
<b>UNIFORMITY</b>	p. 290
<b>EVOLUTION</b>	p. 292
<b>MICRODECOR</b>	p. 296
<b>YOUNG</b>	p. 298
<b>FULL COLOR</b>	p. 304
<b>SIDE EMITTING</b>	p. 306
<b>KING</b>	p. 308
<b>IRON 6</b>	p. 312







# LONG STRETCH

## QUEEN 168 LP / 48 Vdc



CODE CODICE	IP	POWER POTENZA	FLUX FLUSSO	VOLTAGE VOLTAGGIO	LEDs/m	COLOUR COLORE	CRI	MAX LENGTH** MAX LUNGHEZZA**	E.E. CLASS
MESTF2X8P4OC0	IP 00	7 W/m	860 Lm/m	48 Vdc	168	2200K	80	20 m	A+
MESTF2X8P4AC0	IP 00	7 W/m	1000 Lm/m	48 Vdc	168	2700K	80	20 m	A+
MESTF2X8P4BC0	IP 00	7 W/m	1020 Lm/m	48 Vdc	168	3000K	80	20 m	A+
MESTF2X8P4YC0	IP 00	7 W/m	1020 Lm/m	48 Vdc	168	3500K	80	20 m	A+
MESTF2X8P4CC0	IP 00	7 W/m	1050 Lm/m	48 Vdc	168	4000K	80	20 m	A+
MESTF2X8P4WC0	IP 00	7 W/m	1070 Lm/m	48 Vdc	168	5700K	80	20 m	A+

Dimmable using dedicated controls.

\*\* Maximum strip length with same power cable.

REEL 5 m  
Queen 168 LP / 48 Vdc

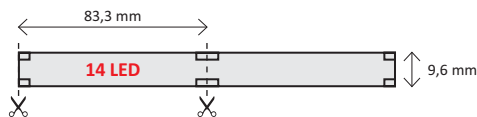

## QUEEN 168 LP / 48 Vdc WATERPROOF — IP 65



CODE CODICE	IP	POWER POTENZA	FLUX FLUSSO	VOLTAGE VOLTAGGIO	LEDs/m	COLOUR COLORE	CRI	MAX LENGTH** MAX LUNGHEZZA**	E.E. CLASS
MESTW3X8P4OC0	IP 65	7 W/m	860 Lm/m	48 Vdc	168	2200K	80	20 m	A+
MESTW3X8P4AC0	IP 65	7 W/m	1000 Lm/m	48 Vdc	168	2700K	80	20 m	A+
MESTW3X8P4BC0	IP 65	7 W/m	1020 Lm/m	48 Vdc	168	3000K	80	20 m	A+
MESTW3X8P4YC0	IP 65	7 W/m	1020 Lm/m	48 Vdc	168	3500K	80	20 m	A+
MESTW3X8P4CC0	IP 65	7 W/m	1050 Lm/m	48 Vdc	168	4000K	80	20 m	A+
MESTW3X8P4WC0	IP 65	7 W/m	1070 Lm/m	48 Vdc	168	5700K	80	20 m	A+

Dimmable using dedicated controls.

\*\* Maximum strip length with same power cable.

REEL 5 m  
Queen 168 LP / 48 Vdc IP65

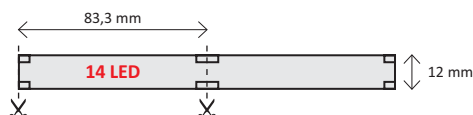

**Professional strip with 48 Vdc power supply which allowing long stretches with just one power cable** (up to 20 m).

The 5 m long Queen reels and can be split every 10 cm and mount LEDs with IRC 80. The power cable sections are considerably smaller than the cables commonly used with low voltage strips.

*Strip professionale alimentata a 48 Vdc che permette lunghi tratti con un unico punto di alimentazione (fino a 20 m).*

*Le bobine della collezione Queen sono lunghe 5 m e sezionabili ogni 10 cm e montano LED con CRI 80. Le sezioni dei cavi di alimentazione sono sensibilmente più piccole rispetto ai cavi usati comunemente con strip di minor voltaggio.*



## QUEEN 168 MP / 48 Vdc



CODE CODICE	IP	POWER POTENZA	FLUX FLUSSO	VOLTAGE VOLTAGGIO	LEDs/m	COLOUR COLORE	CRI	MAX LENGTH** MAX LUNGHEZZA**	E.E. CLASS
MESTF2X2P4OC0	IP 00	12 W/m	1370 Lm/m	48 Vdc	168	2200K	80	15 m	A
MESTF2X2P4AC0	IP 00	12 W/m	1600 Lm/m	48 Vdc	168	2700K	80	15 m	A
MESTF2X2P4BC0	IP 00	12 W/m	1620 Lm/m	48 Vdc	168	3000K	80	15 m	A
MESTF2X2P4YC0	IP 00	12 W/m	1620 Lm/m	48 Vdc	168	3500K	80	15 m	A
MESTF2X2P4CC0	IP 00	12 W/m	1650 Lm/m	48 Vdc	168	4000K	80	15 m	A
MESTF2X2P4WC0	IP 00	12 W/m	1670 Lm/m	48 Vdc	168	5700K	80	15 m	A

Dimmable using dedicated controls.

\*\* Maximum strip length with same power cable.

REEL 5 m  
Queen 168 MP / 48 Vdc

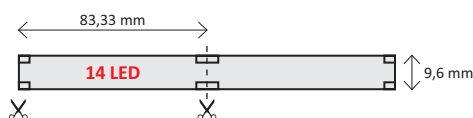

## QUEEN 168 MP / 48 Vdc WATERPROOF — IP 65



CODE CODICE	IP	POWER POTENZA	FLUX FLUSSO	VOLTAGE VOLTAGGIO	LEDs/m	COLOUR COLORE	CRI	MAX LENGTH** MAX LUNGHEZZA**	E.E. CLASS
MESTW3X2P4OC0	IP 65	12 W/m	1370 Lm/m	48 Vdc	168	2200K	80	15 m	A
MESTW3X2P4AC0	IP 65	12 W/m	1600 Lm/m	48 Vdc	168	2700K	80	15 m	A
MESTW3X2P4BC0	IP 65	12 W/m	1620 Lm/m	48 Vdc	168	3000K	80	15 m	A
MESTW3X2P4YC0	IP 65	12 W/m	1620 Lm/m	48 Vdc	168	3500K	80	15 m	A
MESTW3X2P4CC0	IP 65	12 W/m	1650 Lm/m	48 Vdc	168	4000K	80	15 m	A
MESTW3X2P4WC0	IP 65	12 W/m	1670 Lm/m	48 Vdc	168	5700K	80	15 m	A

Dimmable using dedicated controls.

\*\* Maximum strip length with same power cable.

REEL 5 m  
Queen 168 MP / 48 Vdc IP65

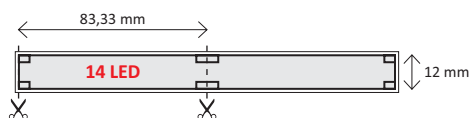



## QUEEN 168 HP / 48 Vdc



CODE CODICE	IP	POWER POTENZA	FLUX FLUSSO	VOLTAGE VOLTAGGIO	LEDs/m	COLOUR COLORE	CRI	MAX LENGTH** MAX LUNGHEZZA**	E.E. CLASS
MESTF3X7P4OC0	IP 00	20 W/m	2070 Lm/m	48 Vdc	168	2200K	80	10 m	A+
MESTF3X7P4AC0	IP 00	20 W/m	2400 Lm/m	48 Vdc	168	2700K	80	10 m	A+
MESTF3X7P4BC0	IP 00	20 W/m	2440 Lm/m	48 Vdc	168	3000K	80	10 m	A++
MESTF3X7P4YC0	IP 00	20 W/m	2440 Lm/m	48 Vdc	168	3500K	80	10 m	A++
MESTF3X7P4CC0	IP 00	20 W/m	2450 Lm/m	48 Vdc	168	4000K	80	10 m	A++
MESTF3X7P4WC0	IP 00	20 W/m	2470 Lm/m	48 Vdc	168	5700K	80	10 m	A++

Dimmable using dedicated controls.

\*\* Maximum strip length with same power cable.

REEL 5 m  
Queen 168 HP / 48 Vdc

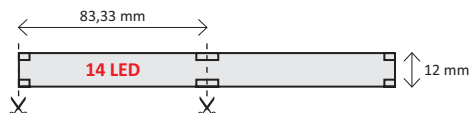

## QUEEN 168 XP / 48 Vdc



CODE CODICE	IP	POWER POTENZA	FLUX FLUSSO	VOLTAGE VOLTAGGIO	LEDs/m	COLOUR COLORE	CRI	MAX LENGTH** MAX LUNGHEZZA**	E.E. CLASS
MESTFGX5Q4OC0	IP 00	25 W/m	2720 Lm/m	48 Vdc	168	2200K	80	8 m	A+
MESTFGX5Q4AC0	IP 00	25 W/m	3150 Lm/m	48 Vdc	168	2700K	80	8 m	A++
MESTFGX5Q4BC0	IP 00	25 W/m	3220 Lm/m	48 Vdc	168	3000K	80	8 m	A++
MESTFGX5Q4YC0	IP 00	25 W/m	3220 Lm/m	48 Vdc	168	3500K	80	8 m	A++
MESTFGX5Q4CC0	IP 00	25 W/m	3240 Lm/m	48 Vdc	168	4000K	80	8 m	A++
MESTFGX5Q4WC0	IP 00	25 W/m	3290 Lm/m	48 Vdc	168	5700K	80	8 m	A++

Dimmable using dedicated controls.

\*\* Maximum strip length with same power cable.

REEL 5 m  
Queen 168 XP / 48 Vdc

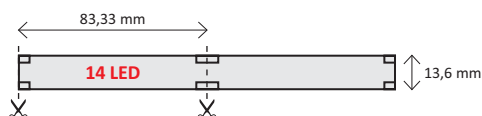

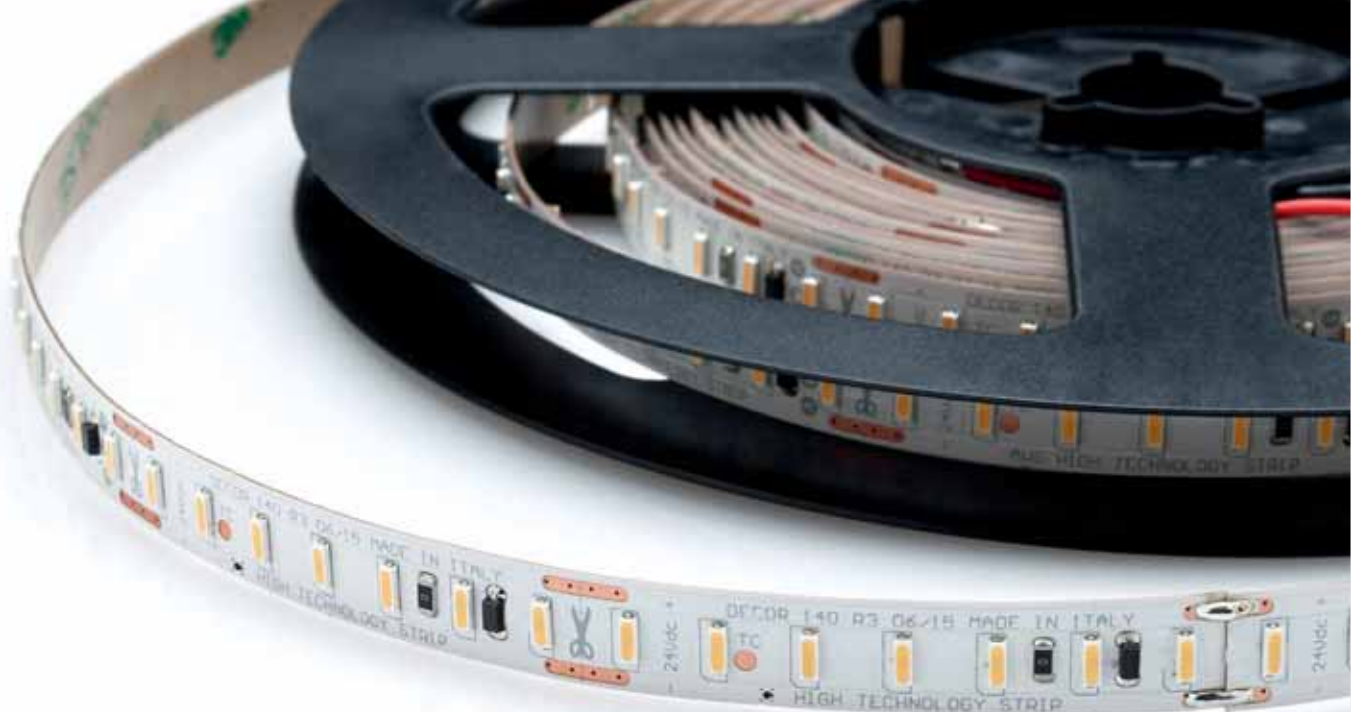

# TRUE COLOR

## DECOR 168 LP / 24 Vdc



CODE CODICE	IP	POWER POTENZA	FLUX FLUSSO	VOLTAGE VOLTAGGIO	LEDs/m	COLOUR COLORE	CRI	MAX LENGTH** MAX LUNGHEZZA**	E.E. CLASS
MESTF2X8P3RB0	IP 00	7 W/m	774 Lm/m	24 Vdc	168	2200K	90	5 m	A+
MESTF2X8P3JB0	IP 00	7 W/m	900 Lm/m	24 Vdc	168	2700K	90	5 m	A+
MESTF2X8P3KB0	IP 00	7 W/m	918 Lm/m	24 Vdc	168	3000K	90	5 m	A+
MESTF2X8P3UB0	IP 00	7 W/m	918 Lm/m	24 Vdc	168	3500K	90	5 m	A+
MESTF2X8P3LB0	IP 00	7 W/m	945 Lm/m	24 Vdc	168	4000K	90	5 m	A+
MESTF2X8P33B0	IP 00	7 W/m	963 Lm/m	24 Vdc	168	5700K	90	5 m	A+

Dimmable using dedicated controls.

\*\* Maximum strip length with same power cable.

REEL 5 m  
Decor 168 LP / 24 Vdc

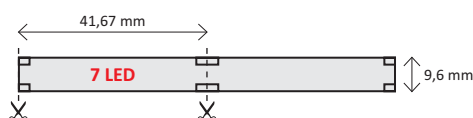

## DECOR 168 LP / 48 Vdc



CODE CODICE	IP	POWER POTENZA	FLUX FLUSSO	VOLTAGE VOLTAGGIO	LEDs/m	COLOUR COLORE	CRI	MAX LENGTH** MAX LUNGHEZZA**	E.E. CLASS
MESTF2X8P4RC0	IP 00	7 W/m	774 Lm/m	48 Vdc	168	2200K	90	20 m	A
MESTF2X8P4JC0	IP 00	7 W/m	900 Lm/m	48 Vdc	168	2700K	90	20 m	A+
MESTF2X8P4KC0	IP 00	7 W/m	918 Lm/m	48 Vdc	168	3000K	90	20 m	A+
MESTF2X8P4UC0	IP 00	7 W/m	918 Lm/m	48 Vdc	168	3500K	90	20 m	A+
MESTF2X8P4LC0	IP 00	7 W/m	945 Lm/m	48 Vdc	168	4000K	90	20 m	A+
MESTF2X8P43C0	IP 00	7 W/m	963 Lm/m	48 Vdc	168	5700K	90	20 m	A+

Dimmable using dedicated controls.

\*\* Maximum strip length with same power cable.

REEL 5 m  
Decor 168 LP / 48 Vdc

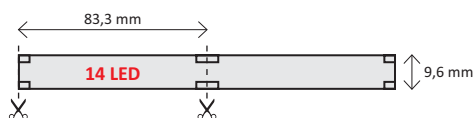

Professional strip with very high colour rendering index LEDs, typical IRC 90. **The Decor collection guarantees high fidelity in highlighting colours, thanks to the next-generation LEDs;** Decor is therefore perfect for retail, museums and all environments where high colour rendering index is an essential condition.

*Strip professionale con LED a elevatissima resa cromatica, CRI tipico 90.*

*La collezione Decor garantisce alta fedeltà nell'evidenziare i colori, grazie ai LED di nuova generazione; Decor è quindi perfetta per il settore retail, nei musei e in tutti gli ambienti in cui l'alta resa cromatica è una condizione fondamentale.*



## DECOR 168 LP / 24 Vdc WATERPROOF — IP 65



CODE CODICE	IP	POWER POTENZA	FLUX FLUSSO	VOLTAGE VOLTAGGIO	LEDs/m	COLOUR COLORE	CRI	MAX LENGTH** MAX LUNGHEZZA**	E.E. CLASS
MESTW3X8P3RBO	IP 65	7 W/m	774 Lm/m	24 Vdc	168	2200K	90	5 m	A+
MESTW3X8P3JBO	IP 65	7 W/m	900 Lm/m	24 Vdc	168	2700K	90	5 m	A+
MESTW3X8P3KBO	IP 65	7 W/m	918 Lm/m	24 Vdc	168	3000K	90	5 m	A+
MESTW3X8P3UBO	IP 65	7 W/m	918 Lm/m	24 Vdc	168	3500K	90	5 m	A+
MESTW3X8P3LBO	IP 65	7 W/m	945 Lm/m	24 Vdc	168	4000K	90	5 m	A+
MESTW3X8P33BO	IP 65	7 W/m	963 Lm/m	24 Vdc	168	5700K	90	5 m	A+

Dimmable using dedicated controls.

\*\* Maximum strip length with same power cable.

REEL 5 m

Decor 168 LP / 24 Vdc IP65

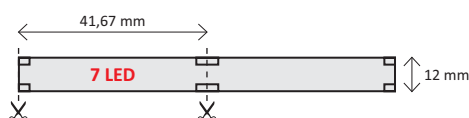

## DECOR 168 LP / 48 Vdc WATERPROOF — IP 65



CODE CODICE	IP	POWER POTENZA	FLUX FLUSSO	VOLTAGE VOLTAGGIO	LEDs/m	COLOUR COLORE	CRI	MAX LENGTH** MAX LUNGHEZZA**	E.E. CLASS
MESTW3X8P4RCO	IP 65	7 W/m	774 Lm/m	48 Vdc	168	2200K	90	20 m	A
MESTW3X8P4JCO	IP 65	7 W/m	900 Lm/m	48 Vdc	168	2700K	90	20 m	A+
MESTW3X8P4KCO	IP 65	7 W/m	918 Lm/m	48 Vdc	168	3000K	90	20 m	A+
MESTW3X8P4UCO	IP 65	7 W/m	918 Lm/m	48 Vdc	168	3500K	90	20 m	A+
MESTW3X8P4LCO	IP 65	7 W/m	945 Lm/m	48 Vdc	168	4000K	90	20 m	A+
MESTW3X8P43CO	IP 65	7 W/m	963 Lm/m	48 Vdc	168	5700K	90	20 m	A+

Dimmable using dedicated controls.

\*\* Maximum strip length with same power cable.

REEL 5 m

Decor 168 LP / 48 Vdc IP65

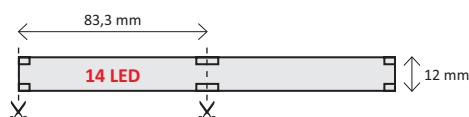

## DECOR 168 MP / 24 Vdc



CODE CODICE	IP	POWER POTENZA	FLUX FLUSSO	VOLTAGE VOLTAGGIO	LEDs/m	COLOUR COLORE	CRI	MAX LENGTH** MAX LUNGHEZZA**	E.E. CLASS
MESTF2X2P3RB0	IP 00	12 W/m	1230 Lm/m	24 Vdc	168	2200K	90	5 m	A
MESTF2X2P3JB0	IP 00	12 W/m	1440 Lm/m	24 Vdc	168	2700K	90	5 m	A
MESTF2X2P3KB0	IP 00	12 W/m	1450 Lm/m	24 Vdc	168	3000K	90	5 m	A
MESTF2X2P3UB0	IP 00	12 W/m	1450 Lm/m	24 Vdc	168	3500K	90	5 m	A
MESTF2X2P3LB0	IP 00	12 W/m	1480 Lm/m	24 Vdc	168	4000K	90	5 m	A
MESTF2X2P33B0	IP 00	12 W/m	1500 Lm/m	24 Vdc	168	5700K	90	5 m	A

Dimmable using dedicated controls.

\*\* Maximum strip length with same power cable.

REEL 5 m  
Decor 168 MP / 24 Vdc

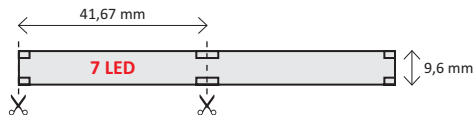

## DECOR 168 MP / 48 Vdc



CODE CODICE	IP	POWER POTENZA	FLUX FLUSSO	VOLTAGE VOLTAGGIO	LEDs/m	COLOUR COLORE	CRI	MAX LENGTH** MAX LUNGHEZZA**	E.E. CLASS
MESTF2X2P4RC0	IP 00	12 W/m	1230 Lm/m	48 Vdc	168	2200K	90	15 m	A
MESTF2X2P4JC0	IP 00	12 W/m	1440 Lm/m	48 Vdc	168	2700K	90	15 m	A
MESTF2X2P4KC0	IP 00	12 W/m	1450 Lm/m	48 Vdc	168	3000K	90	15 m	A
MESTF2X2P4UC0	IP 00	12 W/m	1450 Lm/m	48 Vdc	168	3500K	90	15 m	A
MESTF2X2P4LC0	IP 00	12 W/m	1480 Lm/m	48 Vdc	168	4000K	90	15 m	A
MESTF2X2P43C0	IP 00	12 W/m	1500 Lm/m	48 Vdc	168	5700K	90	15 m	A

Dimmable using dedicated controls.

\*\* Maximum strip length with same power cable.

REEL 5 m  
Decor 168 MP / 48 Vdc

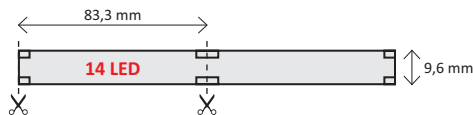

## DECOR 168 MP / 24 Vdc WATERPROOF — IP 65



CODE CODICE	IP	POWER POTENZA	FLUX FLUSSO	VOLTAGE VOLTAGGIO	LEDs/m	COLOUR COLORE	CRI	MAX LENGTH** MAX LUNGHEZZA**	E.E. CLASS
MESTW3X2P3RB0	IP 65	12 W/m	1230 Lm/m	24 Vdc	168	2200K	90	5 m	A
MESTW3X2P3JB0	IP 65	12 W/m	1440 Lm/m	24 Vdc	168	2700K	90	5 m	A
MESTW3X2P3KB0	IP 65	12 W/m	1450 Lm/m	24 Vdc	168	3000K	90	5 m	A
MESTW3X2P3UB0	IP 65	12 W/m	1450 Lm/m	24 Vdc	168	3500K	90	5 m	A
MESTW3X2P3LB0	IP 65	12 W/m	1480 Lm/m	24 Vdc	168	4000K	90	5 m	A
MESTW3X2P33B0	IP 65	12 W/m	1500 Lm/m	24 Vdc	168	5700K	90	5 m	A

Dimmable using dedicated controls.

\*\* Maximum strip length with same power cable.

REEL 5 m  
Decor 168 MP / 24 Vdc IP65

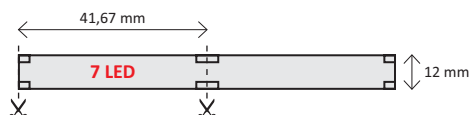



## DECOR 168 MP / 48 Vdc WATERPROOF — IP 65



CODE CODICE	IP	POWER POTENZA	FLUX FLUSSO	VOLTAGE VOLTAGGIO	LEDs/m	COLOUR COLORE	CRI	MAX LENGTH** MAX LUNGHEZZA**	E.E. CLASS
MESTW3X2P4RC0	IP 65	12 W/m	1230 Lm/m	48 Vdc	168	2200K	90	15 m	A
MESTW3X2P4JC0	IP 65	12 W/m	1440 Lm/m	48 Vdc	168	2700K	90	15 m	A
MESTW3X2P4KC0	IP 65	12 W/m	1450 Lm/m	48 Vdc	168	3000K	90	15 m	A
MESTW3X2P4UC0	IP 65	12 W/m	1450 Lm/m	48 Vdc	168	3500K	90	15 m	A
MESTW3X2P4LC0	IP 65	12 W/m	1480 Lm/m	48 Vdc	168	4000K	90	15 m	A
MESTW3X2P43C0	IP 65	12 W/m	1500 Lm/m	48 Vdc	168	5700K	90	15 m	A

Dimmable using dedicated controls.

\*\* Maximum strip length with same power cable.

REEL 5 m  
Decor 168 MP / 48 Vdc IP65

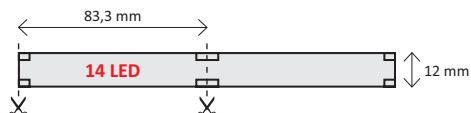

## DECOR 168 HP / 24 Vdc



CODE CODICE	IP	POWER POTENZA	FLUX FLUSSO	VOLTAGE VOLTAGGIO	LEDs/m	COLOUR COLORE	CRI	MAX LENGTH** MAX LUNGHEZZA**	E.E. CLASS
MESTF3X7P3RB0	IP 00	20 W/m	1860 Lm/m	24 Vdc	168	2200K	90	5 m	A
MESTF3X7P3JB0	IP 00	20 W/m	2160 Lm/m	24 Vdc	168	2700K	90	5 m	A+
MESTF3X7P3KB0	IP 00	20 W/m	2190 Lm/m	24 Vdc	168	3000K	90	5 m	A+
MESTF3X7P3UB0	IP 00	20 W/m	2190 Lm/m	24 Vdc	168	3500K	90	5 m	A+
MESTF3X7P3LB0	IP 00	20 W/m	2200 Lm/m	24 Vdc	168	4000K	90	5 m	A+
MESTF3X7P33B0	IP 00	20 W/m	2220 Lm/m	24 Vdc	168	5700K	90	5 m	A+

Dimmable using dedicated controls.

\*\* Maximum strip length with same power cable.

REEL 5 m  
Decor 168 HP / 24 Vdc

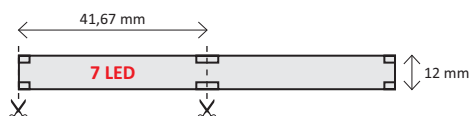

## DECOR 168 HP / 48 Vdc



CODE CODICE	IP	POWER POTENZA	FLUX FLUSSO	VOLTAGE VOLTAGGIO	LEDs/m	COLOUR COLORE	CRI	MAX LENGTH** MAX LUNGHEZZA**	E.E. CLASS
MESTF3X7P4RC0	IP 00	20 W/m	1860 Lm/m	48 Vdc	168	2200K	90	10 m	A
MESTF3X7P4JC0	IP 00	20 W/m	2160 Lm/m	48 Vdc	168	2700K	90	10 m	A+
MESTF3X7P4KC0	IP 00	20 W/m	2190 Lm/m	48 Vdc	168	3000K	90	10 m	A+
MESTF3X7P4UC0	IP 00	20 W/m	2190 Lm/m	48 Vdc	168	3500K	90	10 m	A+
MESTF3X7P4LC0	IP 00	20 W/m	2200 Lm/m	48 Vdc	168	4000K	90	10 m	A+
MESTF3X7P43C0	IP 00	20 W/m	2220 Lm/m	48 Vdc	168	5700K	90	10 m	A+

Dimmable using dedicated controls.

\*\* Maximum strip length with same power cable.

REEL 5 m  
Decor 168 HP / 48 Vdc

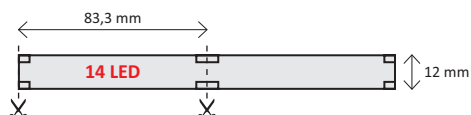

## DECOR 168 XP / 24 Vdc



CODE CODICE	IP	POWER POTENZA	FLUX FLUSSO	VOLTAGE VOLTAGGIO	LEDs/m	COLOUR COLORE	CRI	MAX LENGTH** MAX LUNGHEZZA**	E.E. CLASS
MESTFGX5Q3RB0	IP 00	25 W/m	2448 Lm/m	24 Vdc	168	2200K	90	5 m	A
MESTFGX5Q3JB0	IP 00	25 W/m	2835 Lm/m	24 Vdc	168	2700K	90	5 m	A+
MESTFGX5Q3KB0	IP 00	25 W/m	2898 Lm/m	24 Vdc	168	3000K	90	5 m	A+
MESTFGX5Q3UB0	IP 00	25 W/m	2898 Lm/m	24 Vdc	168	3500K	90	5 m	A+
MESTFGX5Q3LB0	IP 00	25 W/m	2916 Lm/m	24 Vdc	168	4000K	90	5 m	A+
MESTFGX5Q33B0	IP 00	25 W/m	2916 Lm/m	24 Vdc	168	5700K	90	5 m	A+

Dimmable using dedicated controls.

\*\* Maximum strip length with same power cable.

REEL 5 m  
Decor 168 XP / 24 Vdc

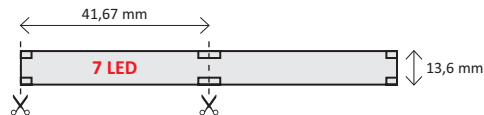

## DECOR 168 XP / 48 Vdc



CODE CODICE	IP	POWER POTENZA	FLUX FLUSSO	VOLTAGE VOLTAGGIO	LEDs/m	COLOUR COLORE	CRI	MAX LENGTH** MAX LUNGHEZZA**	E.E. CLASS
MESTFGX5Q4RC0	IP 00	25 W/m	2448 Lm/m	48 Vdc	168	2200K	90	8 m	A
MESTFGX5Q4JC0	IP 00	25 W/m	2835 Lm/m	48 Vdc	168	2700K	90	8 m	A+
MESTFGX5Q4KC0	IP 00	25 W/m	2898 Lm/m	48 Vdc	168	3000K	90	8 m	A+
MESTFGX5Q4UC0	IP 00	25 W/m	2898 Lm/m	48 Vdc	168	3500K	90	8 m	A+
MESTFGX5Q4LC0	IP 00	25 W/m	2916 Lm/m	48 Vdc	168	4000K	90	8 m	A+
MESTFGX5Q43C0	IP 00	25 W/m	2961 Lm/m	48 Vdc	168	5700K	90	8 m	A+

Dimmable using dedicated controls.

\*\* Maximum strip length with same power cable.

REEL 5 m  
Decor 168 XP / 48 Vdc

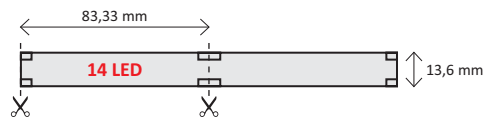

## DECOR 216 MP / 24 Vdc



CODE CODICE	IP	POWER POTENZA	FLUX FLUSSO	VOLTAGE VOLTAGGIO	LEDs/m	COLOUR COLORE	CRI	MAX LENGTH** MAX LUNGHEZZA**	E.E. CLASS
MESTF2FDPLRB0	IP 00	15 W/m	1467 Lm/m	24 Vdc	216	2200K	90	5 m	A
MESTF2FDPLJB0	IP 00	15 W/m	1710 Lm/m	24 Vdc	216	2700K	90	5 m	A
MESTF2FDPLKB0	IP 00	15 W/m	1728 Lm/m	24 Vdc	216	3000K	90	5 m	A
MESTF2FDPLUB0	IP 00	15 W/m	1728 Lm/m	24 Vdc	216	3500K	90	5 m	A
MESTF2FDPLLBO	IP 00	15 W/m	1764 Lm/m	24 Vdc	216	4000K	90	5 m	A
MESTF2FDPL3B0	IP 00	15 W/m	1809 Lm/m	24 Vdc	216	5700K	90	5 m	A

Dimmable using dedicated controls.

\*\* Maximum strip length with same power cable.

**REEL 5 m**  
Decor 216 MP / 24 Vdc

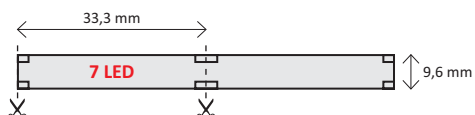



# UNIFORMITY

## EVO 216 MP / 24 Vdc



CODE CODICE	IP	POWER POTENZA	FLUX FLUSSO	VOLTAGE VOLTAGGIO	LEDs/m	COLOUR COLORE	CRI	MAX LENGTH** MAX LUNGHEZZA**	E.E. CLASS
MESTF2FDPL0B0	IP 00	15 W/m	1630 Lm/m	24 Vdc	216	2200K	80	5 m	A
MESTF2FDPLAB0	IP 00	15 W/m	1900 Lm/m	24 Vdc	216	2700K	80	5 m	A
MESTF2FDPLBB0	IP 00	15 W/m	1920 Lm/m	24 Vdc	216	3000K	80	5 m	A
MESTF2FDPLYB0	IP 00	15 W/m	1920 Lm/m	24 Vdc	216	3500K	80	5 m	A
MESTF2FDPLCB0	IP 00	15 W/m	1960 Lm/m	24 Vdc	216	4000K	80	5 m	A
MESTF2FDPLWB0	IP 00	15 W/m	2010 Lm/m	24 Vdc	216	5700K	80	5 m	A

Dimmable using dedicated controls.

\*\* Maximum strip length with same power cable.

REEL 5 m  
Evo 216 MP / 24 Vdc

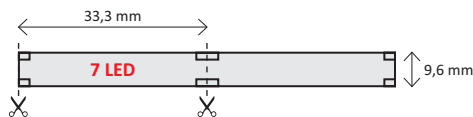

## UNIFORM 288 / 24 Vdc



CODE CODICE	IP	POWER POTENZA	FLUX FLUSSO	VOLTAGE VOLTAGGIO	LEDs/m	COLOUR COLORE	CRI	MAX LENGTH** MAX LUNGHEZZA**	E.E. CLASS
MESTF3G4C50B0	IP 00	19 W/m	1722 Lm/m	24 Vdc	288	2200K	80	5 m	A+
MESTF3G4C5PB0	IP 00	19 W/m	1914 Lm/m	24 Vdc	288	2500K	80	5 m	A+
MESTF3G4C5AB0	IP 00	19 W/m	2150 Lm/m	24 Vdc	288	2700K	80	5 m	A+
MESTF3G4C5BB0	IP 00	19 W/m	2150 Lm/m	24 Vdc	288	3000K	80	5 m	A+
MESTF3G4C5CB0	IP 00	19 W/m	2215 Lm/m	24 Vdc	288	4000K	80	5 m	A++
MESTF3G4C5WB0	IP 00	19 W/m	2259 Lm/m	24 Vdc	288	5700K	80	5 m	A++

Dimmable using dedicated controls.

\*\* Maximum strip length with same power cable.

REEL 5 m  
Uniform 288 / 24 Vdc

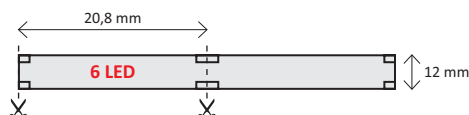

**The main feature of Uniform collection is the high concentration of LEDs/m,** which generates very homogeneous light lines. Uniform is the optimal solution for fluorescence replacement. Effective as direct, indirect and primary source.

*La collezione Uniform è caratterizzata dall'alta concentrazione di LED/m, che crea linee di luce molto omogenee. Uniform è la soluzione ottimale in sostituzione alle fluorescenze. Efficace come sorgente diretta, indiretta e primaria.*

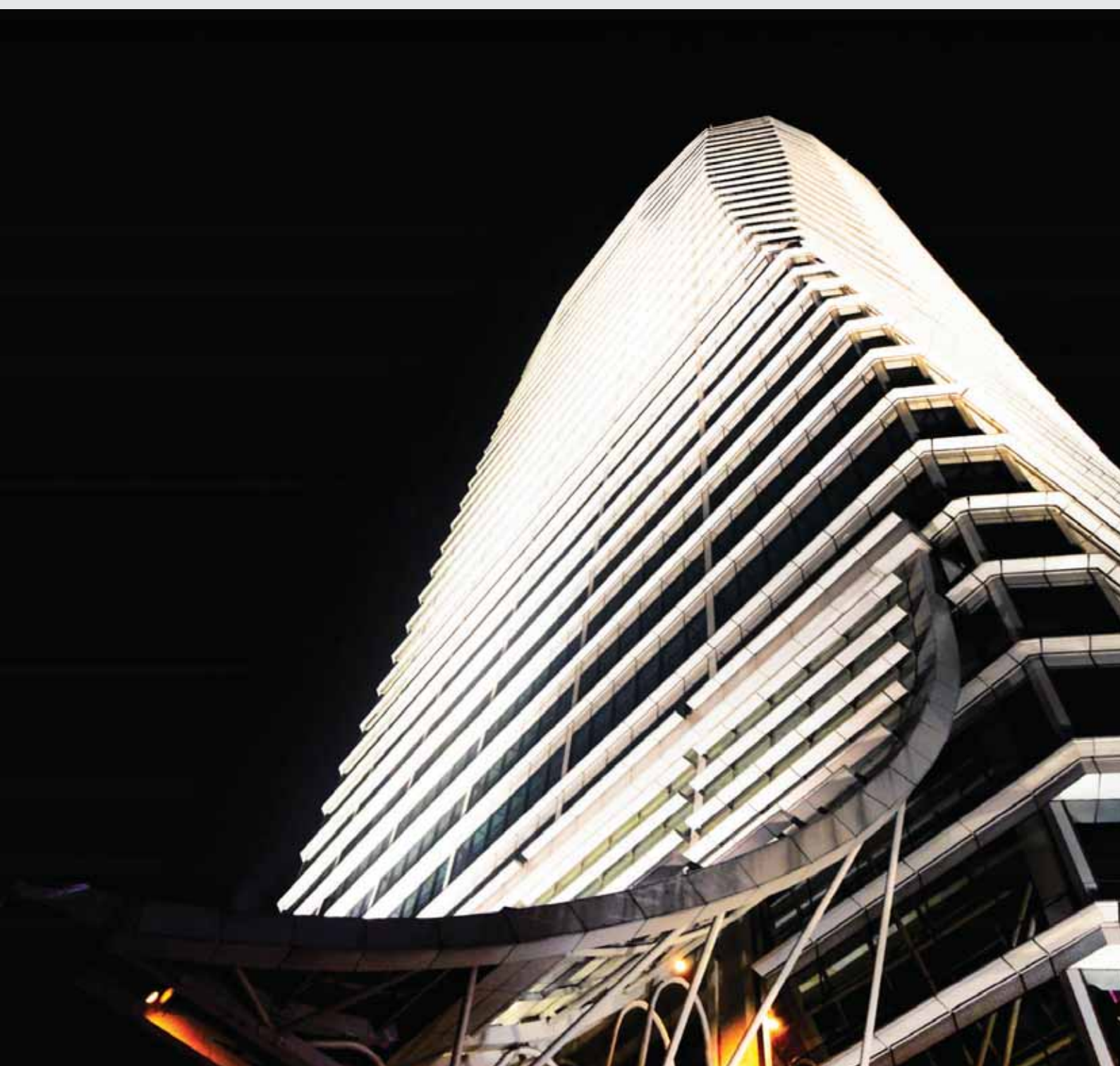



# EVOLUTION

## EVO 168 LP / 24 Vdc



CODE CODICE	IP	POWER POTENZA	FLUX FLUSSO	VOLTAGE VOLTAGGIO	LEDs/m	COLOUR COLORE	CRI	MAX LENGTH** MAX LUNGHEZZA**	E.E. CLASS
MESTF2X8P3OB0	IP 00	7 W/m	860 Lm/m	24 Vdc	168	2200K	80	5 m	A+
MESTF2X8P3AB0	IP 00	7 W/m	1000 Lm/m	24 Vdc	168	2700K	80	5 m	A+
MESTF2X8P3BB0	IP 00	7 W/m	1020 Lm/m	24 Vdc	168	3000K	80	5 m	A+
MESTF2X8P3YB0	IP 00	7 W/m	1020 Lm/m	24 Vdc	168	3500K	80	5 m	A+
MESTF2X8P3CB0	IP 00	7 W/m	1050 Lm/m	24 Vdc	168	4000K	80	5 m	A+
MESTF2X8P3WB0	IP 00	7 W/m	1070 Lm/m	24 Vdc	168	5700K	80	5 m	A+

Dimmable using dedicated controls.

\*\* Maximum strip length with same power cable.

REEL 5 m  
Evo 168 LP / 24 Vdc

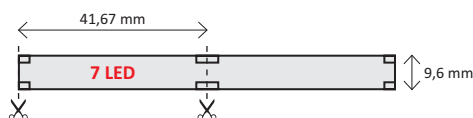

## EVO 168 LP / 24 Vdc WATERPROOF — IP 65



CODE CODICE	IP	POWER POTENZA	FLUX FLUSSO	VOLTAGE VOLTAGGIO	LEDs/m	COLOUR COLORE	CRI	MAX LENGTH** MAX LUNGHEZZA**	E.E. CLASS
MESTW3X8P3OB0	IP 65	7 W/m	860 Lm/m	24 Vdc	168	2200K	80	5 m	A+
MESTW3X8P3AB0	IP 65	7 W/m	1000 Lm/m	24 Vdc	168	2700K	80	5 m	A+
MESTW3X8P3BB0	IP 65	7 W/m	1020 Lm/m	24 Vdc	168	3000K	80	5 m	A+
MESTW3X8P3YB0	IP 65	7 W/m	1020 Lm/m	24 Vdc	168	3500K	80	5 m	A+
MESTW3X8P3CB0	IP 65	7 W/m	1050 Lm/m	24 Vdc	168	4000K	80	5 m	A+
MESTW3X8P3WB0	IP 65	7 W/m	1070 Lm/m	24 Vdc	168	5700K	80	5 m	A+

Dimmable using dedicated controls.

\*\* Maximum strip length with same power cable.

REEL 5 m  
Evo 168 LP / 24 Vdc IP65

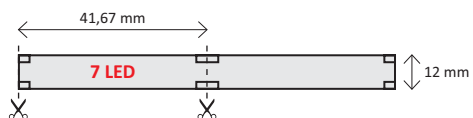

Highly professional strip series designed to satisfy the more demanding needs;

**Evolution series is the right solution for fluorescence replacement,**

**both in terms of uniformity for light emissions and performance.**

Effective as direct, indirect and primary source. Evolution series is dimmable using the controls and standard power supplies listed in the specific sections.

To be installed on heat sink supports suitable for power rating and able to guarantee specified IP protection.

Complete with 3M double-sided tape.

*Strip altamente professionali realizzate per soddisfare le richieste più esigenti; la serie Evolution è la soluzione giusta in sostituzione alle fluorescenze, sia per l'uniformità di emissione che per le prestazioni. Efficace come sorgente diretta, indiretta e primaria.*

*La serie Evolution è dimmerabile attraverso la linea di controlli ed alimentatori a norma lighting proposti nelle sezioni dedicate.*

*Da installare su supporti dissipativi adeguati alla potenza espressa, che garantiscano anche il corretto grado di protezione IP.*

*Completa di biadesivo 3M.*



## EVO 168 MP / 24 Vdc



CODE CODICE	IP	POWER POTENZA	FLUX FLUSSO	VOLTAGE VOLTAGGIO	LEDs/m	COLOUR COLORE	CRI	MAX LENGTH** MAX LUNGHEZZA**	E.E. CLASS
MESTF2X2P3OB0	IP 00	12 W/m	1370 Lm/m	24 Vdc	168	2200K	80	5 m	A+
MESTF2X2P3AB0	IP 00	12 W/m	1600 Lm/m	24 Vdc	168	2700K	80	5 m	A+
MESTF2X2P3BB0	IP 00	12 W/m	1620 Lm/m	24 Vdc	168	3000K	80	5 m	A+
MESTF2X2P3YB0	IP 00	12 W/m	1620 Lm/m	24 Vdc	168	3500K	80	5 m	A+
MESTF2X2P3CB0	IP 00	12 W/m	1650 Lm/m	24 Vdc	168	4000K	80	5 m	A+
MESTF2X2P3WB0	IP 00	12 W/m	1670 Lm/m	24 Vdc	168	5700K	80	5 m	A+

Dimmable using dedicated controls.

\*\* Maximum strip length with same power cable.

REEL 5 m  
Evo 168 MP / 24 Vdc

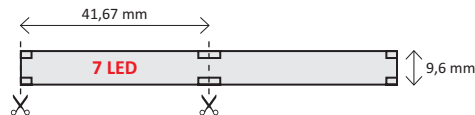

## EVO 168 MP / 24 Vdc WATERPROOF — IP 65



CODE CODICE	IP	POWER POTENZA	FLUX FLUSSO	VOLTAGE VOLTAGGIO	LEDs/m	COLOUR COLORE	CRI	MAX LENGTH** MAX LUNGHEZZA**	E.E. CLASS
MESTW3X2P3OB0	IP 65	12 W/m	1370 Lm/m	24 Vdc	168	2200K	80	5 m	A+
MESTW3X2P3AB0	IP 65	12 W/m	1600 Lm/m	24 Vdc	168	2700K	80	5 m	A+
MESTW3X2P3BB0	IP 65	12 W/m	1620 Lm/m	24 Vdc	168	3000K	80	5 m	A+
MESTW3X2P3YB0	IP 65	12 W/m	1620 Lm/m	24 Vdc	168	3500K	80	5 m	A+
MESTW3X2P3CB0	IP 65	12 W/m	1650 Lm/m	24 Vdc	168	4000K	80	5 m	A+
MESTW3X2P3WB0	IP 65	12 W/m	1670 Lm/m	24 Vdc	168	5700K	80	5 m	A+

Dimmable using dedicated controls.

\*\* Maximum strip length with same power cable.

REEL 5 m  
Evo 168 MP / 24 Vdc IP65

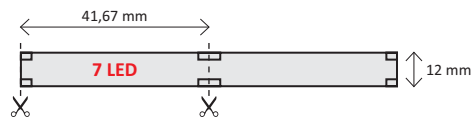

## EVO 168 HP / 24 Vdc



CODE CODICE	IP	POWER POTENZA	FLUX FLUSSO	VOLTAGE VOLTAGGIO	LEDs/m	COLOUR COLORE	CRI	MAX LENGTH** MAX LUNGHEZZA**	E.E. CLASS
MESTF3X7P3OB0	IP 00	20 W/m	2070 Lm/m	24 Vdc	168	2200K	80	5 m	A+
MESTF3X7P3AB0	IP 00	20 W/m	2400 Lm/m	24 Vdc	168	2700K	80	5 m	A+
MESTF3X7P3BB0	IP 00	20 W/m	2440 Lm/m	24 Vdc	168	3000K	80	5 m	A+
MESTF3X7P3YB0	IP 00	20 W/m	2440 Lm/m	24 Vdc	168	3500K	80	5 m	A+
MESTF3X7P3CB0	IP 00	20 W/m	2450 Lm/m	24 Vdc	168	4000K	80	5 m	A+
MESTF3X7P3WB0	IP 00	20 W/m	2470 Lm/m	24 Vdc	168	5700K	80	5 m	A+

Dimmable using dedicated controls.

\*\* Maximum strip length with same power cable.

REEL 5 m  
Evo 168 HP / 24 Vdc

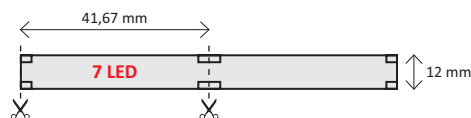



## EVO 168 HP / 24 Vdc — FRESH FOOD



CODE CODICE	IP	POWER POTENZA	FLUX FLUSSO	VOLTAGE VOLTAGGIO	LEDs/m	COLOUR COLORE	CRI	MAX LENGTH** MAX LUNGHEZZA**	E.E. CLASS
<b>MESTF3X7P31B0</b>	IP 00	20 W/m	1450 Lm/m	24 Vdc	168	Carne con grasso	80	5 m	A

Dimmable using dedicated controls.

\*\* Maximum strip length with same power cable.

REEL 5 m  
Evo 168 HP / 24 Vdc

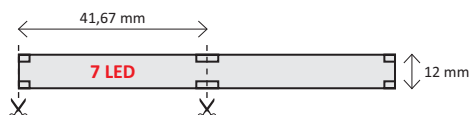

## EVO 168 XP / 24 Vdc



CODE CODICE	IP	POWER POTENZA	FLUX FLUSSO	VOLTAGE VOLTAGGIO	LEDs/m	COLOUR COLORE	CRI	MAX LENGTH** MAX LUNGHEZZA**	E.E. CLASS
<b>MESTFGX5Q3OB0</b>	IP 00	25 W/m	2720 Lm/m	24 Vdc	168	2200K	80	5 m	A+
<b>MESTFGX5Q3AB0</b>	IP 00	25 W/m	3150 Lm/m	24 Vdc	168	2700K	80	5 m	A++
<b>MESTFGX5Q3BB0</b>	IP 00	25 W/m	3220 Lm/m	24 Vdc	168	3000K	80	5 m	A++
<b>MESTFGX5Q3YB0</b>	IP 00	25 W/m	3220 Lm/m	24 Vdc	168	3500K	80	5 m	A++
<b>MESTFGX5Q3CB0</b>	IP 00	25 W/m	3240 Lm/m	24 Vdc	168	4000K	80	5 m	A++
<b>MESTFGX5Q3WB0</b>	IP 00	25 W/m	3290 Lm/m	24 Vdc	168	5700K	80	5 m	A++

Dimmable using dedicated controls.

\*\* Maximum strip length with same power cable.

REEL 5 m  
Evo 168 XP / 24 Vdc

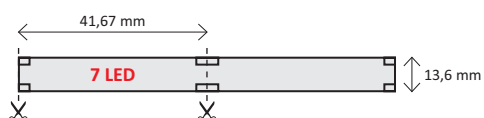



# MICRODECOR

## MICRODECOR 180 / 24 Vdc



CODE CODICE	IP	POWER POTENZA	FLUX FLUSSO	VOLTAGE VOLTAGGIO	LEDs/m	COLOUR COLORE	CRI	MAX LENGTH** MAX LUNGHEZZA**	E.E. CLASS
WA24I30180452	IP 00	9 W/m	520 Lm/m	24 Vdc	180	2200K	90	3 m	A
WA24I30180502	IP 00	9 W/m	842 Lm/m	24 Vdc	180	2700K	90	3 m	A
WA24I30180602	IP 00	9 W/m	842 Lm/m	24 Vdc	180	3000K	90	3 m	A
WA24I30180552	IP 00	9 W/m	845 Lm/m	24 Vdc	180	4000K	90	3 m	A
WA24I30180702	IP 00	9 W/m	950 Lm/m	24 Vdc	180	6000K	90	3 m	A+

Dimmable using dedicated controls.

\*\* Maximum strip length with same power cable.

REEL 3 m  
Microdecor 180 / 24 Vdc

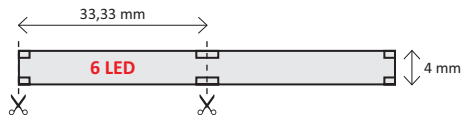

**The Microdecor strip is characterised particularly by its small size: with only 4.5 mm in width it is among the smallest printed circuits on the market.**

It is inserted within the appropriate profiles, allowing thin decorative light lines and effect lighting. It is perfect in display cases and glass showcases or cabinets.

Microdecor has IRC 90.

*La strip Microdecor è caratterizzata da dimensioni particolarmente ridotte: con soli 4,5 mm di larghezza è tra i circuiti stampati più piccoli nel mercato.*

*Inserita all'interno di profili adeguati, permette linee di luce decorative sottili e illuminazione d'effetto. Perfetta in teche, vetrinette o armadiature.*

*Microdecor ha CRI 90.*

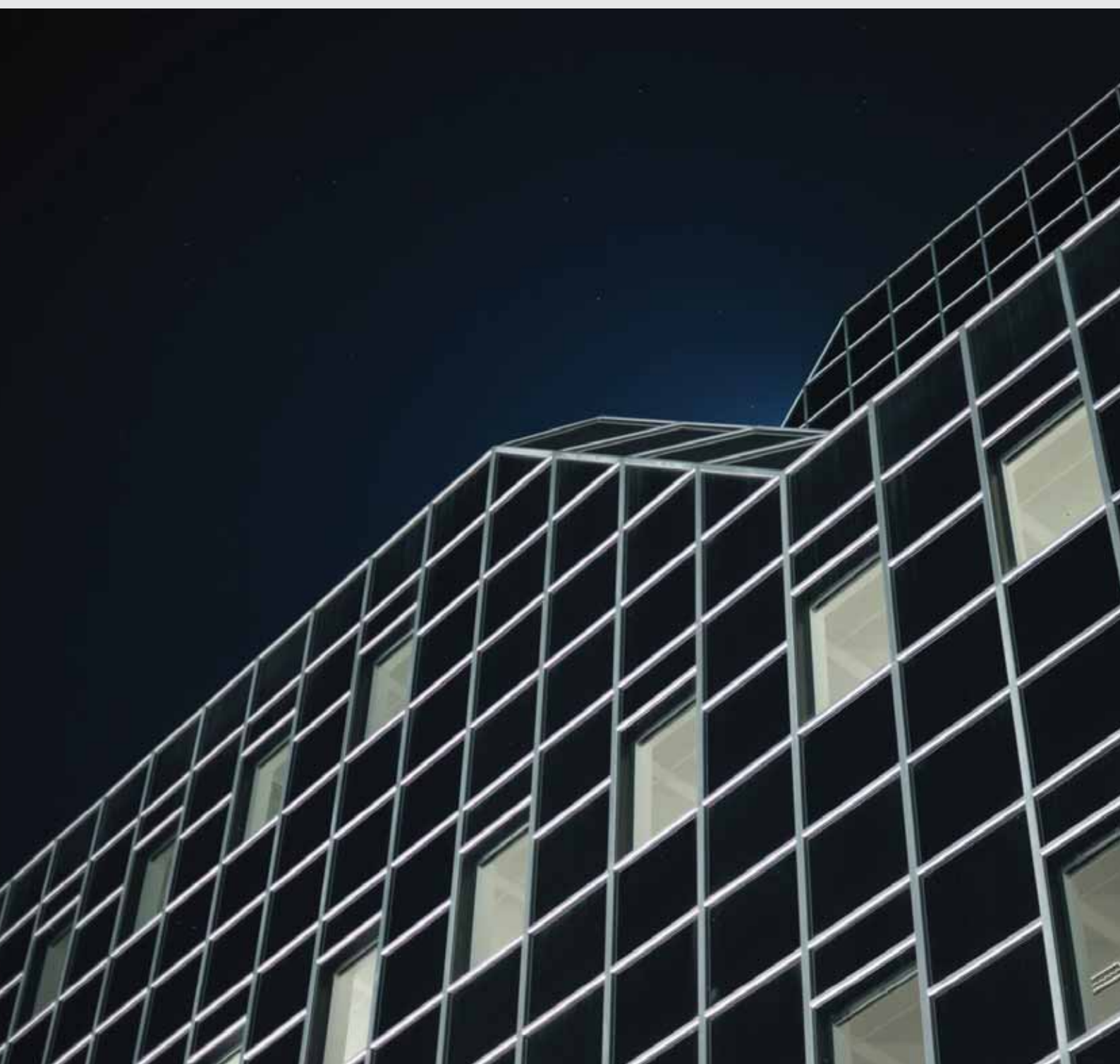



# YOUNG

## YOUNG 140 LP / 24 Vdc — CRI 80



CODE CODICE	IP	POWER POTENZA	FLUX FLUSSO	VOLTAGE VOLTAGGIO	LEDs/m	COLOUR COLORE	CRI	MAX LENGTH** MAX LUNGHEZZA**	E.E. CLASS
MESTBCM8CBOB0	IP 00	7 W/m	785 Lm/m	24 Vdc	140	2200K	80	5 m	A+
MESTBCM8CBP0	IP 00	7 W/m	872 Lm/m	24 Vdc	140	2500K	80	5 m	A+
MESTBCM8CBAB0	IP 00	7 W/m	980 Lm/m	24 Vdc	140	2700K	80	5 m	A++
MESTBCM8CBB0	IP 00	7 W/m	980 Lm/m	24 Vdc	140	3000K	80	5 m	A++
MESTBCM8CBC0	IP 00	7 W/m	1009 Lm/m	24 Vdc	140	4000K	80	5 m	A++
MESTBCM8CBW0	IP 00	7 W/m	1030 Lm/m	24 Vdc	140	5700K	80	5 m	A++

Dimmable using dedicated controls.

\*\* Maximum strip length with same power cable.

MODULE BY 500 mm  
Young 140 LP / 24 Vdc - CRI 80

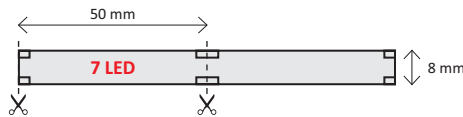

## YOUNG 140 LP / 24 Vdc — CRI 90



CODE CODICE	IP	POWER POTENZA	FLUX FLUSSO	VOLTAGE VOLTAGGIO	LEDs/m	COLOUR COLORE	CRI	MAX LENGTH** MAX LUNGHEZZA**	E.E. CLASS
MESTBCM8CBR0	IP 00	7 W/m	785 Lm/m	24 Vdc	140	2200K	90	5 m	A+
MESTBCM8CBJ0	IP 00	7 W/m	980 Lm/m	24 Vdc	140	2700K	90	5 m	A++
MESTBCM8CBK0	IP 00	7 W/m	980 Lm/m	24 Vdc	140	3000K	90	5 m	A++
MESTBCM8CBL0	IP 00	7 W/m	1009 Lm/m	24 Vdc	140	4000K	90	5 m	A++
MESTBCM8CB30	IP 00	7 W/m	1030 Lm/m	24 Vdc	140	5700K	90	5 m	A++

Dimmable using dedicated controls.

\*\* Maximum strip length with same power cable.

MODULE BY 500 mm  
Young 140 LP / 24 Vdc - CRI 90

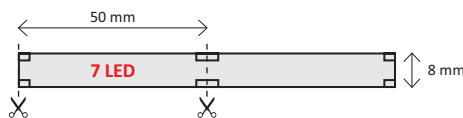

**A semi-rigid circuit with self heating  
dissipating in FR4 with connectors,  
generated for quick insertion into  
profile types Giò or similar.**

*Circuito semirigido autodissipante  
in FR4 con connettori, creato  
per inserimenti rapidi in profili  
tipo Giò o simili.*

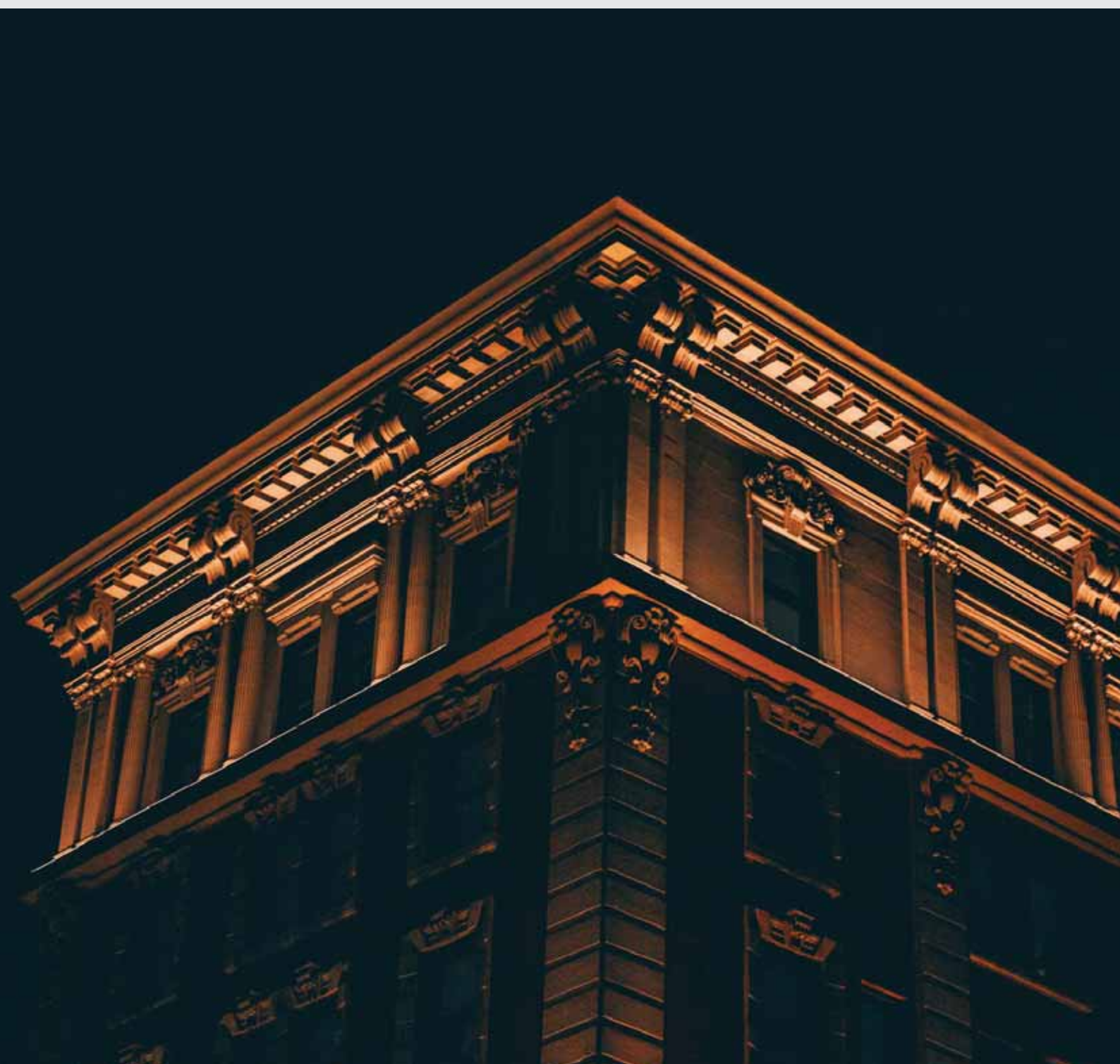

YOUNG 140 LP / 48 Vdc — CRI 80



CODE CODICE	IP	POWER POTENZA	FLUX FLUSSO	VOLTAGE VOLTAGGIO	LEDs/m	COLOUR COLORE	CRI	MAX LENGTH** MAX LUNGHEZZA**	E.E. CLASS
MESTBCM8C6OC0	IP 00	7 W/m	785 Lm/m	48 Vdc	140	2200K	80	10 m	A+
MESTBCM8C6PC0	IP 00	7 W/m	872 Lm/m	48 Vdc	140	2500K	80	10 m	A+
MESTBCM8C6AC0	IP 00	7 W/m	980 Lm/m	48 Vdc	140	2700K	80	10 m	A++
MESTBCM8C6BC0	IP 00	7 W/m	980 Lm/m	48 Vdc	140	3000K	80	10 m	A++
MESTBCM8C6CC0	IP 00	7 W/m	1009 Lm/m	48 Vdc	140	4000K	80	10 m	A++
MESTBCM8C6WC0	IP 00	7 W/m	1030 Lm/m	48 Vdc	140	5700K	80	10 m	A++

Dimmable using dedicated controls.

\*\* Maximum strip length with same power cable.

MODULE BY 500 mm  
Young 140 LP / 48 Vdc - CRI 80

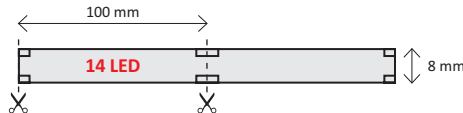

YOUNG 140 LP / 48 Vdc — CRI 90



CODE CODICE	IP	POWER POTENZA	FLUX FLUSSO	VOLTAGE VOLTAGGIO	LEDs/m	COLOUR COLORE	CRI	MAX LENGTH** MAX LUNGHEZZA**	E.E. CLASS
MESTBCM8C6RC0	IP 00	7 W/m	785 Lm/m	48 Vdc	140	2200K	90	10 m	A+
MESTBCM8C6JC0	IP 00	7 W/m	980 Lm/m	48 Vdc	140	2700K	90	10 m	A++
MESTBCM8C6KC0	IP 00	7 W/m	980 Lm/m	48 Vdc	140	3000K	90	10 m	A++
MESTBCM8C6LC0	IP 00	7 W/m	1009 Lm/m	48 Vdc	140	4000K	90	10 m	A++
MESTBCM8C63C0	IP 00	7 W/m	1030 Lm/m	48 Vdc	140	5700K	90	10 m	A++

Dimmable using dedicated controls.

\*\* Maximum strip length with same power cable.

MODULE BY 500 mm  
Young 140 LP / 48 Vdc - CRI 90

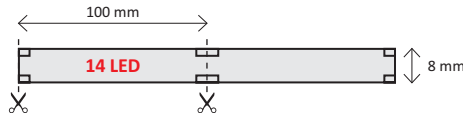

YOUNG 140 MP / 24 Vdc — CRI 80



CODE CODICE	IP	POWER POTENZA	FLUX FLUSSO	VOLTAGE VOLTAGGIO	LEDs/m	COLOUR COLORE	CRI	MAX LENGTH** MAX LUNGHEZZA**	E.E. CLASS
MESTBFM2CBOB0	IP 00	12 W/m	1227 Lm/m	24 Vdc	140	2200K	80	5 m	A+
MESTBFM2CBPB0	IP 00	12 W/m	1363 Lm/m	24 Vdc	140	2500K	80	5 m	A+
MESTBFM2CBAB0	IP 00	12 W/m	1532 Lm/m	24 Vdc	140	2700K	80	5 m	A++
MESTBFM2CBBB0	IP 00	12 W/m	1532 Lm/m	24 Vdc	140	3000K	80	5 m	A++
MESTBFM2CBCB0	IP 00	12 W/m	1578 Lm/m	24 Vdc	140	4000K	80	5 m	A++
MESTBFM2CBWB0	IP 00	12 W/m	1610 Lm/m	24 Vdc	140	5700K	80	5 m	A++

Dimmable using dedicated controls.

\*\* Maximum strip length with same power cable.

MODULE BY 500 mm  
Young 140 MP / 24 Vdc - CRI 80

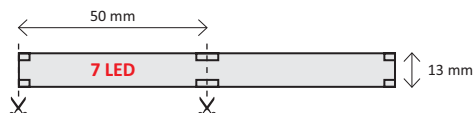

### YOUNG 140 MP / 24 Vdc — CRI 90



CODE CODICE	IP	POWER POTENZA	FLUX FLUSSO	VOLTAGE VOLTAGGIO	LEDs/m	COLOUR COLORE	CRI	MAX LENGTH** MAX LUNGHEZZA**	E.E. CLASS
MESTBFM2CBRB0	IP 00	12 W/m	1227 Lm/m	24 Vdc	140	2200K	90	5 m	A+
MESTBFM2CJB0	IP 00	12 W/m	1532 Lm/m	24 Vdc	140	2700K	90	5 m	A++
MESTBFM2CBK0	IP 00	12 W/m	1532 Lm/m	24 Vdc	140	3000K	90	5 m	A++
MESTBFM2CBL0	IP 00	12 W/m	1578 Lm/m	24 Vdc	140	4000K	90	5 m	A++
MESTBFM2CB30	IP 00	12 W/m	1610 Lm/m	24 Vdc	140	5700K	90	5 m	A++

Dimmable using dedicated controls.

\*\* Maximum strip length with same power cable.

**MODULE BY 500 mm**  
Young 140 MP / 24 Vdc - CRI 90

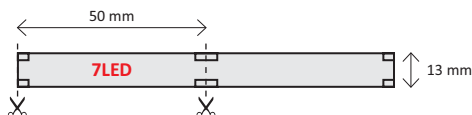

### YOUNG 140 MP / 48 Vdc — CRI 80



CODE CODICE	IP	POWER POTENZA	FLUX FLUSSO	VOLTAGE VOLTAGGIO	LEDs/m	COLOUR COLORE	CRI	MAX LENGTH** MAX LUNGHEZZA**	E.E. CLASS
MESTBFM2C6OC0	IP 00	12 W/m	1227 Lm/m	48 Vdc	140	2200K	80	7 m	A+
MESTBFM2C6PC0	IP 00	12 W/m	1363 Lm/m	48 Vdc	140	2500K	80	7 m	A+
MESTBFM2C6AC0	IP 00	12 W/m	1532 Lm/m	48 Vdc	140	2700K	80	7 m	A++
MESTBFM2C6BC0	IP 00	12 W/m	1532 Lm/m	48 Vdc	140	3000K	80	7 m	A++
MESTBFM2C6CC0	IP 00	12 W/m	1578 Lm/m	48 Vdc	140	4000K	80	7 m	A++
MESTBFM2C6WC0	IP 00	12 W/m	1610 Lm/m	48 Vdc	140	5700K	80	7 m	A++

Dimmable using dedicated controls.

\*\* Maximum strip length with same power cable.

**MODULE BY 500 mm**  
Young 140 MP / 48 Vdc - CRI 80

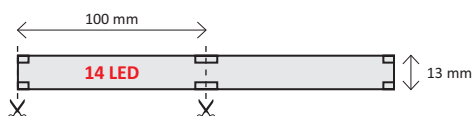

### YOUNG 140 MP / 48 Vdc — CRI 90



CODE CODICE	IP	POWER POTENZA	FLUX FLUSSO	VOLTAGE VOLTAGGIO	LEDs/m	COLOUR COLORE	CRI	MAX LENGTH** MAX LUNGHEZZA**	E.E. CLASS
MESTBFM2C6RC0	IP 00	12 W/m	1227 Lm/m	48 Vdc	140	2200K	90	7 m	A+
MESTBFM2C6JC0	IP 00	12 W/m	1532 Lm/m	48 Vdc	140	2700K	90	7 m	A++
MESTBFM2C6KC0	IP 00	12 W/m	1532 Lm/m	48 Vdc	140	3000K	90	7 m	A++
MESTBFM2C6LC0	IP 00	12 W/m	1578 Lm/m	48 Vdc	140	4000K	90	7 m	A++
MESTBFM2C63C0	IP 00	12 W/m	1610 Lm/m	48 Vdc	140	5700K	90	7 m	A++

Dimmable using dedicated controls.

\*\* Maximum strip length with same power cable.

**MODULE BY 500 mm**  
Young 140 MP / 48 Vdc - CRI 90

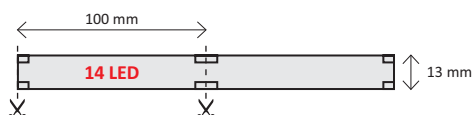

YOUNG 140 HP / 24 Vdc — CRI 80



CODE CODICE	IP	POWER POTENZA	FLUX FLUSSO	VOLTAGE VOLTAGGIO	LEDs/m	COLOUR COLORE	CRI	MAX LENGTH** MAX LUNGHEZZA**	E.E. CLASS
MESTBEMDCBOB0	IP 00	15 W/m	1580 Lm/m	24 Vdc	140	2200K	80	5 m	A+
MESTBEMDCBPB0	IP 00	15 W/m	1756 Lm/m	24 Vdc	140	2500K	80	5 m	A++
MESTBEMDCBAB0	IP 00	15 W/m	1973 Lm/m	24 Vdc	140	2700K	80	5 m	A++
MESTBEMDCBBB0	IP 00	15 W/m	1973 Lm/m	24 Vdc	140	3000K	80	5 m	A++
MESTBEMDCBCB0	IP 00	15 W/m	2032 Lm/m	24 Vdc	140	4000K	80	5 m	A++
MESTBEMDCBWB0	IP 00	15 W/m	2073 Lm/m	24 Vdc	140	5700K	80	5 m	A++

Dimmable using dedicated controls.

\*\* Maximum strip length with same power cable.

**MODULE BY 500 mm**  
Young 140 HP / 24 Vdc - CRI 80

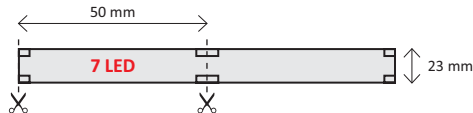

YOUNG 140 HP / 24 Vdc — CRI 90



CODE CODICE	IP	POWER POTENZA	FLUX FLUSSO	VOLTAGE VOLTAGGIO	LEDs/m	COLOUR COLORE	CRI	MAX LENGTH** MAX LUNGHEZZA**	E.E. CLASS
MESTBEMDCBRB0	IP 00	15 W/m	1580 Lm/m	24 Vdc	140	2200K	90	5 m	A+
MESTBEMDCBJB0	IP 00	15 W/m	1973 Lm/m	24 Vdc	140	2700K	90	5 m	A++
MESTBEMDCBKB0	IP 00	15 W/m	1973 Lm/m	24 Vdc	140	3000K	90	5 m	A++
MESTBEMDCBLB0	IP 00	15 W/m	2032 Lm/m	24 Vdc	140	4000K	90	5 m	A++
MESTBEMDCB3B0	IP 00	15 W/m	2073 Lm/m	24 Vdc	140	5700K	90	5 m	A++

Dimmable using dedicated controls.

\*\* Maximum strip length with same power cable.

**MODULE BY 500 mm**  
Young 140 HP / 24 Vdc - CRI 90

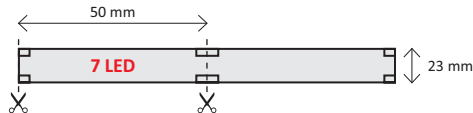



### YOUNG 140 HP / 48 Vdc — CRI 80



CODE CODICE	IP	POWER POTENZA	FLUX FLUSSO	VOLTAGE VOLTAGGIO	LEDs/m	COLOUR COLORE	CRI	MAX LENGTH** MAX LUNGHEZZA**	E.E. CLASS
MESTBEMDC6OC0	IP 00	15 W/m	1580 Lm/m	48 Vdc	140	2200K	80	15 m	A+
MESTBEMDC6PC0	IP 00	15 W/m	1756 Lm/m	48 Vdc	140	2500K	80	15 m	A++
MESTBEMDC6AC0	IP 00	15 W/m	1973 Lm/m	48 Vdc	140	2700K	80	15 m	A++
MESTBEMDC6BC0	IP 00	15 W/m	1973 Lm/m	48 Vdc	140	3000K	80	15 m	A++
MESTBEMDC6CC0	IP 00	15 W/m	2032 Lm/m	48 Vdc	140	4000K	80	15 m	A++
MESTBEMDC6WC0	IP 00	15 W/m	2073 Lm/m	48 Vdc	140	5700K	80	15 m	A++

Dimmable using dedicated controls.

\*\* Maximum strip length with same power cable.

**MODULE BY 500 mm**  
Young 140 HP / 48 Vdc - CRI 80

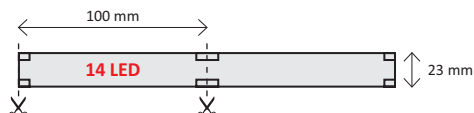

### YOUNG 140 HP / 48 Vdc — CRI 90



CODE CODICE	IP	POWER POTENZA	FLUX FLUSSO	VOLTAGE VOLTAGGIO	LEDs/m	COLOUR COLORE	CRI	MAX LENGTH** MAX LUNGHEZZA**	E.E. CLASS
MESTBEMDC6RC0	IP 00	15 W/m	1580 Lm/m	48 Vdc	140	2200K	90	15 m	A+
MESTBEMDC6JC0	IP 00	15 W/m	1973 Lm/m	48 Vdc	140	2700K	90	15 m	A++
MESTBEMDC6kC0	IP 00	15 W/m	1973 Lm/m	48 Vdc	140	3000K	90	15 m	A++
MESTBEMDC6LC0	IP 00	15 W/m	2032 Lm/m	48 Vdc	140	4000K	90	15 m	A++
MESTBEMDC63C0	IP 00	15 W/m	2073 Lm/m	48 Vdc	140	5700K	90	15 m	A++

Dimmable using dedicated controls.

\*\* Maximum strip length with same power cable.

**MODULE BY 500 mm**  
Young 140 HP / 48 Vdc - CRI 90

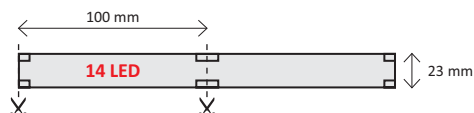

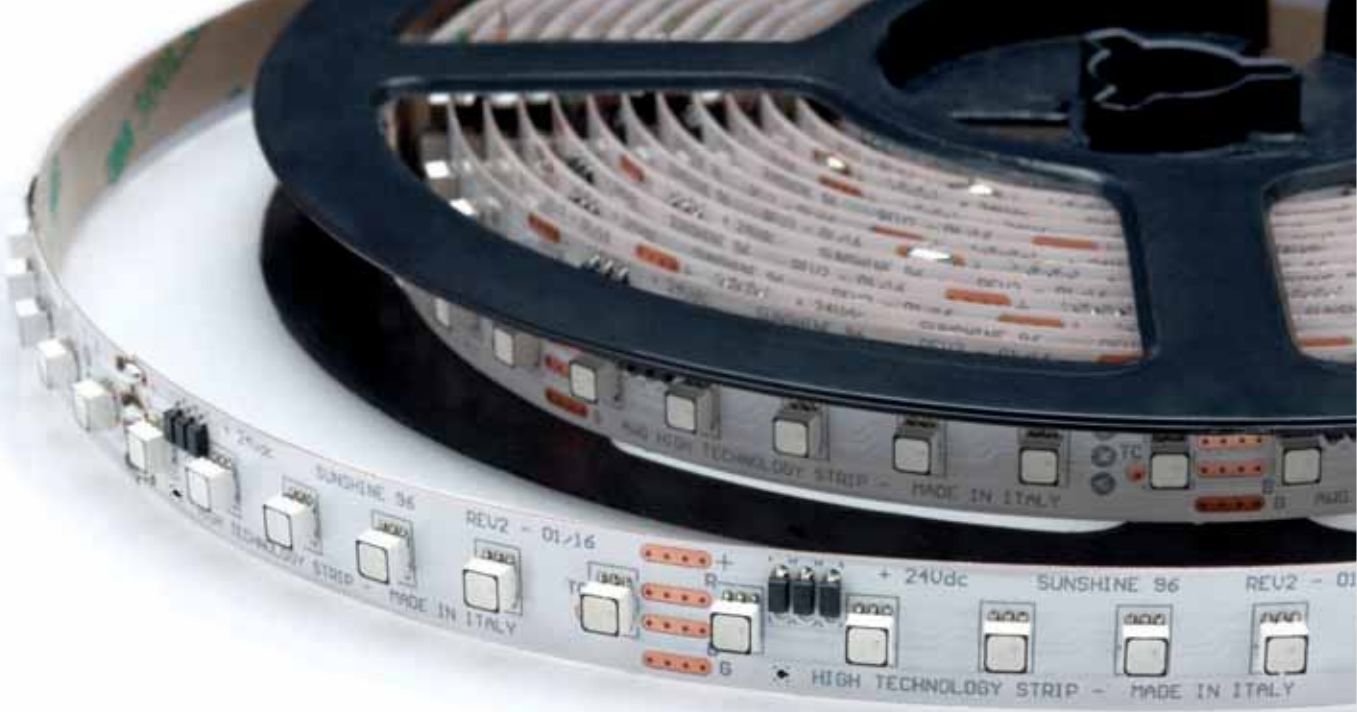

# FULL COLOR

## SUNSHINE 72 / 24 Vdc



CODE CODICE	IP	POWER POTENZA	FLUX FLUSSO	VOLTAGE VOLTAGGIO	LEDs/m	COLOUR COLORE	CRI	MAX LENGTH** MAX LUNGHEZZA**	E.E. CLASS
MESTF1B3E8EVO	IP 00	14,4 W/m	610 Lm/m	24 Vdc	72	RGB	—	5 m	A

Dimmable using dedicated controls.

\*\* Maximum strip length with same power cable.

REEL 5 m  
Sunshine 72 / 24 Vdc

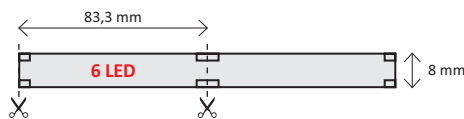

## SUNSHINE 96 / 24 Vdc



CODE CODICE	IP	POWER POTENZA	FLUX FLUSSO	VOLTAGE VOLTAGGIO	LEDs/m	COLOUR COLORE	CRI	MAX LENGTH** MAX LUNGHEZZA**	E.E. CLASS
MESTFFJCF9EBO	IP 00	19 W/m	750 Lm/m	24 Vdc	96	RGB	—	5 m	A

Dimmable using dedicated controls.

\*\* Maximum strip length with same power cable.

REEL 5 m  
Sunshine 96 / 24 Vdc

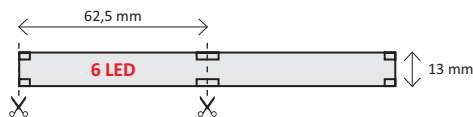

## SUNSHINE 96 / 48 Vdc



CODE CODICE	IP	POWER POTENZA	FLUX FLUSSO	VOLTAGE VOLTAGGIO	LEDs/m	COLOUR COLORE	CRI	MAX LENGTH** MAX LUNGHEZZA**	E.E. CLASS
MESTFFJCF9EBO	IP 00	19 W/m	750 Lm/m	48 Vdc	96	RGB	—	10 m	A

Dimmable using dedicated controls.

\*\* Maximum strip length with same power cable.

REEL 5 m  
Sunshine 96 / 48 Vdc

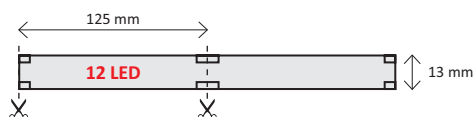

**Full Color strip is a collection of RGB products specific for those looking for quality at an affordable price.**

The 5 m long reels of the Full Color collection with either 72 or 96 LEDs/m. Full Color is adjustable using the series of controls and standard power supplies listed in the specific sections. Complete with 3M double-sided tape.

*Full Color strip è una collezione di prodotti RGB dedicata a chi cerca qualità ad un prezzo contenuto.*

*Le bobine della collezione Full Color sono lunghe 5 m nelle tipologie 72 e 96 LED/m. Full Color è regolabile attraverso la linea di controlli e alimentatori a norma lighting proposti nelle sezioni dedicate. Completa di biadesivo 3M.*



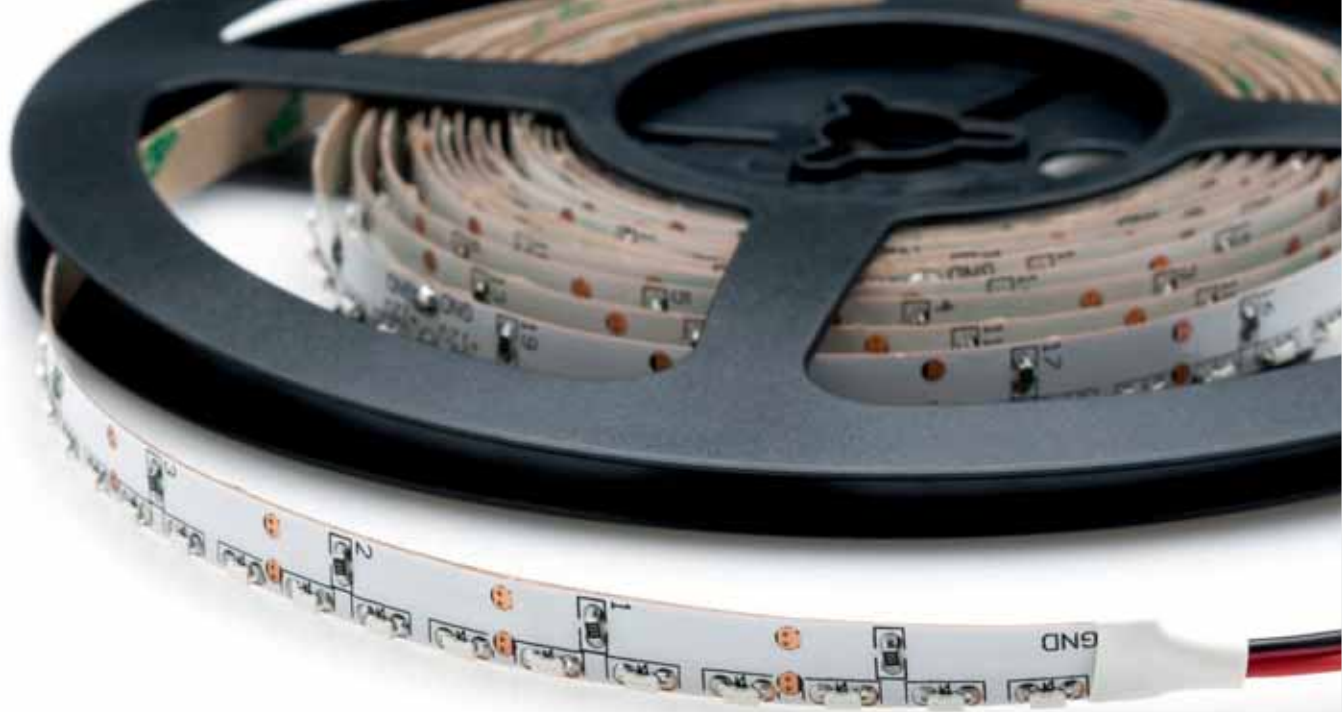

# SIDE EMITTING

## SIDE EMITTING 96 / 24 Vdc



CODE CODICE	IP	POWER POTENZA	FLUX FLUSSO	VOLTAGE VOLTAGGIO	LEDs/m	COLOUR COLORE	CRI	MAX LENGTH** MAX LUNGHEZZA**	E.E. CLASS
MESTF9J8N9AB0	IP 00	7 W/m	741 Lm/m	24 Vdc	96	2700K	80	5 m	A+
MESTF9J8N9BB0	IP 00	7 W/m	741 Lm/m	24 Vdc	96	3000K	80	5 m	A+
MESTF9J8N9CB0	IP 00	7 W/m	763 Lm/m	24 Vdc	96	4000K	80	5 m	A+
MESTF9J8N9WB0	IP 00	7 W/m	778 Lm/m	24 Vdc	96	5700K	80	5 m	A+

Dimmable using dedicated controls.

\*\* Maximum strip length with same power cable.

REEL 5 m  
Side emitting 96 / 24 Vdc

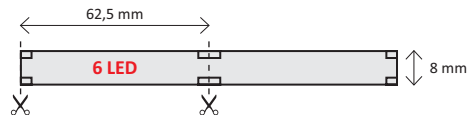

## SIDE EMITTING 96 / 24 Vdc WATERPROOF — IP 65



CODE CODICE	IP	POWER POTENZA	FLUX FLUSSO	VOLTAGE VOLTAGGIO	LEDs/m	COLOUR COLORE	CRI	MAX LENGTH** MAX LUNGHEZZA**	E.E. CLASS
MESTW9J8N9AB0	IP 65	7 W/m	741 Lm/m	24 Vdc	96	2700K	80	5 m	A
MESTW9J8N9BB0	IP 65	7 W/m	741 Lm/m	24 Vdc	96	3000K	80	5 m	A
MESTW9J8N9CB0	IP 65	7 W/m	763 Lm/m	24 Vdc	96	4000K	80	5 m	A
MESTW9J8N9WB0	IP 65	7 W/m	778 Lm/m	24 Vdc	96	5700K	80	5 m	A

Dimmable using dedicated controls.

\*\* Maximum strip length with same power cable.

REEL 5 m  
Side emitting 96 / 24 Vdc IP65

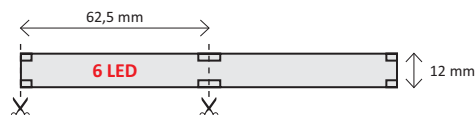

## SIDE EMITTING GUIDE

### Power cable position

#### WARNING!

In the case of custom wiring, please specify whether the power cable is on the right or on the left.

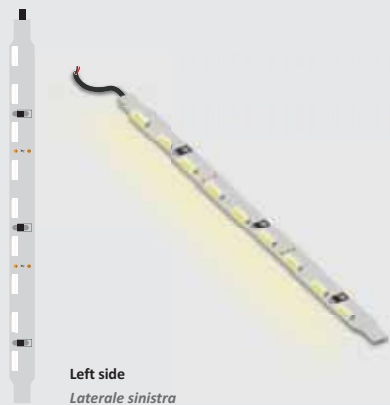

## GUIDA ALLA SIDE EMITTING

### Posizione dell'alimentazione

#### ATTENZIONE!

Nel caso di cablaggio su misura si prega di specificare se l'alimentazione è a destra o a sinistra.





# KING

## KING 56 / 24 Vdc — 23 W — CRI 80



CODE CODICE	IP	POWER POTENZA	FLUX FLUSSO	VOLTAGE VOLTAGGIO	LEDs/m	COLOUR COLORE	CRI	MAX LENGTH** MAX LUNGHEZZA**	E.E. CLASS
MESTAHRIFFOBO	IP 00	23 W/m	2470 Lm/m	24 Vdc	56	2200K	80	5 m	A
MESTAHRIFFPBO	IP 00	23 W/m	2745 Lm/m	24 Vdc	56	2500K	80	5 m	A
MESTAHRIIFABO	IP 00	23 W/m	3084 Lm/m	24 Vdc	56	2700K	80	5 m	A+
MESTAHRIIFBBO	IP 00	23 W/m	3084 Lm/m	24 Vdc	56	3000K	80	5 m	A+
MESTAHRIIFCBO	IP 00	23 W/m	3177 Lm/m	24 Vdc	56	4000K	80	5 m	A+
MESTAHRIIFWBO	IP 00	23 W/m	3240 Lm/m	24 Vdc	56	5700K	80	5 m	A+

Dimmable using dedicated controls.

\*\* Maximum strip length with same power cable.

### MODULE BY 500 mm

King 56 / 24 Vdc - 23 W - CRI 80

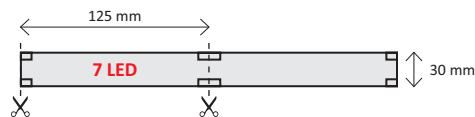

## KING 56 / 24 Vdc — 23 W — CRI 90



CODE CODICE	IP	POWER POTENZA	FLUX FLUSSO	VOLTAGE VOLTAGGIO	LEDs/m	COLOUR COLORE	CRI	MAX LENGTH** MAX LUNGHEZZA**	E.E. CLASS
MESTAHRIIFJBO	IP 00	23 W/m	2375 Lm/m	24 Vdc	56	2700K	90	5 m	A
MESTAHRIIFKBO	IP 00	23 W/m	2375 Lm/m	24 Vdc	56	3000K	90	5 m	A
MESTAHRIIFLBO	IP 00	23 W/m	2446 Lm/m	24 Vdc	56	4000K	90	5 m	A
MESTAHRIIF3BO	IP 00	23 W/m	2495 Lm/m	24 Vdc	56	5700K	90	5 m	A

Dimmable using dedicated controls.

\*\* Maximum strip length with same power cable.

### MODULE BY 500 mm

King 56 / 24 Vdc - 23 W - CRI 90

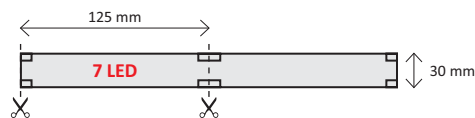

**A rigid module which guarantees very high luminous efficiency** (over 160 Lm/w) **and power** (up to 35 W/m).

The modules are made with metal core support which ensures very high heat dissipation and durability of the product. King is available with IRC 80 and 90 or with powered coloured LEDs: red, yellow, green, blue, ocher.

*Modulo rigido che garantisce un'altissima efficienza luminosa (superiore a 160 Lm/w) e potenza (fino 35 W/m).*

*I moduli sono realizzati con supporto metal core che assicura dissipazione elevatissima e durabilità del prodotto. King è disponibile con CRI 80 e 90 o con LED di potenza colorati: rosso, giallo, verde, blu, ocra.*



## KING 56S / 24 Vdc — 17 W — CRI 80



CODE CODICE	IP	POWER POTENZA	FLUX FLUSSO	VOLTAGE VOLTAGGIO	LEDs/m	COLOUR COLORE	CRI	MAX LENGTH** MAX LUNGHEZZA**	E.E. CLASS
MESTA4RCFFOBO	IP 00	17 W/m	1206 Lm/m	24 Vdc	56	2200K	80	5 m	A
MESTA4RCFFPB0	IP 00	17 W/m	1340 Lm/m	24 Vdc	56	2500K	80	5 m	A
MESTA4RCIFAB0	IP 00	17 W/m	1506 Lm/m	24 Vdc	56	2700K	80	5 m	A+
MESTA4RCIFBBO	IP 00	17 W/m	1506 Lm/m	24 Vdc	56	3000K	80	5 m	A+
MESTA4RCIFCB0	IP 00	17 W/m	1551 Lm/m	24 Vdc	56	4000K	80	5 m	A+
MESTA4RCIFWB0	IP 00	17 W/m	1582 Lm/m	24 Vdc	56	5700K	80	5 m	A+

Dimmable using dedicated controls.

\*\* Maximum strip length with same power cable.

### MODULE BY 500 mm

King 56S / 24 Vdc - 17 W - CRI 80

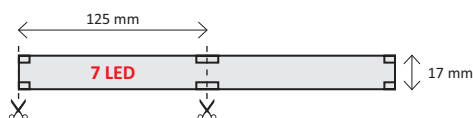

## KING 56S / 24 Vdc — 17 W — CRI 90



CODE CODICE	IP	POWER POTENZA	FLUX FLUSSO	VOLTAGE VOLTAGGIO	LEDs/m	COLOUR COLORE	CRI	MAX LENGTH** MAX LUNGHEZZA**	E.E. CLASS
MESTA4RCIFJBO	IP 00	17 W/m	1160 Lm/m	24 Vdc	56	2700K	90	5 m	A
MESTA4RCIFKB0	IP 00	17 W/m	1194 Lm/m	24 Vdc	56	3000K	90	5 m	A
MESTA4RCIFLBO	IP 00	17 W/m	1194 Lm/m	24 Vdc	56	4000K	90	5 m	A
MESTA4RCIF3BO	IP 00	17 W/m	1218 Lm/m	24 Vdc	56	5700K	90	5 m	A

Dimmable using dedicated controls.

\*\* Maximum strip length with same power cable.

### MODULE BY 500 mm

King 56S / 24 Vdc - 17 W - CRI 90

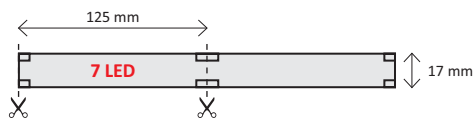

## KING 112S / 24 Vdc — 23 W — CRI 80



CODE CODICE	IP	POWER POTENZA	FLUX FLUSSO	VOLTAGE VOLTAGGIO	LEDs/m	COLOUR COLORE	CRI	MAX LENGTH** MAX LUNGHEZZA**	E.E. CLASS
MESTA4QIF9OB0	IP 00	23 W/m	2390 Lm/m	24 Vdc	112	2200K	80	5 m	A+
MESTA4QIF9PB0	IP 00	23 W/m	2656 Lm/m	24 Vdc	112	2500K	80	5 m	A++
MESTA4QII9AB0	IP 00	23 W/m	2984 Lm/m	24 Vdc	112	2700K	80	5 m	A++
MESTA4QII9BB0	IP 00	23 W/m	2984 Lm/m	24 Vdc	112	3000K	80	5 m	A++
MESTA4QII9CB0	IP 00	23 W/m	3074 Lm/m	24 Vdc	112	4000K	80	5 m	A++
MESTA4QII9WB0	IP 00	23 W/m	3135 Lm/m	24 Vdc	112	5700K	80	5 m	A++

Dimmable using dedicated controls.

\*\* Maximum strip length with same power cable.

## MODULE BY 500 mm

King 112S / 24 Vdc - 23 W - CRI 80

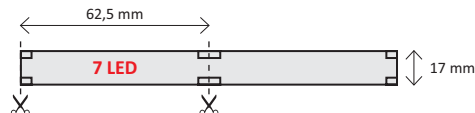

## KING 112S / 24 Vdc — 23 W — CRI 90



CODE CODICE	IP	POWER POTENZA	FLUX FLUSSO	VOLTAGE VOLTAGGIO	LEDs/m	COLOUR COLORE	CRI	MAX LENGTH** MAX LUNGHEZZA**	E.E. CLASS
MESTA4QII9JB0	IP 00	23 W/m	2298 Lm/m	24 Vdc	112	2700K	90	5 m	A+
MESTA4QII9KB0	IP 00	23 W/m	2298 Lm/m	24 Vdc	112	3000K	90	5 m	A+
MESTA4QII9LB0	IP 00	23 W/m	2367 Lm/m	24 Vdc	112	4000K	90	5 m	A+
MESTA4QII93B0	IP 00	23 W/m	2414 Lm/m	24 Vdc	112	5700K	90	5 m	A+

Dimmable using dedicated controls.

\*\* Maximum strip length with same power cable.

## MODULE BY 500 mm

King 112S / 24 Vdc - 23 W - CRI 90

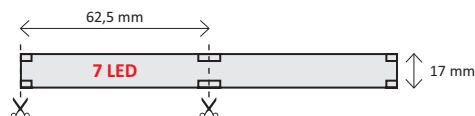



## KING 112S / 48 Vdc — 23 W — CRI 80



CODE CODICE	IP	POWER POTENZA	FLUX FLUSSO	VOLTAGE VOLTAGGIO	LEDs/m	COLOUR COLORE	CRI	MAX LENGTH** MAX LUNGHEZZA**	E.E. CLASS
MESTA4QIFFOCO	IP 00	23 W/m	2390 Lm/m	48 Vdc	112	2200K	80	10 m	A+
MESTA4QIFFPCO	IP 00	23 W/m	2656 Lm/m	48 Vdc	112	2500K	80	10 m	A++
MESTA4QIIFACO	IP 00	23 W/m	2984 Lm/m	48 Vdc	112	2700K	80	10 m	A++
MESTA4QIIFBCO	IP 00	23 W/m	2984 Lm/m	48 Vdc	112	3000K	80	10 m	A++
MESTA4QIIFCCO	IP 00	23 W/m	3074 Lm/m	48 Vdc	112	4000K	80	10 m	A++
MESTA4QIIFWCO	IP 00	23 W/m	3135 Lm/m	48 Vdc	112	5700K	80	10 m	A++

Dimmable using dedicated controls.

\*\* Maximum strip length with same power cable.

## MODULE BY 500 mm

King 112S / 48 Vdc - 23 W - CRI 80

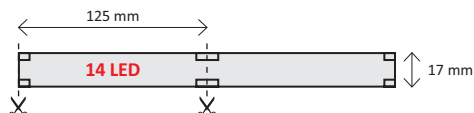

## KING 112S / 48 Vdc — 23 W — CRI 90



CODE CODICE	IP	POWER POTENZA	FLUX FLUSSO	VOLTAGE VOLTAGGIO	LEDs/m	COLOUR COLORE	CRI	MAX LENGTH** MAX LUNGHEZZA**	E.E. CLASS
MESTA4QIIFJCO	IP 00	23 W/m	2298 Lm/m	48 Vdc	112	2700K	90	10 m	A+
MESTA4QIIFKCO	IP 00	23 W/m	2298 Lm/m	48 Vdc	112	3000K	90	10 m	A+
MESTA4QIIFLCO	IP 00	23 W/m	2367 Lm/m	48 Vdc	112	4000K	90	10 m	A+
MESTA4QIIF3CO	IP 00	23 W/m	2414 Lm/m	48 Vdc	112	5700K	90	10 m	A+

Dimmable using dedicated controls.

\*\* Maximum strip length with same power cable.

## MODULE BY 500 mm

King 112S / 48 Vdc - 23 W - CRI 90

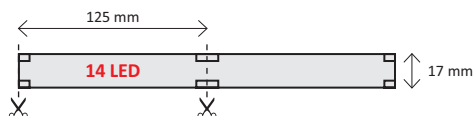



# IRON 6

IRON 6 / 24 Vdc



CODE CODICE	LENS LENTI	IP	POWER POTENZA	FLUX FLUSSO	VOLTAGE VOLTAGGIO	LEDs/m	COLOUR COLORE	CRI	MAX LENGTH** MAX LUNGHEZZA**	E.E. CLASS
MESTA4TPFGAB0	-	IP 00	9 W/module	3300 Lm/m	24 Vdc	6	2700K	80	5 m	A+
MESTA4TPFGAL1	55°	IP 00	9 W/module	3300 Lm/m	24 Vdc	6	2700K	80	5 m	A+
MESTA4TPFGAL2	30°	IP 00	9 W/module	3300 Lm/m	24 Vdc	6	2700K	80	5 m	A+
MESTA4TPFGAL3	18°	IP 00	9 W/module	3300 Lm/m	24 Vdc	6	2700K	80	5 m	A+
MESTA4TPFGAL4	32°+14°	IP 00	9 W/module	3300 Lm/m	24 Vdc	6	2700K	80	5 m	A+
MESTA4TPFGBB0	-	IP 00	9 W/module	3300 Lm/m	24 Vdc	6	3000K	80	5 m	A+
MESTA4TPFGBL1	55°	IP 00	9 W/module	3300 Lm/m	24 Vdc	6	3000K	80	5 m	A+
MESTA4TPFGBL2	30°	IP 00	9 W/module	3300 Lm/m	24 Vdc	6	3000K	80	5 m	A+
MESTA4TPFGBL3	18°	IP 00	9 W/module	3300 Lm/m	24 Vdc	6	3000K	80	5 m	A+
MESTA4TPFGBL4	32°+14°	IP 00	9 W/module	3300 Lm/m	24 Vdc	6	3000K	80	5 m	A+
MESTA4TPFGCB0	-	IP 00	9 W/module	3360 Lm/m	24 Vdc	6	4000K	80	5 m	A+
MESTA4TPFGCL1	55°	IP 00	9 W/module	3360 Lm/m	24 Vdc	6	4000K	80	5 m	A+
MESTA4TPFGCL2	30°	IP 00	9 W/module	3360 Lm/m	24 Vdc	6	4000K	80	5 m	A+
MESTA4TPFGCL3	18°	IP 00	9 W/module	3360 Lm/m	24 Vdc	6	4000K	80	5 m	A+
MESTA4TPFGCL4	32°+14°	IP 00	9 W/module	3360 Lm/m	24 Vdc	6	4000K	80	5 m	A+
MESTA4TPFGWB0	-	IP 00	9 W/module	3420 Lm/m	24 Vdc	6	5700K	80	5 m	A+
MESTA4TPFGWL1	55°	IP 00	9 W/module	3420 Lm/m	24 Vdc	6	5700K	80	5 m	A+
MESTA4TPFGWL2	30°	IP 00	9 W/module	3420 Lm/m	24 Vdc	6	5700K	80	5 m	A+
MESTA4TPFGWL3	18°	IP 00	9 W/module	3420 Lm/m	24 Vdc	6	5700K	80	5 m	A+
MESTA4TPFGWL4	32°+18°	IP 00	9 W/module	3420 Lm/m	24 Vdc	6	5700K	80	5 m	A+

Dimmable using dedicated controls.

\*\* Maximum strip length with same power cable.

MODULE BY 280 mm  
Iron 6 / 24 Vdc

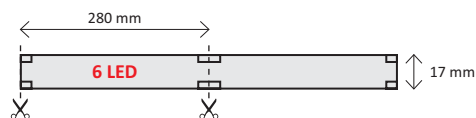

**Printed circuit made with high power LED on aluminium stand.**

The module is designed for mounting of lenses with angles of 18°, 30°, 55° and oval for "Wall Washer" applications. Powered at 24 Vdc and interconnectable with other modules through quick connectors, dimmable in PWM with compatible logic levels up to 24 Vdc. Fixing: by screw.

***Circuito stampato realizzato con high power LED su supporto in alluminio.***

*La scheda è predisposta per l'alloggiamento di lenti con angoli da 18°, 30°, 55° e ovale per applicazioni "Wall Washer". Alimentabile a 24 Vdc e interconnettibile ad altri moduli tramite connettori ad innesto rapido, dimmerabile in PWM con livelli logici compatibili fino a 24 Vdc. Fissaggio tramite vite.*



# EASY LINE STRIPS

<b>EASY STANDARD</b>	p. 316
<b>EASY PLUS</b>	p. 320
<b>EASY RGB &amp; RGBW</b>	p. 322
<b>STRIPS ACCESSORIES</b>	p. 324
<b>MOUNTING GUIDE</b>	p. 325

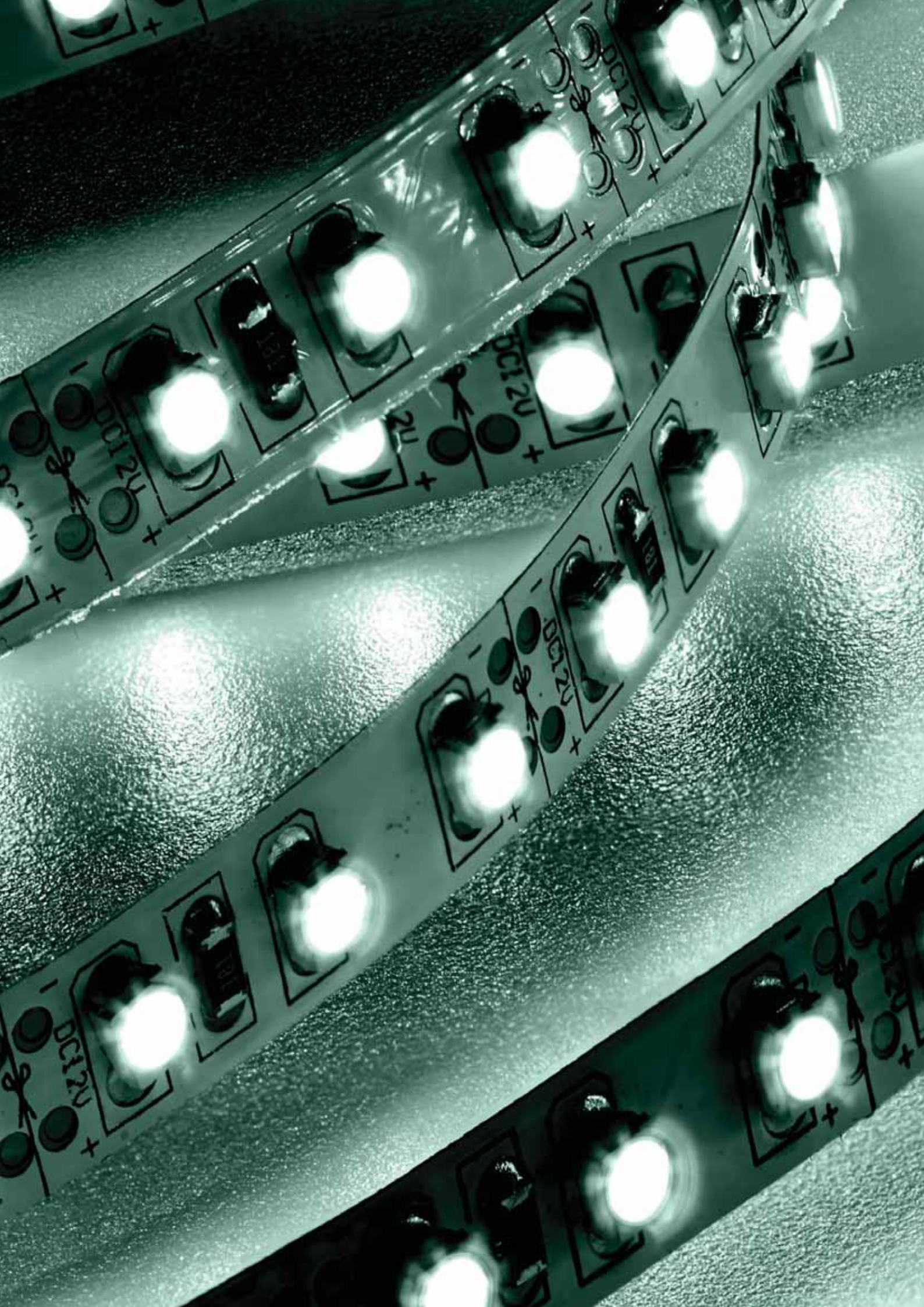



# EASY STANDARD

## EASY 5050-60 / 24 Vdc



CODE CODICE	IP	POWER POTENZA	FLUX FLUSSO	VOLTAGE VOLTAGGIO	LEDs/m	COLOUR COLORE	CRI	MAX LENGTH** MAX LUNGHEZZA**	E.E. CLASS
WA24I5006060	IP 00	14,4 W/m	1020 Lm/m	24 Vdc	60	2800-3000K	80	5 m	A
WA24I5006055	IP 00	14,4 W/m	1070 Lm/m	24 Vdc	60	4000-4250K	80	5 m	A
WA24I5006070	IP 00	14,4 W/m	1140 Lm/m	24 Vdc	60	6000-6500K	80	5 m	A

Dimmable using dedicated controls.

\*\* Maximum strip length with same power cable.

REEL 5 m  
Easy 5050-60 / 24 Vdc

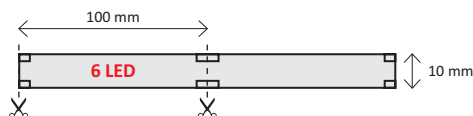

## EASY 5050-60 / 24 Vdc WATERPROOF — IP 65



CODE CODICE	IP	POWER POTENZA	FLUX FLUSSO	VOLTAGE VOLTAGGIO	LEDs/m	COLOUR COLORE	CRI	MAX LENGTH** MAX LUNGHEZZA**	E.E. CLASS
WA24W5006060	IP 65	14,4 W/m	1020 Lm/m	24 Vdc	60	2800-3000K	80	5 m	A
WA24W5006055	IP 65	14,4 W/m	1070 Lm/m	24 Vdc	60	4000-4250K	80	5 m	A
WA24W5006070	IP 65	14,4 W/m	1140 Lm/m	24 Vdc	60	6000-6500K	80	5 m	A

Dimmable using dedicated controls.

\*\* Maximum strip length with same power cable.

REEL 5 m  
Easy 5050-60 / 24 Vdc IP65

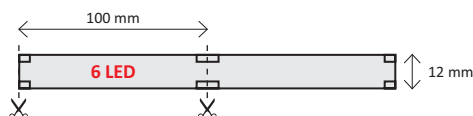

The Easy Standard collection lists the most used powers and sizes on the market, paying particular attention to the efficiency and product quality.

La collezione Easy Standard propone le potenze e le taglie più usate nel mercato con particolare attenzione all'efficienza e alla qualità del prodotto.



## EASY 3528-120 / 24 Vdc



CODE CODICE	IP	POWER POTENZA	FLUX FLUSSO	VOLTAGE VOLTAGGIO	LEDs/m	COLOUR COLORE	CRI	MAX LENGTH** MAX LUNGHEZZA**	E.E. CLASS
WA24I0012050	IP 00	9,6 W/m	740 Lm/m	24 Vdc	120	2700-2850K	80	5 m	A
WA24I0012060	IP 00	9,6 W/m	780 Lm/m	24 Vdc	120	2850-3000K	80	5 m	A
WA24I0012055	IP 00	9,6 W/m	830 Lm/m	24 Vdc	120	4000-4250K	80	5 m	A
WA24I0012070	IP 00	9,6 W/m	870 Lm/m	24 Vdc	120	6000-6500K	80	5 m	A

Dimmable using dedicated controls.

\*\* Maximum strip length with same power cable.

REEL 5 m  
Easy 3528-120 / 24 Vdc

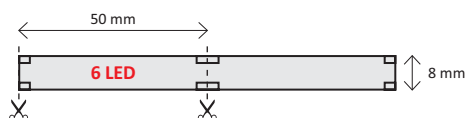

## EASY 3528-120 / 24 Vdc WATERPROOF — IP 65



CODE CODICE	IP	POWER POTENZA	FLUX FLUSSO	VOLTAGE VOLTAGGIO	LEDs/m	COLOUR COLORE	CRI	MAX LENGTH** MAX LUNGHEZZA**	E.E. CLASS
WA24W0012050	IP 65	9,6 W/m	740 Lm/m	24 Vdc	120	2700-2850K	80	5 m	A
WA24W0012060	IP 65	9,6 W/m	780 Lm/m	24 Vdc	120	2850-3000K	80	5 m	A
WA24W0012055	IP 65	9,6 W/m	830 Lm/m	24 Vdc	120	4000-4250K	80	5 m	A
WA24W0012070	IP 65	9,6 W/m	870 Lm/m	24 Vdc	120	6000-6500K	80	5 m	A

Dimmable using dedicated controls.

\*\* Maximum strip length with same power cable.

REEL 5 m  
Easy 3528-120 / 24 Vdc IP65

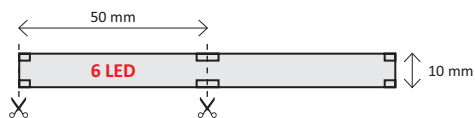

## EASY 3528-120 COLORS / 24 Vdc



CODE CODICE	IP	POWER POTENZA	FLUX FLUSSO	VOLTAGE VOLTAGGIO	LEDs/m	COLOUR COLORE	CRI	MAX LENGTH** MAX LUNGHEZZA**	E.E. CLASS
WA24I0012090	IP 00	9,6 W/m	—	24 Vdc	120	blue led	—	5 m	A
WA24I0012091	IP 00	9,6 W/m	—	24 Vdc	120	green led	—	5 m	A
WA24I0012092	IP 00	9,6 W/m	—	24 Vdc	120	red led	—	5 m	A

Dimmable using dedicated controls.

\*\* Maximum strip length with same power cable.

REEL 5 m  
Easy 3528-120 colors / 24 Vdc

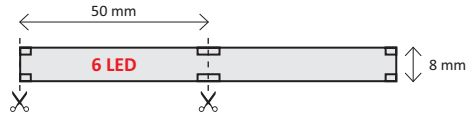

## EASY 3528-120 COLORS / 24 Vdc WATERPROOF — IP 65



CODE CODICE	IP	POWER POTENZA	FLUX FLUSSO	VOLTAGE VOLTAGGIO	LEDs/m	COLOUR COLORE	CRI	MAX LENGTH** MAX LUNGHEZZA**	E.E. CLASS
WA24W0012090	IP 65	9,6 W/m	—	24 Vdc	120	blue led	—	5 m	A
WA24W0012091	IP 65	9,6 W/m	—	24 Vdc	120	green led	—	5 m	A
WA24W0012092	IP 65	9,6 W/m	—	24 Vdc	120	red led	—	5 m	A

Dimmable using dedicated controls.

\*\* Maximum strip length with same power cable.

REEL 5 m  
Easy 3528-120 colors / 24 Vdc IP65

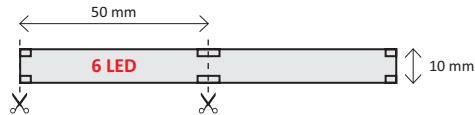



## MICRO EASY 3528-120 COLORS / 24 Vdc



CODE CODICE	IP	POWER POTENZA	FLUX FLUSSO	VOLTAGE VOLTAGGIO	LEDs/m	COLOUR COLORE	CRI	MAX LENGTH** MAX LUNGHEZZA**	E.E. CLASS
WA24I0012093	IP 00	9,6 W/m	-	24 Vdc	120	blue led	-	5 m	A
WA24I0012094	IP 00	9,6 W/m	-	24 Vdc	120	green led	-	5 m	A
WA24I0012095	IP 00	9,6 W/m	-	24 Vdc	120	red led	-	5 m	A

Dimmable using dedicated controls.

\*\* Maximum strip length with same power cable.

REEL 5 m  
Micro Easy 3528-120 colors / 24 Vdc

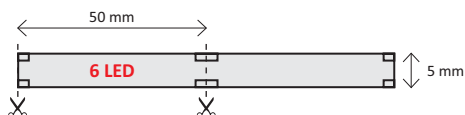

## MICRO EASY 2216-120 / 24 Vdc



CODE CODICE	IP	POWER POTENZA	FLUX FLUSSO	VOLTAGE VOLTAGGIO	LEDs/m	COLOUR COLORE	CRI	MAX LENGTH** MAX LUNGHEZZA**	E.E. CLASS
WA24I30120452	IP00	7 W/m	580 Lm/m	24V	120	2200-2400K	80	3 m	A
WA24I30120502	IP00	7 W/m	630 Lm/m	24V	120	2700-3000K	80	3 m	A
WA24I30120602	IP00	7 W/m	648 Lm/m	24V	120	3000-3200K	80	3 m	A
WA24I30120552	IP00	7 W/m	700 Lm/m	24V	120	4000-4100K	80	3 m	A
WA24I30120702	IP00	7 W/m	710 Lm/m	24V	120	6000-6100K	80	3 m	A

Dimmable using dedicated controls.

\*\* Maximum strip length with same power cable.

REEL 5 m  
Microeasy 120-2216 / 24 Vdc

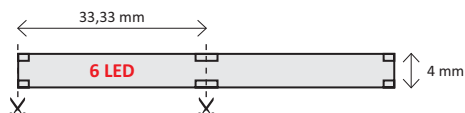



# EASY PLUS

## EASY 2835-96 / 24 Vdc



CODE CODICE	IP	POWER POTENZA	FLUX FLUSSO	VOLTAGE VOLTAGGIO	LEDs/m	COLOUR COLORE	CRI	MAX LENGTH** MAX LUNGHEZZA**	E.E. CLASS
WA24I2009650	IP 00	20 W/m	1550 Lm/m	24 Vdc	96	2700-2850K	80	5 m	A
WA24I2009660	IP 00	20 W/m	1840 Lm/m	24 Vdc	96	2850-3000K	80	5 m	A
WA24I2009655	IP 00	20 W/m	2070 Lm/m	24 Vdc	96	4000-4250K	80	5 m	A
WA24I2009670	IP 00	20 W/m	2070 Lm/m	24 Vdc	96	6000-6500K	80	5 m	A

Dimmable using dedicated controls.

\*\* Maximum strip length with same power cable.

REEL 5 m  
Easy 2835-96 / 24 Vdc

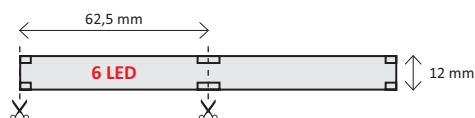

This product features an excellent relationship between number of LEDs, emission, power and cost. Suitable for primary lighting.

*Questo prodotto presenta un ottimo rapporto tra numero di LED, emissione, potenza e costo. Adatto ad illuminazione primaria.*

## EASY 3528-120 DYNAMIC WHITE / 24 Vdc



CODE CODICE	IP	POWER POTENZA	FLUX FLUSSO	VOLTAGE VOLTAGGIO	LEDs/m	COLOUR COLORE	CRI	MAX LENGTH** MAX LUNGHEZZA**	E.E. CLASS
WA24I0012075	IP 00	20 W/m	850 Lm/m	24 Vdc	120	LED DW	80	5 m	A

Tone variation possible using dedicated controls.

\*\* Maximum strip length with same power cable.

REEL 5 m  
Easy 3528-120 Dynamic White / 24 Vdc

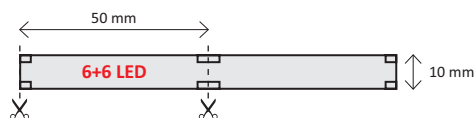

LED strip suitable for creating colour-change effects using special controls (described in the specific section).

*Strip LED idonea alla realizzazione di effetti di variazione cromatica attraverso l'uso di controlli adeguati (proposti nell'apposita sezione).*

The Easy collection Plus lists strips that ensure colour effects of power and uniformity, so to satisfy the more demanding needs.

*La collezione Easy Plus propone strip che assicurano effetti cromatici di potenza e uniformità, così da soddisfare le richieste più esigenti.*



## EASY 3528-180 / 24 Vdc



CODE CODICE	IP	POWER POTENZA	FLUX FLUSSO	VOLTAGE VOLTAGGIO	LEDs/m	COLOUR COLORE	CRI	MAX LENGTH** MAX LUNGHEZZA**	E.E. CLASS
WA24I0018050	IP 00	15 W/m	1240 Lm/m	24 Vdc	180	2700-2850K	80	5 m	A
WA24I0018065	IP 00	15 W/m	1270 Lm/m	24 Vdc	180	2850-3000K	80	5 m	A
WA24I0018055	IP 00	15 W/m	1310 Lm/m	24 Vdc	180	4000-4250K	80	5 m	A
WA24I0018070	IP 00	15 W/m	1360 Lm/m	24 Vdc	180	6000-6500K	80	5 m	A

Dimmable using dedicated controls.

\*\* Maximum strip length with same power cable.

REEL 5 m  
Easy 3528-180 / 24 Vdc

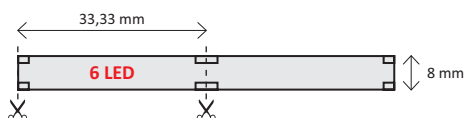



# EASY RGB & RGBW

## EASY 3528-120 RGBW / 24 Vdc



CODE CODICE	IP	POWER POTENZA	FLUX FLUSSO	VOLTAGE VOLTAGGIO	LEDs/m	COLOUR COLORE	CRI	MAX LENGTH** MAX LUNGHEZZA**	E.E. CLASS
WA24I0012081	IP 00	20 W/m	750 Lm/m	24 Vdc	120	RGBW	80	5 m	A

Colour-change function managed using dedicated controls.

\*\* Maximum strip length with same power cable.

REEL 5 m  
Easy 3528-120 RGBW / 24 Vdc

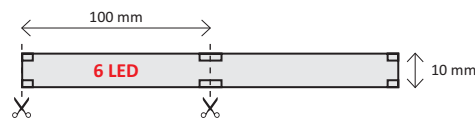

LED strip that in just one product delivers light emissions including both the RGB colour components and warm white.

*Strip LED che consente di ottenere in un unico prodotto, oltre alle componenti RGB, un bianco caldo dalle emissioni cromatiche.*

## EASY 5050-60 RGB / 24 Vdc



CODE CODICE	IP	POWER POTENZA	FLUX FLUSSO	VOLTAGE VOLTAGGIO	LEDs/m	COLOUR COLORE	CRI	MAX LENGTH** MAX LUNGHEZZA**	E.E. CLASS
WA24I5006080	IP 00	14,4 W/m	510 Lm/m	24 Vdc	60	RGB	—	5 m	A

Colour-change function managed using dedicated controls.

\*\* Maximum strip length with same power cable.

REEL 5 m  
Easy 5050-60 RGB / 24 Vdc

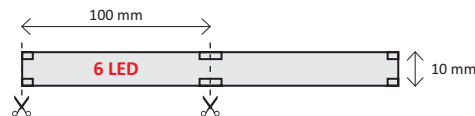

## EASY 5050-60 RGB / 24 Vdc WATERPROOF — IP 65



CODE CODICE	IP	POWER POTENZA	FLUX FLUSSO	VOLTAGE VOLTAGGIO	LEDs/m	COLOUR COLORE	CRI	MAX LENGTH** MAX LUNGHEZZA**	E.E. CLASS
WA24W5006080	IP 65	14,4 W/m	510 Lm/m	24 Vdc	60	RGB	—	5 m	A

Colour-change function managed using dedicated controls.

\*\* Maximum strip length with same power cable.

REEL 5 m  
Easy 5050-60 RGB / 24 Vdc IP65

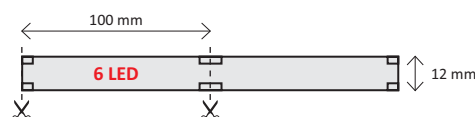

**The RGB & RGBW easy line collection is specific for those looking for a quality RGB product at an affordable price.**

Suitable for decorative lighting on shelves, coffers, in stairways and for under cabinet lighting and adjustable using the series of controls and standard power supplies listed in the specific sections. To be installed on heat sink supports suitable for power rating. Complete with 3M double-sided tape.

*La collezione RGB & RGBW easy line è dedicata a chi cerca un prodotto RGB di qualità ad un prezzo contenuto.*

*Adatta a illuminazione decorativa di mensole, sottopensili, velette, scalini e regolabile attraverso la linea di controlli e alimentatori a norma lighting proposti nelle sezioni dedicate.*

*Da installare su supporti dissipativi adeguati alla potenza espressa.*

*Completa di biadesivo 3M.*



# STRIPS ACCESSORIES

Some Castaldi strips may be sheath protected for applications requiring an IP65; check the feasibility based on the width of the printed circuit and on power strip. The metal plate ensures enough dissipation even for sheathing applications.

*Alcune strip Castaldi possono essere inguainate per applicazioni che richiedono un IP65; verificare la fattibilità in base alla larghezza del circuito stampato e in base alla potenza della strip. La lamina di metallo assicura una dissipazione sufficiente anche per applicazioni con guaina.*



**Galvanized 10 mm plate for IP65 protection.**  
*Lamina zincata 10 mm per protezione IP65.*  
**LAIQ10940V0**



**Plate X 15x2 mm with 3M double-sided tape.**  
*Lamina X 15x2 mm con biadesivo 3M.*  
**199001000015**



**Plate Y 20x2 mm with 3M double-sided tape.**  
*Lamina Y 20x2 mm con biadesivo 3M.*  
**199001000020**



**Sheath 8.**  
*Guaina 8.*  
**GUAINA08MM**



**Sheath 10.**  
*Guaina 10.*  
**GUAINA10MM**



**External magnet kit + screw + anchor.**  
*Kit calamita esterna + vite + tassello.*  
**ST0046K**



**Silicon clip kit for 10x4,5 mm waterproof sheath.**  
*Kit graffetta silicone waterproof 10x4,5 mm.*  
**ST0047K**



**Silicon clip kit for 12x4,5 mm waterproof sheath.**  
*Kit graffetta silicone waterproof 12x4,5 mm.*  
**ST0048K**



**Internal magnet kit/m (5 pcs.).**  
*Kit calamita interna/m (5 pezzi).*

**ST0053K**



**Stainless steel clip kit for 10x4,5 mm waterproof sheath.**  
*Kit graffetta inox guaina waterproof 10x4,5 mm.*

**ST0051K**



**Stainless steel clip kit for 12x4,5 mm waterproof sheath.**  
*Kit graffetta inox guaina waterproof 12x4,5 mm.*

**ST0052K**



**Kit graffetta di montaggio (5 pcs.).**  
*Kit graffetta fissaggio (5 pz.).*

**ST0055K**

# MOUNTING GUIDE

## GUIDA AL FISSAGGIO

### MOUNTING 1

1. Strip. / Strip.
2. Insulation. / Isolante.
3. Plate kit w/double-sided tape.  
*Kit lamina esterna biadesivo.*

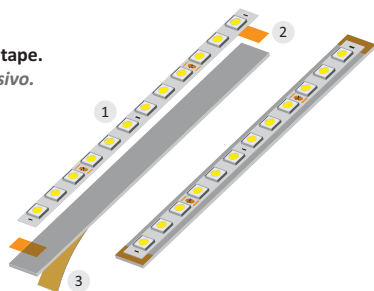

### MOUNTING 2

1. Strip. / Strip.
2. Insulation. / Isolante.
3. Sheath. / Guaina.
4. External magnet kit.  
*Kit calamita esterna.*
5. ZN Plate. / Lamina ZN.

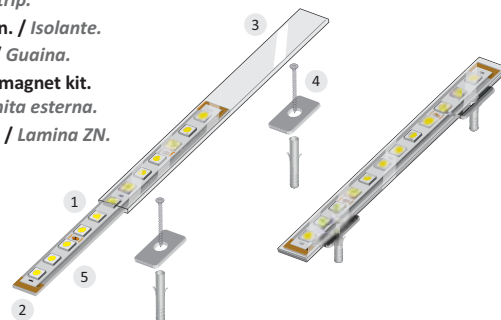

### MOUNTING 3

1. Strip. / Strip.
2. Insulation. / Isolante.
3. Sheath. / Guaina.
4. Internal magnet.  
*Calamita interna.*
5. ZN Plate. / Lamina ZN.

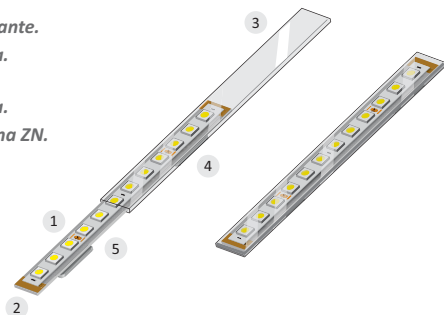

### MOUNTING 4

1. Strip. / Strip.
2. Insulation. / Isolante.
3. Sheath. / Guaina.
4. Silicon clip kit.  
*Kit graffetta silicone.*
5. ZN Plate. / Lamina ZN.

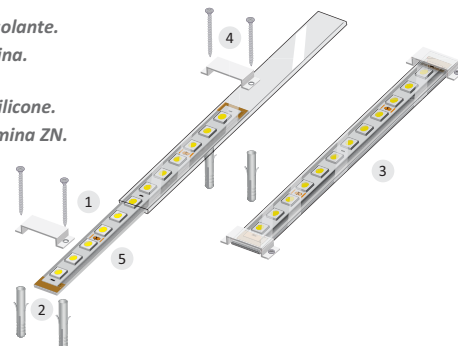

### MOUNTING 5

1. Strip. / Strip.
2. Insulation. / Isolante.
3. Sheath. / Guaina.
4. Stainless steel clip kit.  
*Kit graffetta inox.*
5. ZN Plate. / Lamina ZN.

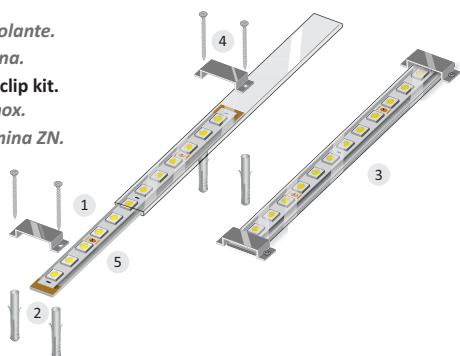

# POWER SUPPLIES AND CONTROLS

IP20 POWER SUPPLIES	p. 328
IP67 POWER SUPPLIES	p. 330
PROFESSIONAL LINE CONTROLS	p. 332
EASY LINE CONTROLS	p. 336



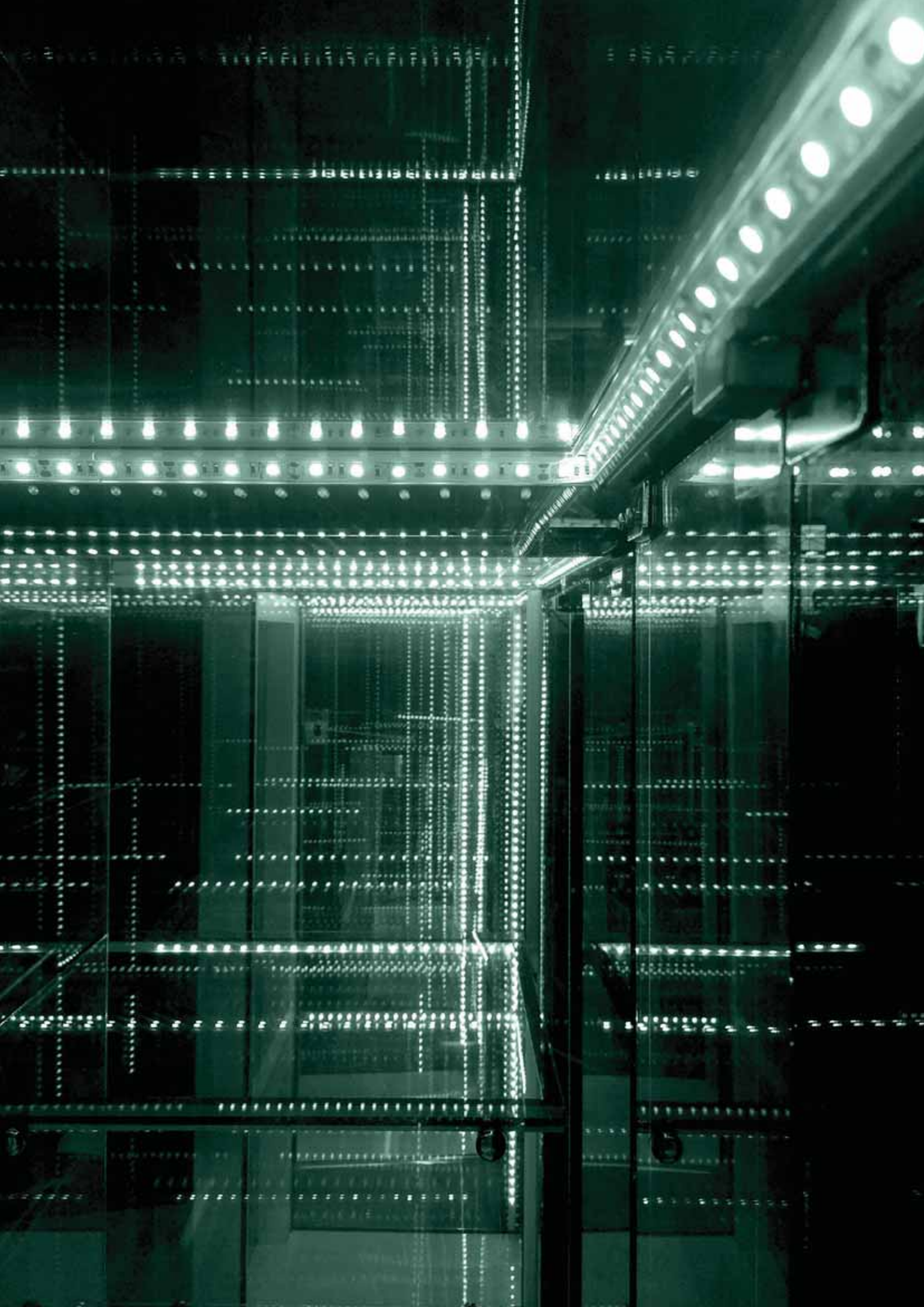



# IP20 POWER SUPPLIES

## IP 20 / ON-OFF — 18 W

CODE CODICE	IP	POWER POTENZA	INPUT ENTRATA	OUTPUT USCITA
115200020180	IP 20	18 W	220-240 Vac	24 Vdc

## IP 20 / ON-OFF — 30 W

CODE CODICE	IP	POWER POTENZA	INPUT ENTRATA	OUTPUT USCITA
METRFSF30W24V2	IP 20	30 W	220-240 Vac	24 Vdc

## IP 20 / ON-OFF — 60 W

CODE CODICE	IP	POWER POTENZA	INPUT ENTRATA	OUTPUT USCITA
METRFSF60W24V7	IP 20	60 W	220-240 Vac	24 Vdc

## IP 20 / ON-OFF — 90 W

CODE CODICE	IP	POWER POTENZA	INPUT ENTRATA	OUTPUT USCITA
METRFSF90W24V6	IP 20	90 W	220-240 Vac	24 Vdc

## IP 20 / ON-OFF — 120 W

CODE CODICE	IP	POWER POTENZA	INPUT ENTRATA	OUTPUT USCITA
METRHH120W24V	IP 20	120 W	220-240 Vac	24 Vdc

## IP 20 / LOW PROFILE — 20 W

CODE CODICE	IP	POWER POTENZA	INPUT ENTRATA	OUTPUT USCITA
METRFSFSPNP20B	IP 20	20 W	220-240 Vac	24 Vdc

## IP 20 / LOW PROFILE — 30 W

CODE CODICE	IP	POWER POTENZA	INPUT ENTRATA	OUTPUT USCITA
METRFSFSPNP30B	IP 20	30 W	220-240 Vac	24 Vdc

## IP 20 / LOW PROFILE — 50 W

CODE CODICE	IP	POWER POTENZA	INPUT ENTRATA	OUTPUT USCITA
METRFSFSPNP50B	IP 20	50 W	220-240 Vac	24 Vdc

The power supply units that Castaldi proposes are in accordance with EN 61347-2-13 and perfectly meet the needs of the Castaldi strips; choose the power supplies based on the type of application, controls, and scenarios which need to be obtained.

*Gli alimentatori che Castaldi propone sono a norma EN 61347-2-13 e rispondono perfettamente alle necessità delle strip Castaldi; scegliere gli alimentatori in base al tipo di applicazione, ai controlli e agli scenari che si vogliono ottenere.*



#### IP 20 / LINE-TYPE — 30 W

CODE CODICE	IP	POWER POTENZA	INPUT ENTRATA	OUTPUT USCITA
METRSFSPNP30C	IP 20	30 W	200 - 240 Vac	24 Vdc

#### IP 20 / DALI PUSH — 35 W

CODE CODICE	IP	POWER POTENZA	INPUT ENTRATA	OUTPUT USCITA
METRTO035W24V	IP 20	35 W	220-240 Vac	24 Vdc

#### IP 20 / LINE-TYPE — 60 W

CODE CODICE	IP	POWER POTENZA	INPUT ENTRATA	OUTPUT USCITA
METRSFSPNP60C	IP 20	60 W	200 - 240 Vac	24 Vdc

#### IP 20 / DALI PUSH — 60 W

CODE CODICE	IP	POWER POTENZA	INPUT ENTRATA	OUTPUT USCITA
METRTO060W24V	IP 20	60 W	220-240 Vac	24 Vdc

#### IP 20 / DALI PUSH — 100 W

CODE CODICE	IP	POWER POTENZA	INPUT ENTRATA	OUTPUT USCITA
METRTO100W24V	IP 20	100 W	220-240 Vac	24 Vdc

#### IP 20 / DALI PUSH — 150 W

CODE CODICE	IP	POWER POTENZA	INPUT ENTRATA	OUTPUT USCITA
METRTO150W24V	IP 20	150 W	220-240 Vac	24 Vdc

# IP67 POWER SUPPLIES

## IP 67 / 1-10 V — 40 W

CODE CODICE	IP	POWER POTENZA	INPUT ENTRATA	OUTPUT USCITA
<b>METRSF40W24V3</b>	IP 67	40 W	90-250 Vac	24 Vdc
<b>METRSF40W48V1</b>	IP 67	40 W	90-250 Vac	48 Vdc

## IP 67 / 1-10 V — 60 W

CODE CODICE	IP	POWER POTENZA	INPUT ENTRATA	OUTPUT USCITA
<b>METRSF60W24V6</b>	IP 67	60 W	90-250 Vac	24 Vdc
<b>METRSF60W48V</b>	IP 67	60 W	90-250 Vac	48 Vdc

## IP 67 / 1-10 V — 75 W

CODE CODICE	IP	POWER POTENZA	INPUT ENTRATA	OUTPUT USCITA
<b>METRS075W24V0</b>	IP 67	75 W	90-250 Vac	24 Vdc
<b>METRS075W48V0</b>	IP 67	75 W	90-250 Vac	48 Vdc

For a correct 1-10V dimming, the load must be at least 80% of the power supply unit maximum power.  
Per un corretta dimmerazione di 1-10V, il carico deve essere almeno l'80% della potenza massima dell'alimentatore.

## IP 67 / 1-10 V — 100 W

CODE CODICE	IP	POWER POTENZA	INPUT ENTRATA	OUTPUT USCITA
<b>METRS100W24V4</b>	IP 67	100 W	90-250 Vac	24 Vdc
<b>METRS100W48V</b>	IP 67	100 W	90-250 Vac	48 Vdc

For a correct 1-10V dimming, the load must be at least 80% of the power supply unit maximum power.  
Per un corretta dimmerazione di 1-10V, il carico deve essere almeno l'80% della potenza massima dell'alimentatore.

## IP 67 / 1-10 V — 150 W

CODE CODICE	IP	POWER POTENZA	INPUT ENTRATA	OUTPUT USCITA
<b>METRS150W24V1</b>	IP 67	150 W	90-250 Vac	24 Vdc
<b>METRS150W48V</b>	IP 67	150 W	90-250 Vac	48 Vdc

For a correct 1-10V dimming, the load must be at least 80% of the power supply unit maximum power.  
Per un corretta dimmerazione di 1-10V, il carico deve essere almeno l'80% della potenza massima dell'alimentatore.

## IP 67 / 1-10 V — 200 W

CODE CODICE	IP	POWER POTENZA	INPUT ENTRATA	OUTPUT USCITA
<b>METRS200W24V</b>	IP 67	200 W	90-250 Vac	24 Vdc
<b>METRS200W48V</b>	IP 67	200 W	90-250 Vac	48 Vdc

For a correct 1-10V dimming, the load must be at least 80% of the power supply unit maximum power.

Per un corretta dimmerazione di 1-10V, il carico deve essere almeno l'80% della potenza massima dell'alimentatore.

## IP 67 / 1-10 V — 240 W

CODE CODICE	IP	POWER POTENZA	INPUT ENTRATA	USCITA
<b>METRS240W24V</b>	IP 67	240 W	90-250 Vac	24 Vdc
<b>METRS240W48V</b>	IP 67	240 W	90-250 Vac	48 Vdc

For a correct 1-10V dimming, the load must be at least 80% of the power supply unit maximum power.

Per un corretta dimmerazione di 1-10V, il carico deve essere almeno l'80% della potenza massima dell'alimentatore.

## IP 67 / 1-10 V — 320 W

CODE CODICE	IP	POWER POTENZA	INPUT ENTRATA	OUTPUT USCITA
<b>115542432000</b>	IP 67	320 W	90-250 Vac	24 Vdc
<b>115544832000</b>	IP 67	320 W	90-250 Vac	48 Vdc

For a correct 1-10V dimming, the load must be at least 80% of the power supply unit maximum power.

Per un corretta dimmerazione di 1-10V, il carico deve essere almeno l'80% della potenza massima dell'alimentatore.

## IP 67 / 1-10 V — 600 W

CODE CODICE	IP	POWER POTENZA	INPUT ENTRATA	OUTPUT USCITA
<b>METRSF600W24V</b>	IP 67	600 W	90-250 Vac	24 Vdc
<b>METRSF600W48V</b>	IP 67	600 W	90-250 Vac	48 Vdc

For a correct 1-10V dimming, the load must be at least 80% of the power supply unit maximum power.

Per un corretta dimmerazione di 1-10V, il carico deve essere almeno l'80% della potenza massima dell'alimentatore.

## IP 67 / DALI — 75 W

CODE CODICE	IP	POWER POTENZA	INPUT ENTRATA	OUTPUT USCITA
<b>METRS075W24D</b>	IP 67	75 W	220-240 Vac	24 Vdc
<b>METRS075W48D</b>	IP 67	75 W	220-240 Vac	48 Vdc

For a correct 1-10V dimming, the load must be at least 80% of the power supply unit maximum power.

*Per un corretta dimmerazione di 1-10V, il carico deve essere almeno l'80% della potenza massima dell'alimentatore.*

## IP 67 / DALI — 100 W

CODE CODICE	IP	POWER POTENZA	INPUT ENTRATA	OUTPUT USCITA
<b>METRS100W24D</b>	IP 67	100 W	220-240 Vac	24 Vdc
<b>METRS100W48D</b>	IP 67	100 W	220-240 Vac	48 Vdc

For a correct 1-10V dimming, the load must be at least 80% of the power supply unit maximum power.

*Per un corretta dimmerazione di 1-10V, il carico deve essere almeno l'80% della potenza massima dell'alimentatore.*

## IP 67 / DALI — 150 W

CODE CODICE	IP	POWER POTENZA	INPUT ENTRATA	OUTPUT USCITA
<b>METRS150W24D</b>	IP 67	150 W	220-240 Vac	24 Vdc
<b>METRS150W48D</b>	IP 67	150 W	220-240 Vac	48 Vdc

For a correct 1-10V dimming, the load must be at least 80% of the power supply unit maximum power.

*Per un corretta dimmerazione di 1-10V, il carico deve essere almeno l'80% della potenza massima dell'alimentatore.*

## IP 67 / DALI — 200 W

CODE CODICE	IP	POWER POTENZA	INPUT ENTRATA	OUTPUT USCITA
<b>METRS200W24D</b>	IP 67	200 W	220-240 Vac	24 Vdc
<b>METRS200W48D</b>	IP 67	200 W	220-240 Vac	48 Vdc

For a correct 1-10V dimming, the load must be at least 80% of the power supply unit maximum power.

*Per un corretta dimmerazione di 1-10V, il carico deve essere almeno l'80% della potenza massima dell'alimentatore.*

## IP 67 / DALI — 240 W

CODE CODICE	IP	POWER POTENZA	INPUT ENTRATA	OUTPUT USCITA
<b>METRS240W24D</b>	IP 67	240 W	220-240 Vac	24 Vdc
<b>METRS240W48D</b>	IP 67	240 W	220-240 Vac	48 Vdc

For a correct 1-10V dimming, the load must be at least 80% of the power supply unit maximum power.

*Per un corretta dimmerazione di 1-10V, il carico deve essere almeno l'80% della potenza massima dell'alimentatore.*





# PROFESSIONAL LINE



## RIGOLETTO RGB MASTER

CODE CODICE	IP	POWER POTENZA	APPLICATION APPLICAZIONE	VOLTAGE VOLTAGGIO	INPUT ENTRATA	OUTPUT USCITA
114100050013	IP 20	108-216 W	3CH (RGB)	12-48 Vdc	MASTER - PUSH, IR*	3 x 3 A DMX

\* Optional.

Control for professional use, manages RGB LED strips with 12 to 24 Vdc power supply. Can be managed by button or IR remote control (ordered separately). The multifunction inputs (push, IR) and power and DMX outputs make the control highly versatile, allowing it to be used in the majority of projects. The control can manage high power systems using the twinned Rigoletto SLAVE devices, driving several modules via the DMX output. 12-24 Vdc power supply, max corresponding power (auto-limiting) 3 x 36-72 W (108-216 W tot.).

Controllo per uso professionale, permette di regolare strip led RGB con alimentazione da 12 a 24Vdc. Gestibile con pulsante o telecomando IR (da ordinare a parte). Gli ingressi multifunzione (push, IR) e le uscite di potenza e DMX, lo rendono altamente versatile ed applicabile alla maggior parte dei progetti. Permette di gestire impianti di potenza elevata, attraverso l'apparecchiatura gemella Rigoletto SLAVE, di cui può gestire numerosi moduli attraverso l'uscita DMX. Alimentazione 12-24 Vdc, potenza max rispettiva (autolimitata) 3 x 36-72 W (108-216 W tot.).



## RIGOLETTO RGB SLAVE

CODE CODICE	IP	POWER POTENZA	APPLICATION APPLICAZIONE	VOLTAGE VOLTAGGIO	INPUT ENTRATA	OUTPUT USCITA
114100050023	IP 20	160 W max/96 W* 320 W max/200 W* 480 W max/240 W*	3CH (RGB, WWW)	12-24-48 Vdc	SLAVE - DMX	3 x 4 A

\* Maximum for channel. Massimo per canale.

The RIGOLETTO SLAVE DMX interface is a DMX slave with 3 output channels. Each channel is associated with a DMX address. The 3 addresses are consecutive (e.g. if channel 1 is associated with address 27, channel 2 will be associated with address 28 and channel 3 with address 29). The outputs are implemented by PWM driver. By closing the FLK input grounded to earth, the free flicker mode is activated which may need to be selected when driving channels with fixing magnets. The slave address is selected by the dip switch with 1-9 lever. The encoding is binary. The dip switch 1 has weight 1, dip switch 2 has weight 2, and dip 3 has weight 4. The addresses range from 1 to 512. In the left column some examples of configuration: in the first case being selected only dip 3 the address goes to value 4; in the second case by selecting 1, 2, 4 the address goes to value 11; while in the third and last case with 4, 6, 7 goes to value 104. With the dip switch 10 (MODE) in the ON position the 8-bit standard mode is selected while in the OFF position the 16 bit City Design mode is selected. The 16-bit mode is compatible only with products by City Design. To download the full list of addresses, visit the Penta Architectural website.

L'interfaccia RIGOLETTO SLAVE DMX è uno slave DMX con 3 canali di uscita. Ogni canale è associato ad un indirizzo DMX. I 3 indirizzi sono consecutivi (se il canale 1 è associato per esempio all'indirizzo 27, il canale 2 sarà associato all'indirizzo 28 e il canale 3 all'indirizzo 29). Le uscite vengono attuate tramite pilotaggio PWM. Chiudendo a massa l'ingresso FLK viene attivata la modalità flicker free che può essere necessario selezionare in caso di pilotaggio di profili con magneti di fissaggio. L'indirizzo dello slave viene selezionato tramite i dip switch a levetta 1-9. La codifica è binaria. Il dip switch 1 ha peso 1, il dip switch 2 ha peso 2, il dip 3 ha peso 4. Gli indirizzi variano da 1 a 512. Nella colonna a sinistra alcuni esempi di configurazione: nel primo caso essendo selezionato solo il dip 3 l'indirizzo assume il valore 4; nel secondo caso selezionando 1, 2, 4 l'indirizzo ha valore 11; mentre nel terzo e ultimo caso con 4, 6, 7 ha valore 104. Con il dip switch 10 (MODE) in posizione ON si seleziona la modalità 8 bit standard mentre in posizione OFF si seleziona la modalità 16 bit City Design. La modalità 16 bit è compatibile solo con prodotti by City Design. Per scaricare la lista completa degli indirizzi visitare il sito di Penta Architectural.

The controls that Castaldi proposes are in accordance with EN 61347-2-13 and meet all installation and scenario requirements.

*I controlli che Castaldi propone sono a norma EN 61347-2-13 e rispondono a tutte le esigenze di installazione e di scenario.*



### REMOTE CONTROL WITH IR SENSOR (FOR RIGOLETTO RGB) TELECOMANDO CON SENSORE IR (PER RIGOLETTO RGB)

CODE CODICE	APPLICATION APPLICAZIONE	VOLTAGE VOLTAGGIO	INPUT ENTRATA	OUTPUT USCITA
ST0919	Remote control kit with sensor	Battery	Buttons	IR
114200010000	Remote control (spare)	Battery	Buttons	IR



### RIGOLETTO WHITE 3CH MASTER

CODE CODICE	IP	POWER POTENZA	APPLICATION APPLICAZIONE	VOLTAGE VOLTAGGIO	INPUT ENTRATA	OUTPUT USCITA
114100050015	IP 20	96-216-432 W	3CH (WWW)	12-24-48 Vdc	MASTER - PUSH, IR*	3 x 3 A

\* Optional.

Control for professional use, manages monochrome LED strips with 12 to 48 Vdc power supply. Can be managed by button or IR remote control (ordered separately). The multifunction inputs (push, IR) and power and DMX outputs make the control highly versatile, allowing it to be used in the majority of projects. The control can manage high power systems using the twinned Rigoletto SLAVE devices, driving several modules via the DMX output. 12-24-48 Vdc power supply, max power (auto-limiting) 108-216 W, distributed as needed via the 3 output profiles.

*Controllo per uso professionale, permette di regolare strip LED Monocromatiche con alimentazione da 12 a 48 Vdc. Gestibile con pulsante o telecomando IR (da ordinare a parte). Gli ingressi multifunzione (push, IR) e le uscite di potenza e DMX, lo rendono altamente versatile ed applicabile alla maggior parte dei progetti. Permette di gestire impianti di potenza elevata, attraverso l'apparecchiatura gemella Rigoletto SLAVE, da cui può gestire numerosi moduli attraverso l'uscita DMX. Alimentazione 12-24-48 Vdc, potenza max (autolimitata) 108-216 W, distribuibile secondo le necessità sui 3 canali d'uscita.*



### REMOTE CONTROL WITH IR SENSOR (FOR RIGOLETTO WHITE) TELECOMANDO CON SENSORE IR (PER RIGOLETTO WHITE)

CODE CODICE	APPLICATION APPLICAZIONE	VOLTAGE VOLTAGGIO	INPUT ENTRATA	OUTPUT USCITA
ST0946	Remote control kit with sensor	Battery	Buttons	IR
ST093710G	Remote control (spare)	Battery	Buttons	IR



## RIGOLETTO 4 IN 1 FLICKER FREE MULTI INPUT DIMMER - AMPLIFIER RIGOLETTO 4 IN 1 DIMMER MULTI INGRESSO - AMPLIFICATORE

CODE CODICE	IP	POWER POTENZA	APPLICATION APPLICAZIONE	VOLTAGE VOLTAGGIO	INPUT ENTRATA	OUTPUT USCITA
114100050009	IP 20	120-240-480 W	White	12-24-48 Vdc	PUSH, 0-10V, 100kΩ pot., PWM	10 A

Interface for professional use to control strip brightness. A highly versatile instrument, can operate from 12 Vdc to 48 Vdc and is controlled by button, 0-10 Vdc analogue input, 100 kΩ potentiometer or PWM signal. The latter input type allows the device to be also used as a signal amplifier.

Dedicated electronics mean long input signal cables can be used without affecting correct product operation.

Power supply 12-24-48 Vdc, max power with automatic limiting 120-240-480 W. Using appropriate settings this interface also functions in Flicker Free mode, it is necessary with the use of channels with magnetic holder, to eliminate possible hums in the system.

*Interfaccia per uso professionale per il controllo dell'intensità luminosa delle strip. Strumento altamente versatile, accetta alimentazioni da 12 Vdc a 48 Vdc ed è controllabile con pulsante, ingresso analogico 0-10 V, potenziometro da 100 kΩ, segnale pwm. Quest'ultima specifica dell'ingresso, ne consente l'utilizzo anche come amplificatore di segnale. L'adozione di elettronica dedicata, permette di utilizzare cavi di ingresso segnale di lunghezza elevata, senza compromettere il buon funzionamento del prodotto. Alimentazione 12-24-48 Vdc, potenza max autolimitata 120-240-480 W. Mediante opportuno settaggio questa interfaccia opera anche in modalità Flicker Free, necessaria con l'utilizzo di profili a fissaggio magnetico, per eliminare possibili ronzii del sistema.*



## NORMA PUSH 2CH

CODE CODICE	IP	POWER POTENZA	APPLICATION APPLICAZIONE	VOLTAGE VOLTAGGIO	INPUT ENTRATA	OUTPUT USCITA
114100050016	IP 20	160 W max/96 W* 320 W max/200 W* 480 W max/240 W*	White Dimming, Dynamic White	12-24-48 Vdc	PUSH, 1-10, 100kΩ pot., PVM, DMX	13 A max

\* Maximum for channel. Massimo per canale.

The interface NORMA PUSH may function in 4 different modes: 2 channel white mode, single channel mode, dynamic white mode, single channel 1-10V mode. In single-channel mode with any configuration, the maximum power is 480W to 48V and 320W to 24V. When turning on, the load applied to the 2 channels is checked, if the load exceeds the maximum allowed, the red led (right to the 10-pin connector) flashes quickly and the interface is blocked, and if the applied load is at the permitted level, the red LED remains turned off. The commands may come from keys and/or remote control indifferently (for the IR remote control, order the kit code ST0946 which includes the remote control and IR receiver). The interface Norma Push accepts at Terminal 1-10, signals which are compatible with levels of type 1-10V (0-10V), home automation interfaces (0-10V) or 100kΩ potentiometer. By inserting the appropriate expansion cards, it is possible to implement a second 1-10V channel (Module 1-10 Plus, Code ST0954). Using appropriate settings this interface also functions in Flicker Free mode, it is necessary with the use of channels with magnetic holder, to eliminate possible hums in the system.

*L'interfaccia NORMA PUSH può funzionare in 4 diverse modalità: modalità bianco 2 canali, modalità mono canale, modalità bianco dinamico, modalità 1-10V monocanale. Nella modalità monocanale con qualsiasi configurazione, la potenza massima è di 480W a 48V e 320W a 24V. All'accensione viene verificato il carico applicato ai 2 canali, se il carico supera il massimo consentito il led rosso (presente a destra del connettore 10 poli) lampeggia velocemente e l'interfaccia si blocca, mentre se il carico applicato è congruo al livello consentito, il led rosso rimane spento. I comandi possono provenire da tasti e/o da telecomando in modo indifferente (per il telecomando IR ordinare il Kit codice ST0946 che comprende telecomando e ricevitore IR). L'interfaccia norma push accetta al morsetto 1-10, segnali compatibili con livelli di tipo 1-10V (0-10V), interfacce domotiche (0-10V), oppure potenziometro da 100kΩ. Tramite l'inserimento delle opportune schede di espansione, è possibile implementare un secondo canale 1-10V (Modulo 1-10 Plus, Cod ST0954). Mediante opportuno settaggio questa interfaccia opera anche in modalità Flicker Free, necessaria con l'utilizzo di profili a fissaggio magnetico, per eliminare possibili ronzii del sistema.*

## ST0936 MODULE DMX

CODE  
CODICE

ST0936

Module to be installed inside the Norma.

The Norma without this module has no data connection while with DMX module it turns into MASTER/SLAVE after configuration.

*Modulo da installare all'interno della Norma.*

*La norma di default non ha connessione dati, con modulo DMX si trasforma in MASTER/SLAVE tramite opportune configurazioni esterne.*



## ST0954 MODULE 1-10V PLUS

CODE  
CODICE

ST0954

Module to be installed inside the Norma.  
The Norma has only one 1-10V entrance and thus the 2 channels can be dimmed simultaneously. With the 1-10 module the 2 channels can be controlled separately.

*Modulo da installare all'interno della norma. La norma ha solo un ingresso 1-10V e di conseguenza i due canali vengono dimmerati in contemporanea, con il modulo 1-10V si aggiunge la possibilità di controllare separatamente i due canali.*



### REMOTE CONTROL WITH IR SENSOR TELECOMANDO CON SENSORE IR

CODE  
CODICE

APPLICATION  
APPLICAZIONE

VOLTAGE  
VOLTAGGIO

INPUT  
ENTRATA

OUTPUT  
USCITA

ST0946

Remote Control Kit with Sensor

Battery

Buttons

IR



### REMOTE CONTROL TELECOMANDO

CODE  
CODICE

APPLICATION  
APPLICAZIONE

VOLTAGE  
VOLTAGGIO

INPUT  
ENTRATA

OUTPUT  
USCITA

ST093710G

Remote Control Kit with Sensor

Battery

Buttons

IR



### DALI INTERFACE INTERFACCIA DALI

CODE  
CODICE

POWER  
POTENZA

APPLICATION  
APPLICAZIONE

VOLTAGE  
VOLTAGGIO

INPUT  
ENTRATA

OUTPUT  
USCITA

114110090122

144-288 W

1 CH

12-24 Vdc

DALI SIGNAL, 1-10V, PUSH

12 A

Multifunction interface with 1-10 Vdc input, Dali, Push.

*Interfaccia multifunzione con ingresso 1-10Vdc, Dali, Push.*

# EASY LINE



## REMOTE PIR SENSOR SENSORE PIR REMOTO

CODE CODICE	IP	POWER POTENZA	APPLICATION APPLICAZIONE	VOLTAGE VOLTAGGIO	INPUT ENTRATA	OUTPUT USCITA
114300010052	—	72 W	—	12-24 Vdc	—	3 A Max



## EMERGENCY KIT KIT DI EMERGENZA

CODE CODICE	IP	POWER POTENZA	APPLICATION APPLICAZIONE	VOLTAGE VOLTAGGIO	INPUT ENTRATA	OUTPUT USCITA
115900030000	IP 20	24-30 W	Power failure <i>Interruzione di corrente</i>	12-24 Vdc	220-240 V	12-24 V

Emergency system for LED strips, comprising control unit and battery pack, 12-24 V input (power) and mains voltage (control).

*Sistema di emergenza per strip composto da centrale di regolazione e pacco accumulatori, ingresso 12-24 V (potenza) e tensione di rete (controllo).*



## EASY DIMMER TOUCH + RF REMOTE CONTROL EASY DIMMER TOUCH + TELECOMANDO RF

CODE CODICE	IP	POWER POTENZA	APPLICATION APPLICAZIONE	VOLTAGE VOLTAGGIO	INPUT ENTRATA	OUTPUT USCITA
ST0959	IP 20	96-192 W	White	12-24 Vdc	Wireless Control RF	1 x 8 A



## EASY WHITE DYNAMIC CONTROLLER + RF REMOTE CONTROL EASY WHITE DYNAMIC CONTROLLER + TELECOMANDO RF

CODE CODICE	IP	POWER POTENZA	APPLICATION APPLICAZIONE	VOLTAGE VOLTAGGIO	INPUT ENTRATA	OUTPUT USCITA
ST0960K	IP 20	96-192 W	Dynamic White	12-24 Vdc	Wireless Control RF	2 x 4 A



## EASY RGB CONTROLLER KIT + RF REMOTE CONTROL EASY KIT RGB CONTROLLER + TELECOMANDO RF

CODE CODICE	IP	POWER POTENZA	APPLICATION APPLICAZIONE	VOLTAGE VOLTAGGIO	INPUT ENTRATA	OUTPUT USCITA
ST0961	IP 20	108-216 W	RGB	12-24 Vdc	Wireless Control RF	3 x 3 A



## POTENTIOMETER & KNOB POTENZIOMETRO & MANOPOLA

CODE CODICE	RESISTANCE RESISTENZA	APPLICATION APPLICAZIONE
MEPOTMAND6	—	KNOB
MEPOT050KOHM	50 KOHM	POTENTIOMETER
MEPOT100KOHM	100 KOHM	POTENTIOMETER



### EASY KIT RGBW CONTROLLER WITH RF REMOTE *KIT EASY RGBW CONTROLLER CON TELECOMANDO RF*

CODE CODICE	IP	POWER POTENZA	APPLICATION APPLICAZIONE	VOLTAGE VOLTAGGIO	INPUT ENTRATA	OUTPUT USCITA
ST0951	IP 20	240-480 W	RGBW	12-24 Vdc	Wireless Control RF	4 x 5 A



### TOUCH PANEL RGBW DMX MASTER

CODE CODICE	IP	POWER POTENZA	APPLICATION APPLICAZIONE	VOLTAGE VOLTAGGIO	INPUT ENTRATA	OUTPUT USCITA
ST0938	IP 20	—	RGBW	12-24 Vdc	PUSH CONTROL	DMX SIGNAL



### DECODER SLAVE RGBW DMX

CODE CODICE	IP	POWER POTENZA	APPLICATION APPLICAZIONE	VOLTAGE VOLTAGGIO	INPUT ENTRATA	OUTPUT USCITA
ST0939	IP 20	240-480 W	RGBW	12-24 Vdc	MASTER PUSH CONTROL	4 x 5 A



### RGB WHITE CONTROLLER

CODE CODICE	IP	POWER POTENZA	APPLICATION APPLICAZIONE	VOLTAGE VOLTAGGIO	INPUT ENTRATA	OUTPUT USCITA
ME-1009FA	IP 20	120-240 W	RGBW	12-24 Vdc	Wireless Remote RF	4 x 2,5 A



### RGBW REMOTE CONTROL *TELECOMANDO RGBW*

CODE CODICE	IP	POWER POTENZA	APPLICATION APPLICAZIONE	VOLTAGE VOLTAGGIO	INPUT ENTRATA	OUTPUT USCITA
ME-2819Sp	—	Battery	Remote Control	—	BUTTONS	RF



### REPETER PWM *AMPLIFICATORE PWM*

CODE CODICE	IP	POWER POTENZA	APPLICATION APPLICAZIONE	VOLTAGE VOLTAGGIO	INPUT ENTRATA	OUTPUT USCITA
ST0949	IP 20	240-480 W	RGBW	12-24 Vdc	PWM SIGNAL	4 x 5 A



### DIMMER 4CH DALI

CODE CODICE	IP	POWER POTENZA	APPLICATION APPLICAZIONE	VOLTAGE VOLTAGGIO	INPUT ENTRATA	OUTPUT USCITA
ST0944	IP 20	240-480 W	4CH	12-24 Vdc	DALI SIGNAL	4 x 5 A

# PRODUCT CONFIGURATOR

CABLE OUTLET GUIDE p. 340

KEY TABLE p. 343

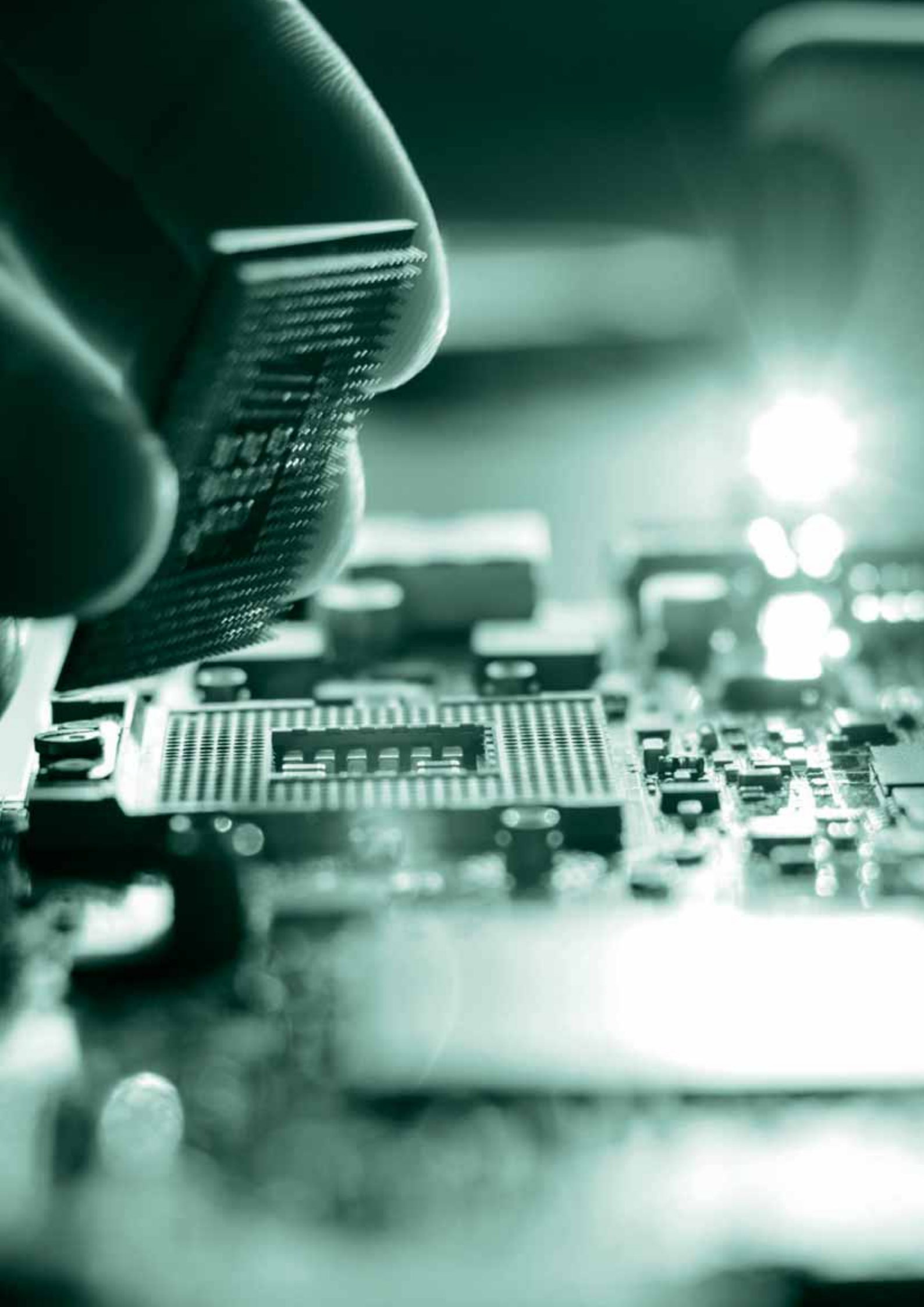

# CABLE OUTLET GUIDE

## GUIDA USCITE CAVO

### RECTANGULAR PROFILE PROFILO RETTANGOLARE

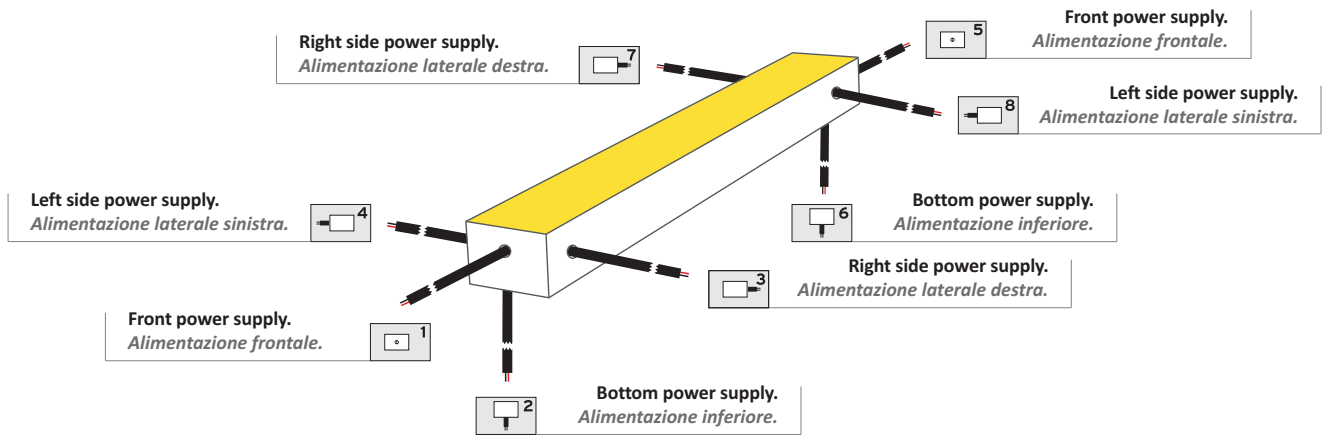

**SPECIFY THE CABLE OUTLET REFERENCE NUMBERS WHEN PLACING THE ORDER.**  
**AL MOMENTO DELL'ORDINE SI PREGA DI INDICARE I NUMERI DI RIFERIMENTO DELLE USCITE CAVO.**

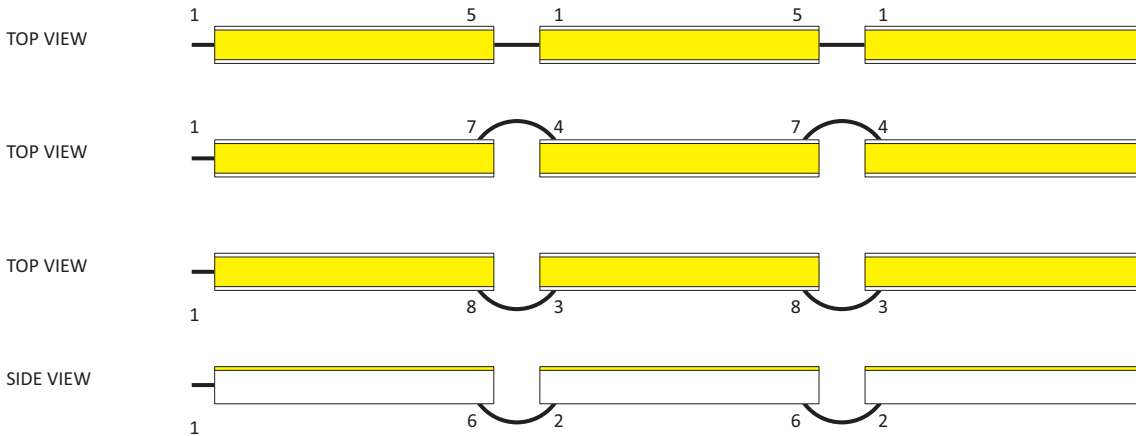

**TRIANGULAIRE PROFILE**  
*PROFILO TRIANGOLARE*

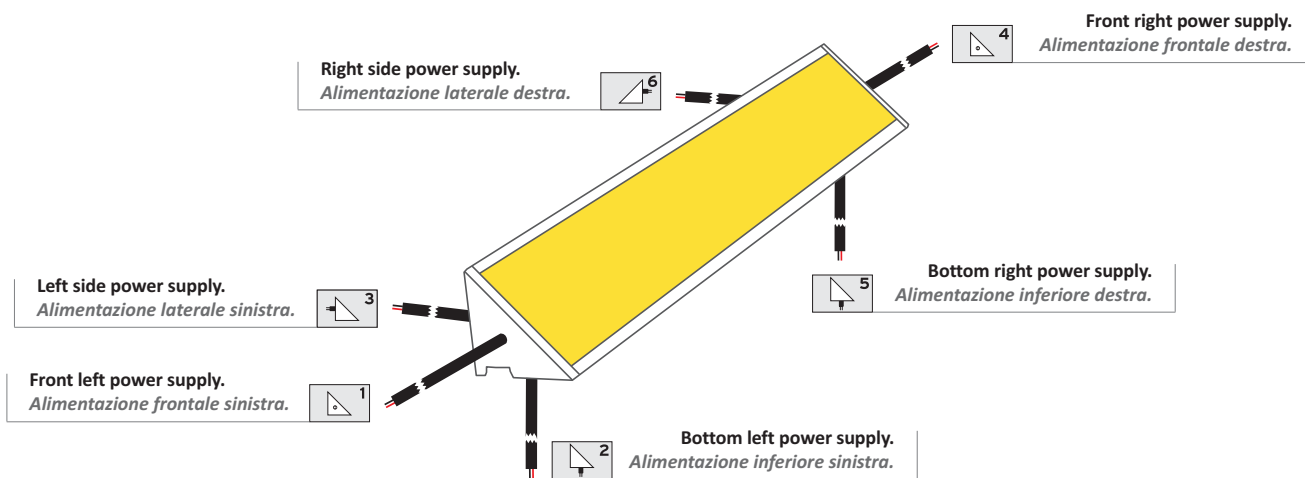

**SPECIFY THE CABLE OUTLET REFERENCE NUMBERS WHEN PLACING THE ORDER.**  
*AL MOMENTO DELL'ORDINE SI PREGA DI INDICARE I NUMERI DI RIFERIMENTO DELLE USCITE CAVO.*

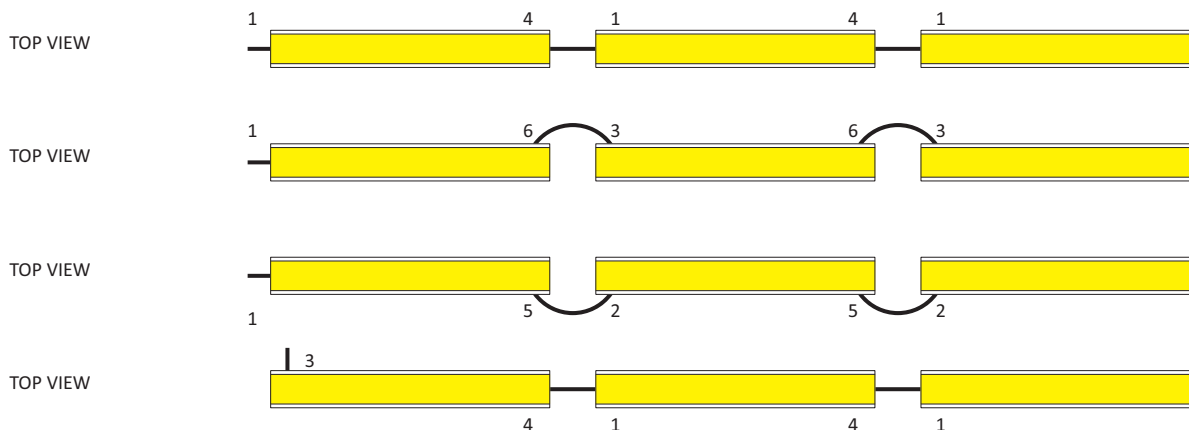











# KEY TABLE











## PROFILE INSTALLATION PROFILO D'INSTALLAZIONE

	<b>Suspended.</b> <i>A Sospensione.</i>
	<b>Ceiling.</b> <i>A plafone.</i>
	<b>Recessed.</b> <i>A incasso.</i>
	<b>Wall application.</b> <i>A parete.</i>









## PROFILE RESINABLE PROFILO RESINABILE

	<b>Only resin.</b> <i>Resinabile solo senza copertura.</i>
	<b>Resin and cover.</b> <i>Resinabile con copertura.</i>







## SYMBOLS SIMBOLI

	<b>The LED emission spectrum is within the field of visible light and therefore UV and IR values are very low.</b> <i>I LED hanno uno spettro di emissione nel campo della luce visibile per cui contengono bassissimi valori di UV e IR.</i>
	<b>The LED STRIP must be in contact with a heat sink to reject the excess temperature.</b> <i>La STRIP LED deve essere a contatto con un dissipatore per smaltire la temperatura in eccesso.</i>
	<b>Adjustable intensity using the dedicated series of controls.</b> <i>Intensità regolabile attraverso le linee di controlli dedicate.</i>
	<b>Individual power supply for long sections of STRIP.</b> <i>Singola alimentazione per lunghi tratti di STRIP.</i>
	<b>High uniformity of light emission.</b> <i>Alta uniformità di emissione di luce.</i>
	<b>Extremely narrow STRIPS, the only ones of their kind.</b> <i>STRIP strettissime uniche nel loro genere.</i>
	<b>Very narrow STRIPS.</b> <i>STRIP molto strette.</i>
	<b>Highly modular STRIPS. Each LED is powered individually.</b> <i>STRIP ad altissima modularità. Ogni LED viene alimentato singolarmente.</i>
	<b>High colour rendering index at 2800-3000K.</b> <i>Alta resa cromatica a 2800-3000K.</i>
	<b>High colour rendering index at 4000-4250K.</b> <i>Alta resa cromatica a 4000-4250K.</i>
	<b>High colour rendering index at 6000-6500K.</b> <i>Alta resa cromatica a 6000-6500K.</i>

## CABLE OUTLET GUIDE GUIDA USCITA CAVO

RECTANGULAR PROFILE / PROFILO RETTANGOLARE		<b>1</b> Front power supply. <i>Alimentazione frontale.</i>
		<b>2</b> Bottom power supply. <i>Alimentazione inferiore.</i>
		<b>3</b> Right side power supply. <i>Alimentazione laterale destra.</i>
		<b>4</b> Left side power supply. <i>Alimentazione laterale sinistra.</i>
		<b>5</b> Front power supply. <i>Alimentazione frontale.</i>
		<b>6</b> Bottom power supply. <i>Alimentazione inferiore.</i>
		<b>7</b> Right side power supply. <i>Alimentazione laterale destra.</i>
		<b>8</b> Left side power supply. <i>Alimentazione laterale sinistra.</i>

## CABLE OUTLET GUIDE GUIDA USCITA CAVO

CORNER PROFILE / PROFILO TRIANGOLARE		<b>1</b> Front left power supply. <i>Alimentazione frontale sinistra.</i>
		<b>2</b> Bottom left power supply. <i>Alimentazione inferiore sinistra.</i>
		<b>3</b> Left side power supply. <i>Alimentazione laterale sinistra.</i>
		<b>4</b> Front right power supply. <i>Alimentazione frontale destra.</i>
		<b>5</b> Bottom right power supply. <i>Alimentazione inferiore destra.</i>
		<b>6</b> Right side power supply. <i>Alimentazione laterale destra.</i>

	<b>IP 00</b> No type of protection. <i>Nessun tipo di protezione.</i>
	<b>IP 20</b> Protection against solid objects greater than 12 mm in size. <i>Protetto contro i corpi solidi maggiori di 12 mm.</i>
	<b>IP 65</b> Total protection against penetration of solid objects and dust. Protection against penetration of liquids from dripping water, mist, spraying water and jets of water in any direction. <i>Protezione totale alla penetrazione di corpi solidi e polveri. Protezione contro la penetrazione di liquidi da gocce vapori, spruzzi e getti d'acqua in qualsiasi direzione.</i>
	<b>CE</b> Conformity to the safety requirements of one or more European Directives. <i>Conformità ai requisiti di sicurezza previsti da una o più Direttive Comunitarie.</i>
	<b>RoHS Compliant</b> Restrictions on the use of certain hazardous substances in the production of electronic equipment. <i>Restrizioni sull'uso di determinate sostanze pericolose nella produzione di apparecchiature elettroniche.</i>
	<b>Protection class III.</b> Device protected against electric shock based on the use of safety extra-low voltage (SELV). The maximum voltage generated in such devices is 48V. <i>Classe di protezione III. Dispositivo nel quale la protezione contro le scosse elettriche si basa sull'utilizzo di tensione di sicurezza extra bassa (SELV). In tale dispositivo non si produce una tensione superiore a 48V.</i>
	<b>Colour can be managed using the dedicated series of controls.</b> <i>Colore gestibile attraverso le linee di controlli dedicate.</i>

# PHOTO CREDITS

Jürg Knuchel

Emanuele Bertani

Stefano Anzini

©Luc Boegly

©Luis Hevia

Espacio Aretha

Lichtkompetenz GmbH

© Castaldi

**All rights reserved.**

The specifications and technical data provided in this catalogue are intended as a guide only.

Castaldi reserves the right to make changes without notice.

For further information, please visit [www.castaldilighting.it](http://www.castaldilighting.it).

© Castaldi

**Tutti i diritti riservati.**

*Le caratteristiche e i dati tecnici riportati nel presente catalogo sono forniti solo a titolo indicativo.*

*Castaldi si riserva il diritto di apportare variazioni senza previa notifica.*

*Per ulteriori informazioni, visita [www.castaldilighting.it](http://www.castaldilighting.it).*



**Castaldi is part of PENTA Group**  
Via Benvenuto Cellini 8  
21012 Cassano Magnago (VA) Italy  
T +39.0331.706.91  
F +39.0331.706.999  
info@castaldilighting.it  
www.castaldilighting.it