



SPARTA

STAINLESS STEEL

**SLEEK AND CONTEMPORARY WITH
SUPERIOR STRENGTH AND PERFORMANCE**

The Sparta Collection features an array of ultra-modern indicator and accent lighting in heavy duty cast 316 stainless steel. These expertly engineered fixtures ensure flexibility in a variety of environments.

HINKLEY



EXPAND YOUR HORIZONS



Explore Sparta's sleek, contemporary collection and imagine the possibilities.

The ultra-modern Sparta series is constructed from solid stainless steel alloy for virtually indestructible lighting. Four robust designs are expertly engineered to deliver water-tight fixtures that ensure flexibility for a variety of applications.

For more details on the newest addition to Hinkley's luxury landscape lighting portfolio, visit hinkley.com/sparta.

EASY TO SET UP AND ENJOY

Simply pair Sparta fixtures with a Hinkley low-voltage transformer and voila! Hinkley transformers feature 12V and 15V multi-tap outputs for superior strength and performance.

SPARTA SNAPSHOT

Construction: 316 Stainless Steel | **Power:** 12V | **Color Temperature:** 3000K

Suitable For: Use in wet (outdoor direct rain or sprinkler) locations as defined by NEC and CEC. Meets United States UL Underwriters Laboratories & CSA Canadian Standards Association Product Safety Standards. Integrated LED components carry a 10-year limited warranty. Please refer to Hinkley's Warranty for complete product warranty details as some warranty limitations may apply.

Transformer required

DOT BUTTON LIGHTS

Dot indicator lighting is a recessed integrated LED inground landscape luminaire featuring durable clear optic glass and constructed with cast 316 stainless steel.

Available in both small and large sizes and round and square contemporary forms for up, down and side light applications, Dot ensures maximum flexibility. A burial sleeve is included.



INTEGRATED LED

Each energy-efficient fixture is equipped with a fully integrated LED panel and built-in driver.



DIMMABLE

Item is dimmable.

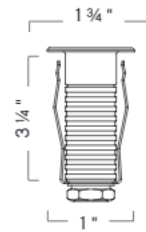

15074 SS
DOT LED SMALL
ROUND BUTTON LIGHT
1 3/4" DIA., 3/4" D

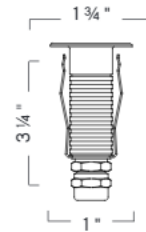
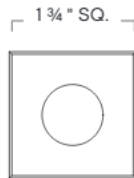

15084 SS
DOT LED SMALL
SQUARE BUTTON LIGHT
1 3/4" SQ., 3/4" D



LED ITEM	MAX WATTAGE / VOLT AMPS	LUMENS	COLOR TEMP.	HALOGEN EQUIV.	LIFESPAN	FINISH	CONSTRUCTION	LENS
15074 SS	2.5w / 3VA	50	3000K	10w	40,000 hrs	Stainless Steel	Stainless Steel	Clear Optic
15084 SS	2.5w / 3VA	50	3000K	10w	40,000 hrs	Stainless Steel	Stainless Steel	Clear Optic

Suitable for use in wet (outdoor direct rain or sprinkler) locations as defined by NEC and CEC. Constructed with 316 stainless steel. Rated for both indoor and outdoor use. IP67 outdoor rated. LED integrated components carry a 10-year limited warranty. Burial sleeve included.



15074 SS
SHOWN WITH INCLUDED BURIAL SLEEVE

PHOTOMETRIC GUIDE

15074 SS

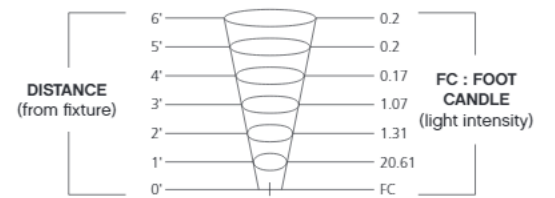

15084 SS
SHOWN WITH INCLUDED BURIAL SLEEVE

PHOTOMETRIC GUIDE

15084 SS

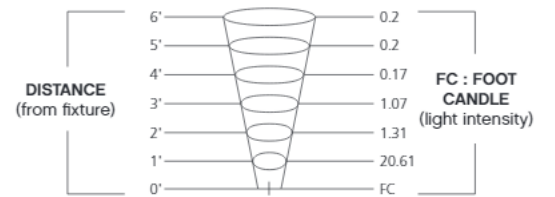

DOT BUTTON LIGHTS

Dot indicator lighting is a recessed integrated LED inground landscape luminaire featuring durable clear optic glass and constructed with cast 316 stainless steel.

Available in both small and large sizes and round and square contemporary forms for up, down and side light applications, Dot ensures maximum flexibility. A burial sleeve is included.



INTEGRATED LED

Each energy-efficient fixture is equipped with a fully integrated LED panel and built-in driver.



DIMMABLE

Item is dimmable.

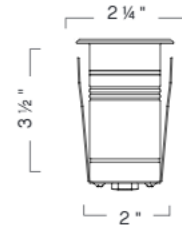

15075 SS
DOT LED LARGE
ROUND BUTTON LIGHT
2 1/4" DIA., 3 1/2" D

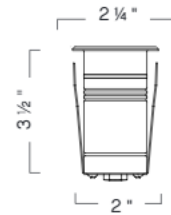

15085 SS
DOT LED LARGE
SQUARE BUTTON LIGHT
2 1/4" SQ., 3 1/2" D



LED ITEM	MAX WATTAGE / VOLT AMPS	LUMENS	COLOR TEMP.	HALOGEN EQUIV.	LIFESPAN	FINISH	CONSTRUCTION	LENS
15075 SS	4w / 4.8VA	150	3000K	25w	40,000 hrs	Stainless Steel	Stainless Steel	Clear Optic
15085 SS	4w / 4.8VA	150	3000K	25w	40,000 hrs	Stainless Steel	Stainless Steel	Clear Optic

Suitable for use in wet (outdoor direct rain or sprinkler) locations as defined by NEC and CEC. Constructed with 316 stainless steel. Rated for both indoor and outdoor use. IP67 outdoor rated. LED integrated components carry a 10-year limited warranty. Burial sleeve included.



15075 SS
SHOWN WITH INCLUDED BURIAL SLEEVE

PHOTOMETRIC GUIDE

15075 SS

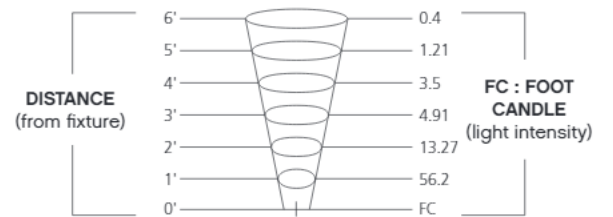

15085 SS
SHOWN WITH INCLUDED BURIAL SLEEVE

PHOTOMETRIC GUIDE

15085 SS

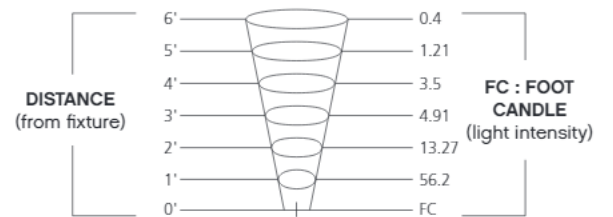

FLARE WELL LIGHTS

Flare's integrated LED indicator lighting is available in either small or large uni-directional well lights, as well as small or large quad-directional well light options to ensure success on every project. Constructed with heavy duty cast 316 stainless steel, a burial sleeve is included. Flare LED lights are drive-over rated up to 4000 lb.



INTEGRATED LED

Each energy-efficient fixture is equipped with a fully integrated LED panel and built-in driver.

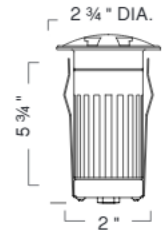

15710 SS
FLARE LED
UNI-DIRECTIONAL WELL LIGHT
2 3/4" DIA., 5 3/4" D

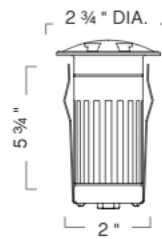

15740 SS
FLARE LED
QUAD-DIRECTIONAL WELL LIGHT
2 3/4" DIA., 5 3/4" D



 LED ITEM	MAX WATTAGE / VOLT AMPS	LUMENS	COLOR TEMP.	HALOGEN EQUIV.	LIFESPAN	FINISH	CONSTRUCTION	LENS
15710 SS	4w / 4.8VA	10	3000K	25w	40,000 hrs	Stainless Steel	Stainless Steel	Frosted
15740 SS	4w / 4.8VA	10	3000K	25w	40,000 hrs	Stainless Steel	Stainless Steel	Frosted

Suitable for use in wet (outdoor direct rain or sprinkler) locations as defined by NEC and CEC. Constructed with 316 stainless steel. Rated for both indoor and outdoor use. IP67 outdoor rated. LED integrated components carry a 10-year limited warranty. Burial/Concrete sleeve included.



15710 SS

PHOTOMETRIC GUIDE

15710 SS

ITEM	DISTANCE FEET	FC
15710 SS	1	2.05
	2	0.52
	3	0.25
	4	0.15

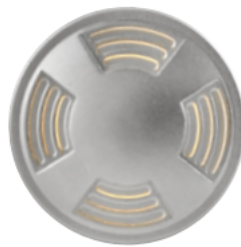

15740 SS

PHOTOMETRIC GUIDE

15740 SS

ITEM	DISTANCE FEET	FC
15740 SS	1	0.73
	2	0.18
	3	0.09
	4	0.04

FLARE WELL LIGHTS

Flare's integrated LED indicator lighting is available in either small or large uni-directional well lights, as well as small or large quad-directional well light options to ensure success on every project. Constructed with heavy duty cast 316 stainless steel, a burial sleeve is included. Flare LED lights are drive-over rated up to 4000 lb.



INTEGRATED LED

Each energy-efficient fixture is equipped with a fully integrated LED panel and built-in driver.

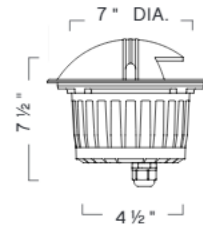
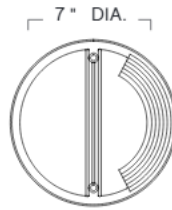

15712 SS
FLARE LED
UNI-DIRECTIONAL WELL LIGHT
7" DIA., 7 1/2" D

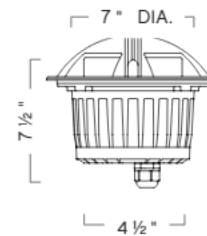
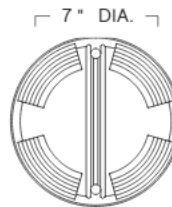
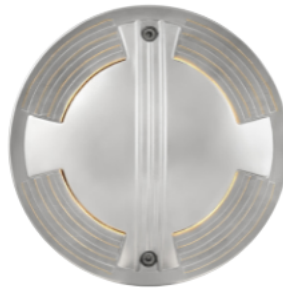

15742 SS
FLARE LED
QUAD-DIRECTIONAL WELL LIGHT
7" DIA., 7 1/2" D



 LED ITEM	MAX WATTAGE / VOLT AMPS	LUMENS	COLOR TEMP.	HALOGEN EQUIV.	LIFESPAN	FINISH	CONSTRUCTION	LENS
15712 SS	6w / 7.5VA	90	3000K	50w	40,000 hrs	Stainless Steel	Stainless Steel	Frosted
15742 SS	9.5w / 13VA	180	3000K	50w	40,000 hrs	Stainless Steel	Stainless Steel	Frosted

Suitable for use in wet (outdoor direct rain or sprinkler) locations as defined by NEC and CEC. Constructed with 316 stainless steel. Rated for both indoor and outdoor use. IP67 outdoor rated. LED integrated components carry a 10-year limited warranty. Burial/Concrete sleeve included.



15712 SS



PHOTOMETRIC GUIDE

15712 SS

ITEM	DISTANCE FEET	FC
15712 SS	1	23.81
	2	5.90
	3	3.81
	4	2.46
	5	1.47
	6	0.91
	7	0.39
	8	0.33



15742 SS

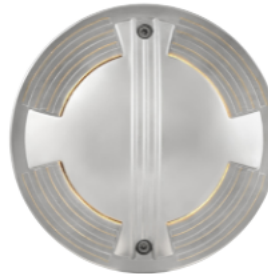

PHOTOMETRIC GUIDE

15742 SS

ITEM	DISTANCE FEET	FC
15742 SS	1	14.81
	2	4.21
	3	2.75
	4	2.16
	5	1.23
	6	0.58
	7	0.28
	8	0.15

DASH BRICK LIGHTS

Dash LED brick lights deliver sleek style, safety and security in a powerful package. Available in small and large sizes, as well as well as flat and louvered versions. Dash has a cast 316 stainless steel faceplate equipped with frosted glass for soft illumination.



INTEGRATED LED

Each energy-efficient fixture is equipped with a fully integrated LED panel and built-in driver.



DIMMABLE

Item is dimmable.

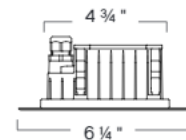
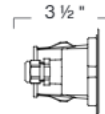
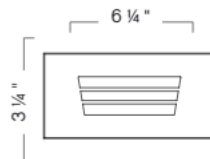
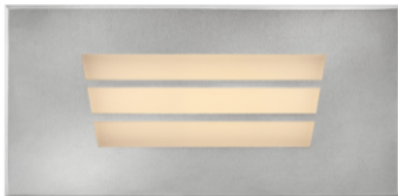

15334 SS
DASH LED SMALL
LOUVERED BRICK LIGHT
6 1/4" W, 3 1/4" H, 3 1/2" D

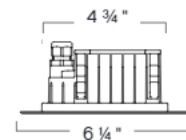
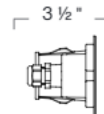
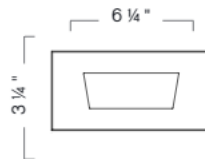

15344 SS
DASH LED SMALL
FLAT BRICK LIGHT
6 1/4" W, 3 1/4" H, 3 1/2" D



LED ITEM	MAX WATTAGE / VOLT AMPS	LUMENS	COLOR TEMP.	HALOGEN EQUIV.	LIFESPAN	FINISH	CONSTRUCTION	LENS
15334 SS	5w / 6.8VA	65	3000K	25w	40,000 hrs	Stainless Steel	Stainless Steel Faceplate	Frosted
15344 SS	5w / 6.8VA	65	3000K	25w	40,000 hrs	Stainless Steel	Stainless Steel Faceplate	Frosted

Suitable for use in wet (outdoor direct rain or sprinkler) locations as defined by NEC and CEC. Constructed with 316 stainless steel. Rated for both indoor and outdoor use. IP65 outdoor rated. LED integrated components carry a 10-year limited warranty. Mounting sleeve is required for installation.



15334 SS



15344 SS

PHOTOMETRIC GUIDE

15334 and 15344 SS (BASED ON VARIOUS MOUNTING HEIGHTS)

DISTANCE FROM LIGHT		ITEM	1'	2'	3'	4'	5'	6'	7'	8'	9'	10'	11'	12'
FOOT CANDLES	12" Front	15334 SS	4.84	1.89	0.76	0.35	0.21	0.12	0.1	0.06	0.04	0.03	0.02	0.01
	12" Side		0.41	0.09	0.01									
	18" Front		2.72	1.56	0.66	0.35	0.22	0.15	0.11	0.07	0.05	0.03	0.01	
	18" Side		0.42	0.13	0.01									
	12" Front	15344 SS	5.71	2.46	1.08	0.52	0.3	0.19	0.14	0.1	0.08	0.05	0.03	
	12" Side		0.32	0.12	0.02	0.01								
	18" Front		3.08	1.82	0.93	0.46	0.29	0.19	0.13	0.09	0.08	0.06	0.05	0.04
	18" Side		0.32	0.06	0.02	0.01								

DASH BRICK LIGHTS

Dash LED brick lights deliver sleek style, safety and security in a powerful package. Available in small and large sizes, as well as well as flat and louvered versions. Dash has a cast 316 stainless steel faceplate equipped with frosted glass for soft illumination.



INTEGRATED LED

Each energy-efficient fixture is equipped with a fully integrated LED panel and built-in driver.



DIMMABLE

Item is dimmable.

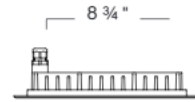
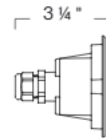
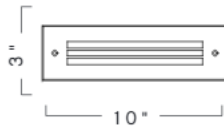

15335 SS
DASH LED LARGE
LOUVERED BRICK LIGHT
10" W, 3" H, 3 1/4" D

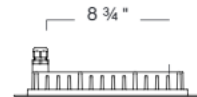
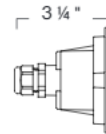
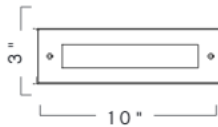

15345 SS
DASH LED LARGE
FLAT BRICK LIGHT
10" W, 3" H, 3 1/4" D



LED ITEM	MAX WATTAGE / VOLT AMPS	LUMENS	COLOR TEMP.	HALOGEN EQUIV.	LIFESPAN	FINISH	CONSTRUCTION	LENS
15334 SS	7w / 9.5VA	115	3000K	40w	40,000 hrs	Stainless Steel	Stainless Steel Faceplate	Frosted
15345 SS	7w / 9.5VA	115	3000K	40w	40,000 hrs	Stainless Steel	Stainless Steel Faceplate	Frosted

Suitable for use in wet (outdoor direct rain or sprinkler) locations as defined by NEC and CEC. Constructed with 316 stainless steel. Rated for both indoor and outdoor use. IP65 outdoor rated. LED integrated components carry a 10-year limited warranty. Mounting sleeve is required for installation.

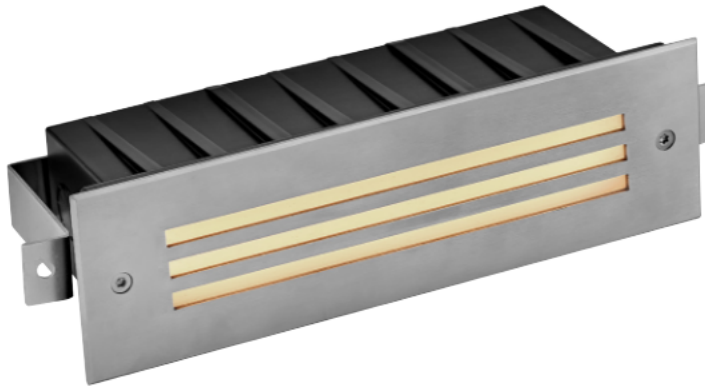

15335 SS

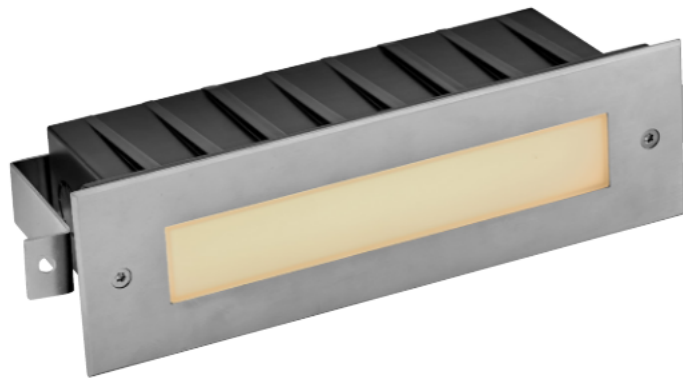

15345 SS

PHOTOMETRIC GUIDE

15335 and 15345 SS (BASED ON VARIOUS MOUNTING HEIGHTS)

DISTANCE FROM LIGHT		ITEM	1'	2'	3'	4'	5'	6'	7'	8'	9'	10'	11'	12'
FOOT CANDLES	12" Front	15335 SS	4.16	2.68	1.07	0.69	0.45	0.28	0.25	0.2	0.16	0.08	0.06	0.03
	12" Side		0.28	0.11	0.02	0.01								
	18" Front		1.6	1.54	0.95	0.6	0.38	0.29	0.23	0.18	0.15	0.11	0.09	
	18" Side		0.14	0.06	0.01									
	12" Front	15345 SS	9.65	4.14	2.27	1.06	0.64	0.44	0.35	0.27	0.23	0.13		
	12" Side		0.71	0.24	0.05	0.1								
	18" Front		4.81	3.08	1.93	1.1	0.82	0.49	0.33	0.27	0.22	0.16	0.13	
	18" Side		0.07	0.04	0.01									

TILT STEP/WALL LIGHTS

Tilt's modern integrated LED wall light is available in round or square options with cast 316 stainless steel housing and clear glass to cast a warm glow.



INTEGRATED LED

Each energy-efficient fixture is equipped with a fully integrated LED panel and built-in driver.



DIMMABLE

Item is dimmable.

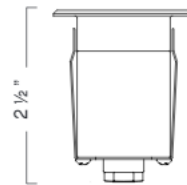
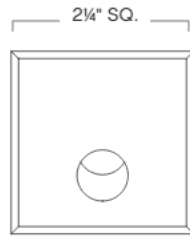

15242 SS
TILT LED SQUARE
STEP/WALL LIGHT
2 1/4" SQ., 2 1/2" D

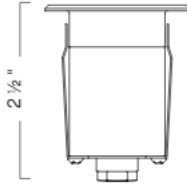

15252 SS
TILT LED ROUND
STEP/WALL LIGHT
2 1/4" DIA., 2 1/2" D



LED ITEM	MAX WATTAGE / VOLT AMPS	LUMENS	COLOR TEMP.	HALOGEN EQUIV.	LIFESPAN	FINISH	CONSTRUCTION	LENS
15242 SS	4w / 4.8VA	30	3000K	10w	40,000 hrs	Stainless Steel	Stainless Steel	Clear
15252 SS	4w / 4.8VA	30	3000K	10w	40,000 hrs	Stainless Steel	Stainless Steel	Clear

Suitable for use in wet (outdoor direct rain or sprinkler) locations as defined by NEC and CEC. Constructed with 316 stainless steel. Rated for both indoor and outdoor use. IP67 outdoor rated. LED integrated components carry a 10-year limited warranty. 4" burial sleeve included.

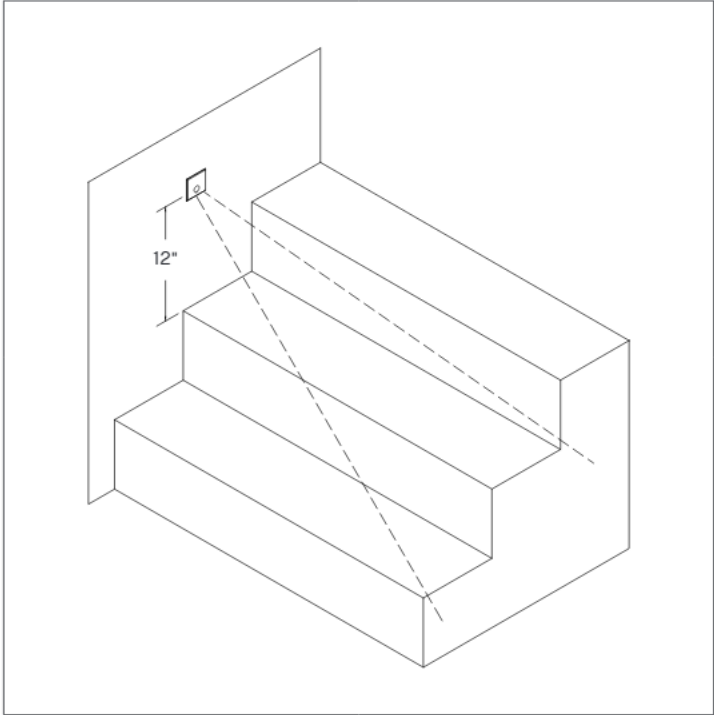

DESIGN NOTE

Exceptionally dimmable and directional light safely illuminates steps and walkways.



15242 SS



PHOTOMETRIC GUIDE

15242 SS

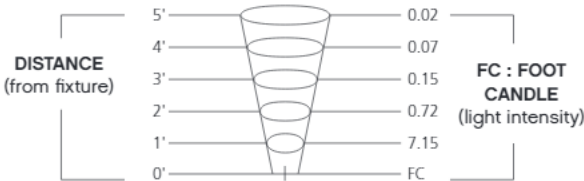

15252 SS



PHOTOMETRIC GUIDE

15252 SS

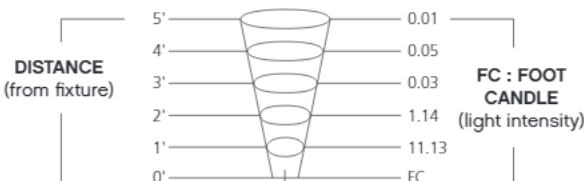

LANDSCAPE LIGHTING TECHNIQUES

Hinkley has you covered with every need-to-know method for lighting up the night.

SILHOUETTING

Also called backlighting, silhouetting is used to dramatize an interesting shaped object.

CREATING THIS EFFECT : A spot light is placed between the tree and the front of the home. The spot light is aimed at the front of the home creating a dramatic silhouette of the tree.



WALL WASHING

Wall washing is a technique that refers to the general illumination of a wall or surface.

CREATING THIS EFFECT : Spot lights are placed along the front of the home to create a soft wash of light.



SHADOWING

Shadowing is an effect created by placing a light source in front of an object and projecting a shadow onto a surface behind the object.

CREATING THIS EFFECT : Spot lights are placed directly in front of the tall bushes, producing shadows which are projected on the home's face, creating an interesting and inviting façade.



UPLIGHTING

Uplighting is illuminating an area, surface or object from below to create a focal point in the landscape.

CREATING THIS EFFECT : A spot light is aimed at the tree in the foreground while the front of the home remains relatively dark.





GRAZING

Grazing emphasizes a textured surface (such as a tree trunk, a stone wall, climbing ivy, etc.) by placing a light source within one foot of that surface and aiming the light beam parallel to that surface.

CREATING THIS EFFECT : Spot lights are placed beneath each stone pillar to create dimension, complementing the home's entryway.

DECK + PATIO LIGHTING

Step, brick and hardscape lighting can be used in masonry and wood constructions. These fixtures are specifically designed to provide safety and accent lighting while creating a warm atmosphere.

CREATING THIS EFFECT : A surface-mounted deck sconce is placed on the wall above each step to illuminate a safe entryway to the deck. A hardscape fixture under the bench, coupled with deck sconces mounted to the corner posts create a soft glow.



INDICATOR LIGHTING

Indicator lighting has numerous advantages to enhancing hard-to-light areas like driveways after dark. These heavy-duty fixtures are a low-profile, effective and modern solution.

CREATING THIS EFFECT : By installing recessed indicator lights into the concrete, they are safely anchored in place and can be added onto any existing low voltage landscape lighting system or installed with a new system.

STEP LIGHTING

Step and brick lights can be used in masonry and wood constructions. These fixtures are designed to safely illuminate stairways and walkways.

CREATING THIS EFFECT : The steps are gently illuminated leading up to the doorway to ensure safety.



PATH LIGHTING

Path and area lighting is used to enhance dynamic landscaping elements such as flower beds, shrubbery and borders while safely illuminating pathways.

CREATING THIS EFFECT : Path lights are staggered around the walkway to create pools of light that illuminate a safe passage to the home's entrance.

HINKLEY

HINKLEY.COM

GLOBAL HEADQUARTERS

33000 Pin Oak Parkway | Avon Lake, Ohio 44012
T 440 653 5500 | F 440 653 5555 | hinkley.com

SHOWROOMS

Dallas Trade Mart 3210 | Dallas, Texas 75207
High Point Historic Market Square 290 | High Point, NC 27260



Connect with us | #hinklestyle

2022 SPARTA LSSPARTA122

